



SUTER

Gültig ab:
1. März 2024
Valido dal:
1° marzo 2024

2024

Preisbuch | Catalogo prezzi

Preisbuch | Planungshandbuch Edelstahl-Massanfertigungen

Catalogo prezzi | Manuale di progettazione soluzioni a misura in acciaio inox

suter.ch

SUTER

Starke Marken für die Küche – Alles aus einer Hand Marchi forti per la cucina – tutto da un'unica fonte

Von der Edelstahl-Manufaktur bis zum Küchenausstatter mit einem umfassenden Produktfolio – Einzigartige Produkte und Top-Marken aus den Bereichen Massanfertigung, Spülen und Becken, Küchenzubehör, Armaturen, Abfallsysteme sowie Haushaltsgeräte von BORA, Samsung und LG. BORA wird neu im separaten **Preisbuch Haushaltsgeräte** ausgewiesen.

Da manifattura di acciaio inox a fornitore di cucine con un portafoglio di prodotti completo: prodotti unici e i migliori marchi nell'ambito delle realizzazioni su misura, dei lavelli, degli accessori per cucina, della rubinetteria, dei sistemi di raccolta rifiuti e degli elettrodomestici di BORA, Samsung e LG. BORA è ora presente nel **catalogo prezzi elettrodomestici** separato.

Preisbuch
Haushaltsgeräte
2024
Catalogo prezzi
elettrodomestici
2024



Werbemittelbestellung

Bestellen Sie unsere Preisbücher sowie Broschüren und Magazine auch online unter [suter.ch](https://www.suter.ch) oder per Email unter: werbemittelversand@suter.ch

Ordine di materiale pubblicitario

Ordinate i nostri cataloghi prezzi, opuscoli e riviste anche online su [suter.ch](https://www.suter.ch) o per e-mail all'indirizzo: werbemittelversand@suter.ch

Starke Marken für die Küche Marchi forti per la cucina

BORA

DORN
BRACHT

EVoline®

GESSI

GROHE

hansgrohe

KWC

LAUFEN

LG

MÜLLEREX®

SAMSUNG

SCHOCK

SUTER

Haushaltsgeräte in separatem Preisbuch 2024
Elettrodomestici nel catalogo prezzi 2024 separato

Alle aufgeführten Preise verstehen sich in CHF exkl. MWST / inkl. 8.1% MWST und als unverbindliche Preisempfehlung. Die vorgezogene Recyclinggebühr (VRG) ist jeweils separat exkl. MWST angegeben. Alle aktuellen Informationen sowie die Allgemeinen Geschäftsbedingungen finden Sie unter [suter.ch](https://www.suter.ch).

Tutte le indicazioni di prezzo devono intendersi in CHF, IVA escl. / incl. 8.1% e come prezzi consigliati non vincolanti. La tassa di riciclaggio anticipata (TRA) è sempre indicata separatamente senza IVA. Tutte le informazioni aggiornate e le Condizioni generali di vendita sono consultabili su [suter.ch](https://www.suter.ch).

Irrtümer, Druckfehler und technische Änderungen vorbehalten | Stand 01.2024 / Con riserva di errori, errori di stampa e modifiche tecniche | Stato al 01.2024

Schweizer Familienunternehmen
und Produktion
Impresa di famiglia e produzione svizzera

14



Schweizer Familienunternehmen
Impresa svizzera di famiglia

Planungshandbuch
Edelstahl-Massanfertigungen
Manuale di progettazione
soluzioni a misura in acciaio inox

30

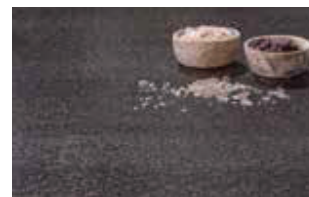

Massanfertigungen
Soluzioni a misura

Unterbau-Becken
Lavelli sottopiano

136

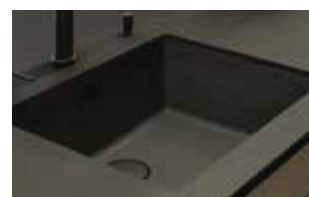

Unterbau-Becken
Lavelli sottopiano

Flächenbündige-Spülen/
Flachrand-Spülen
Lavelli a filo top/
Lavelli soprapiano

210



IF-Spülen
IF-Lavelli

Einlege-Spülen
Lavelli da incasso

288



Einlege-Spülen
Lavelli da incasso

Küchenzubehör
Accessori per cucina

309



Küchenzubehör
Accessori per cucina

Armaturen
Rubinetteria

316



Armaturen
Rubinetteria

Dispenser / Zugknöpfe
Distributori / Pomoli

352



Dispenser / Zugknöpfe
Distributori / Pomoli

Abfall-Systeme
Sistemi di raccolta rifiuti

361



Abfall-Systeme
Sistemi di raccolta rifiuti

Neue Akzente für die Küche

Nuovi accenti per la cucina



Spülen & Becken: Neue Modellreihe Linero – Edelstahl

Der enge Radius in den Ecken als auch am Boden verleiht Linero eine konsequent gleichmässige Optik und ein ausgeglichenes, elegantes und klares Design. Mit Linero setzen wir neue Massstäbe für zeitlose Eleganz, die selbst höchsten Designansprüchen gerecht wird.

Lavelli:

La nuova linea di modelli Linero – Acciaio inox

Il raggio stretto negli angoli e sul fondo conferisce a Linero un aspetto decisamente uniforme e un design equilibrato, elegante e lineare. Grazie a Linero stabiliamo nuovi standard per un'eleganza senza tempo e soddisfiamo anche le più elevate esigenze di design.

76



Spülen & Becken: Neue Modellreihe Linero – Cristadur

Linero Cristadur zeichnet sich durch sein Design und die seidig matte Oberfläche aus, welche dank einem verstärkten Abperleffekt leicht zu reinigen ist. Erhältlich in den drei Trendfarben Puro, Stone und Polaris. Passend dazu Desino in Graphit oder schwarz matt, welches sich farblich harmonisch in das Becken integriert.

Lavelli:

La nuova linea di modelli Linero – Cristadur

Linero Cristadur si distingue per il suo design e la sua superficie opaca e setosa, facile da pulire grazie all'effetto idrorepellente. Disponibile nei tre colori di tendenza Puro, Stone e Polaris. Abbinabile a Desino in grafite o nero opaco, che si fonde armoniosamente con il colore del lavello.

214

Beschichtete Ventilbestandteile / Pilette rivestite



Die Ventilbestandteile in der DEC-Beschichtung schwarz matt oder PVD-beschichtet in Graphit können gegen einen Mehrpreis passend dazu bestellt werden.

I componenti piletta con rivestimento DEC nero opaco o PVD in grafite possono essere ordinati a un costo aggiuntivo.

192 278



Setzen Sie schwarze Akzente in der Küche: Linero CD und Brooklyn – Black Edition

194

203

Für Linero und Brooklyn bieten wir neu eine einzige Bestellnummer für die Ausführung komplett in schwarz. Hier erhalten Sie das Becken, die Ventilbestandteile, Ablauftechnik und Zugknopf in einem Set zum Kombipreis.

Accentuate il nero in cucina: Linero CD e Brooklyn – Black Edition

Per Linero e Brooklyn, ora offriamo un unico numero d'ordine per la versione completamente nera. In questo modo ricevete il lavello, i componenti pileta, la tecnologia di scarico e il pomolo in un unico set a un prezzo combinato.



Ausbau Vantis Linie: Vantis mit Desino

257

Die Beckenlinie Vantis ist neu auch mit der innovativen Ablauftechnik Desino erhältlich.

Ampliamento della linea Vantis: Vantis con Desino

La linea di lavelli Vantis è ora anche disponibile con l'innovativa tecnologia di scarico Desino.



Ausbau Silver Star Linie: Neue Varix Modelle

Die bewährte Beckenlinie Silver Star wird neu durch zwei Varix Modelle ergänzt.

Ampliamento della linea Silver Star: nuovi modelli Varix

Ora due modelli Varix si aggiungono all'affermata linea di modelli Silver Star.

183

Neue Akzente für die Küche

Nuovi accenti per la cucina



Seien Sie gespannt auf neue Farben.
Besuchen Sie uns auf [suter.ch](https://www.suter.ch)
Non vedete l'ora di scoprire i nuovi colori?
Venite a trovarci su [suter.ch](https://www.suter.ch)



Oberflächen: Xrange Black

Mit Stolz präsentieren wir Ihnen unsere neue Xrange Black. Der charismatische Kreuzschliff ist neu in der Trendfarbe Black erhältlich und ergibt durch die Edelstahlstruktur ein einmaliges und dekoratives Farbenzusammenspiel, welche je nach Lichteinfall eine andere Erscheinung erhält.

Superfici: Xrange Black

È con grande orgoglio che presentiamo il nostro nuovo Xrange Black. L'esclusiva rettifica a croce di Xrange è ancora più elegante e leggera, grazie alla combinazione della superficie nera con la caratteristica struttura in acciaio inox argentato. Le eccellenti caratteristiche supportano l'aspetto accattivante, che si integra armoniosamente nel vostro progetto di cucina a seconda dell'incidenza della luce o dell'angolo di osservazione.

Oberflächen: 5 auf 4mm Materialstärke Spezialoberflächen

Bei den Spezialoberflächen wurde die Materialstärke von 5 auf 4mm gesetzt. Ebenso gibt es Veränderungen bei den Plattendimensionen. Die Übersicht finden Sie auf Seite 38.

Superfici: spessore del materiale da 5 a 4 mm Superfici speciali

Per quanto riguarda le superfici speciali, lo spessore del materiale è stato cambiato da 5 a 4 mm, così come le dimensioni delle lastre. La panoramica è riportata a pagina 38.



Oberflächen: Breitband Varix

Nebst unseren beliebten Standardoberflächen Seidenmatt-, Breitband- und Wirbel-Finish integrieren wir neu zusätzlich Breitband Varix. Mehr Infos in der Tabelle auf Seite 10.

Superfici: Varix a nastro largo

Oltre alle nostre apprezzate superfici standard con finitura opaca, a nastro largo e a turbino, ora c'è anche Varix a nastro largo. Maggiori informazioni nella tabella a pagina 10.

Neue Namensgebung / Nuova denominazione Dünnblech / Lamiera sottile: **SmartSteel Collection** Massiv / Lamiera massiccia: **SolidSteel Collection**

Bitte beachten Sie im neuen Preisbuch, dass Dünnblech und Massiv neue Bezeichnungen erfahren haben:

Dünnblech: **SmartSteel Collection**

Massiv: **SolidSteel Collection**

Vi preghiamo di notare che la lamiera sottile e la lamiera massiccia hanno nuovi nomi nel catalogo prezzi.

Lamiera sottile: **SmartSteel Collection**

Lamiera massiccia: **SolidSteel Collection**

Müllex D-Line



Clevere Abfalltrennsysteme für Ihre Küche: Neu mit praktischem Drehtüren-System.

Sistemi intelligenti di raccolta differenziata dei rifiuti per la vostra cucina: ora provvisti di sistemi a porte girevoli.

Starke Marken für die Küche

Marchi forti per la cucina

316

Wir erweitern unser Sortiment um 46 neue Armaturen / Ampliamo il nostro assortimento con 46 nuove rubinetterie



SUTER



GESSI



KWC



LAUFEN



DORN
BRACHT



hansgrohe

Varianteencode – Sie haben die Wahl

Codice variante: a voi la scelta

Mit dem Varianteencode bieten wir Ihnen mehr Kombinationsmöglichkeiten bei der Wahl der Ventile: Andere Zugknöpfe, andere Farben oder gleich beides? So funktioniert's:

Grazie al codice variante, vi offriamo più opzioni di combinazione nella scelta delle pilette: altri pomoli, altri colori o entrambi? Ecco come funziona:

Sie erkennen den **Standardlieferungsumfang** der Suter Spülen und Becken am erweiterten Artikelcode xx.xxx.xxx.00. Die Ventiltteile werden in Edelstahl geliefert, mit Zugknopf Advant, Prime oder Drehknopf.

Il codice articolo esteso xx.xxx.xxx.00 è un codice per riconoscere il **corredo di forniture standard** dei lavelli Suter. Le pilette sono fornite in acciaio inox, con pomolo Advant, Prime o pomolo girevole.

Variante .01



Austausch Zugknopf Sostituzione del pomolo

Bestellen Sie die Spülen oder Becken mit der Variantenerweiterung xx.xxx.xxx.01.

- Die Ventilbestandteile liefern wir in der Oberfläche Edelstahl.
- Austausch des Standard Zugknopfes mit dem Modell Ihrer Wahl (wählen Sie hier ein Modell mit der Erweiterung der Artikelnummer xx.xxx.xxx.01).
- Der Preis des Austausch-Zugknopfs reduziert sich um CHF 24.–.

Ordinate i lavelli con la variante estesa xx.xxx.xxx.01.

- Forniamo i componenti piletta con superficie in acciaio inox.
- Sostituzione del pomolo standard con un modello di vostra scelta (selezionate un modello con l'estensione del numero di articolo xx.xxx.xxx.01).
- Il prezzo del pomolo di ricambio si riduce di CHF 24.–.

Variante .02



Austausch Ventilbestandteile Sostituzione dei componenti piletta (Farbwechsel / cambio di colore)

Bestellen Sie die Spülen oder Becken mit der Variantenerweiterung xx.xxx.xxx.02.

- Die Ventilbestandteile mit der Oberfläche Edelstahl werden nach Ihrer Wahl ausgetauscht.
- Ersatz beschichtete Ventilbestandteile finden Sie auf Seite 192 und 198 (wählen Sie hier die Modelle mit der Artikelnummer xx.xxx.xxx.00).
- Die Preise beinhalten den Mehrpreis für die beschichteten Ventilbestandteile gegenüber des Standards mit Oberfläche Edelstahl.

Ordinate i lavelli con la variante estesa xx.xxx.xxx.02.

- I componenti piletta con superficie in acciaio inox vengono sostituiti in base alla vostra scelta.
- Trovate i componenti piletta sostitutivi con rivestimento a pagina 192 e 198 (selezionate qui i modelli con il numero di articolo xx.xxx.xxx.00).
- I prezzi includono il sovrapprezzo per i componenti piletta con rivestimento rispetto alla superficie standard in acciaio inox.

Variante .03

Austausch Zugknopf und Ventilbestandteile Sostituzione del pomolo e dei componenti piletta

Bestellen Sie das Becken mit der Variantenerweiterung xx.xxx.xxx.03 und Ihre gewünschten Bestandteile wie beschrieben bei den Varianten .01 und .02.

Ordinate il lavello con la variante estesa xx.xxx.xxx.03 e i componenti desiderati come descritto per le varianti .01 und .02.



Kombinieren – Profitieren

Approfittate delle combinazioni

Als einziger Partner der Schweiz bietet Ihnen Suter Inox AG die breiteste Palette verschiedenster Produkte der führenden Marken für den Küchenbau. Profitieren Sie von dieser Leistung, denn wir lassen Ihnen im wahrsten Sinne des Wortes die Wahl:

Bestellen Sie ein BORA Kochfeldabzugssystem und kombinieren Sie den Auftrag mit **beliebigen Produkten** aus unserem Sortiment. Dabei erweitern wir Ihre Grundkonditionen mit attraktiven Zusatzrabatten.

Weitere Informationen dazu finden Sie unter suter.ch mit Ihrem persönlichen Login.

Suter Inox AG è l'unico partner in Svizzera a offrirvi la più ampia gamma di prodotti dei marchi leader per la costruzione di cucine. Approfittate di questo servizio, perché vi diamo letteralmente la possibilità di scegliere:

Ordinate un sistema di aspirazione per piano di cottura BORA e combinate l'ordine con **qualsiasi prodotto** del nostro assortimento. Degli interessanti sconti aggiuntivi completano le vostre condizioni di base.

Ulteriori informazioni sono disponibili su suter.ch, accedendo con il vostro login personale.

Suter, il vostro fornitore di cucine: la vostra prima scelta per la cucina

Suter – Ihr Küchenausstatter – Ihre erste Wahl für die Küche



Bild- und Warenauswahl dienen nur als Beispiele
Immagini e selezione della merce sono solo esempi



Haushaltsgeräte in separatem Preisbuch 2024
Elettrodomestici nel catalogo prezzi 2024 separato

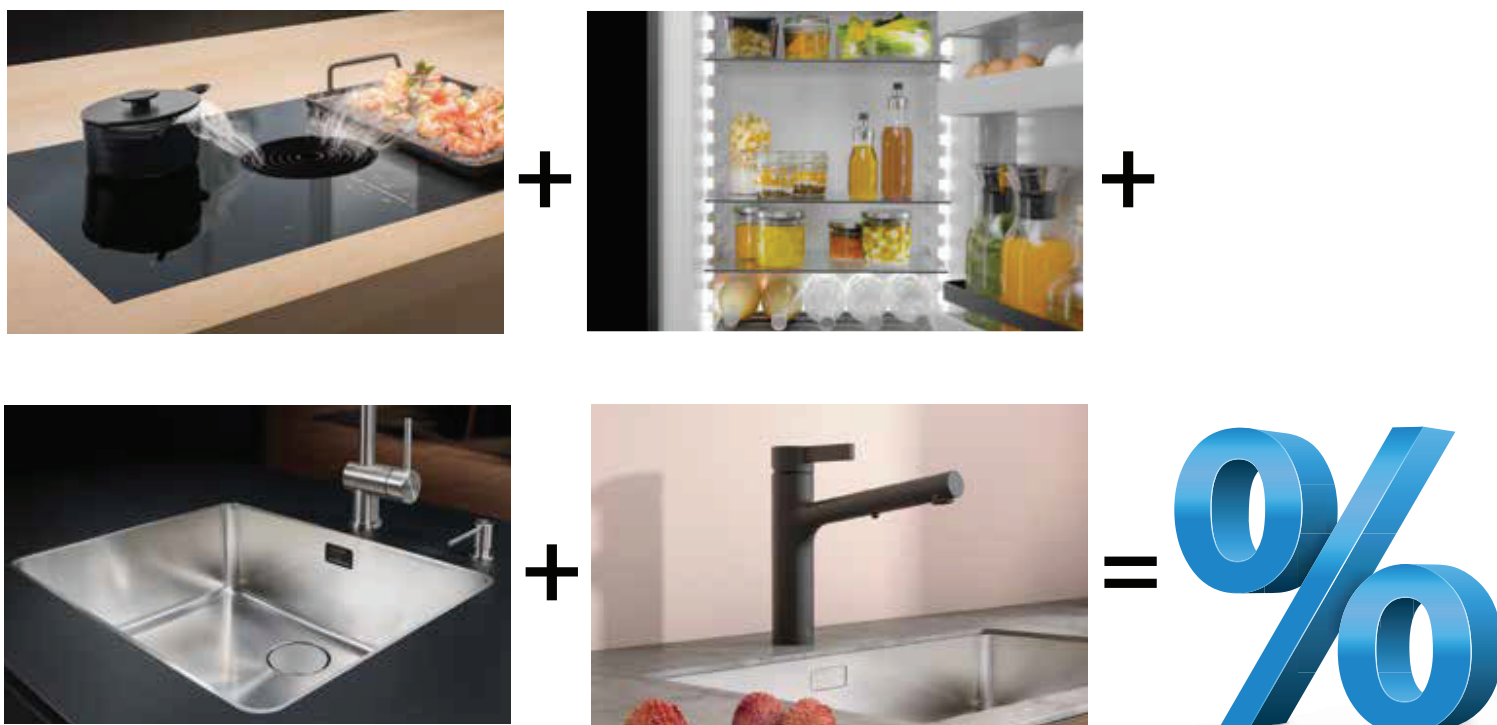

Werbemittelbestellung

Bestellen Sie unsere Preisbücher sowie Broschüren und Magazine auch online unter suter.ch oder per Email unter: werbemittelversand@suter.ch

Ordine di materiale pubblicitario





























Ordinate i nostri cataloghi prezzi, opuscoli e riviste anche online su suter.ch o per e-mail all'indirizzo: werbemittelversand@suter.ch

Edelstahl-Massanfertigungen: neue Auswahl an Varix-Ausführungen

Soluzioni su misura in acciaio inox: nuova selezione di modelli Varix

Varix-Ausführungen sind eine wirtschaftlich optimierte Variation der bekannten Standard-Ausführungen, sind perfekt auf die Nachfragesituation im Einstiegsbereich zugeschnitten, verfügen über ein sehr attraktives Preis-/Leistungsverhältnis und lassen sich mittels Baukastensystem einfach zur perfekt passenden Varix-Gesamtlösung kombinieren.

Le diverse versioni di Varix rappresentano una variante ottimizzata dal punto di vista economico delle note versioni standard, sono perfettamente adattate alla domanda nel segmento base, hanno un rapporto prezzo/prestazioni molto interessante e possono essere facilmente combinate utilizzando un sistema modulare per creare la perfetta soluzione completa Varix.

Produktbereich Settore di prodotti	Varix-Ausführung Versione Varix	Beschreibung Descrizione
Oberflächen Superfici	Breitband-Finish Varix  Finitura a nastro largo Varix 	Breitband-Finish Varix verfügt über eine charakteristische geradlinige und regelmässige Feinschliffstruktur. Der Schleiffaden ist etwas kürzer als beim klassischen Breitband-Finish. Bitte beachten sie die Schleifrichtungen Varix  La finitura a nastro largo presenta una caratteristica struttura a linee sottili e regolari. Il filo abrasivo è leggermente più corto rispetto alla classica finitura a nastro largo. Si prega di osservare le direzioni di levigatura di Varix 
Dimensionen Dimensioni	Alle Varix-Ausführungen  Tutte le versioni di Varix 	Maximale Dimension: 3900 x 1400mm Dimensioni massime: 3900 x 1400mm
Massanfertigungs-Formen Forme lavorate su misura	Alle Varix-Ausführungen  Tutte le versioni di Varix 	Einzeilig, zweizeilig, L-Winkel, U-Winkel, Kochinsel, Mehrteilig, überhängende Arbeitsplatte, Rück- und Seitenwände Su una linea, su due linee, a «L», a «U», isola di cottura, composita, piano di lavoro sporgente, schienali e fianchi
Randausführungen Bordature	A20 Varix  A30 Varix  A40 Varix  Quetschkante A20 Varix  Quetschkante A30 Varix  Quetschkante A40 Varix  A20 Varix  A30 Varix  A40 Varix  Bordo pressato A20 Varix  Bordo pressato A30 Varix  Bordo pressato A40 Varix 	Die Varix-Kantenausführungen sind unten sichtbar mit einer Kunstharz beschichteten, hellgrauen Spanplatte ausgestattet. Gegenüber den Standard-Ausführungen sind sie nicht gegenzugverleimt und die Kante hat einen 180°- Umbug. Alle Varix-Quetschkanten: nur einseitig (vorne) ausführbar. Le bordature di Varix sono visibilmente dotate di un pannello in truciolato grigio chiaro, rivestito di resina sintetica, nella parte inferiore. A differenza delle versioni standard, non sono retroincollate e il bordo ha una piega a 180°. Tutti i bordi pressati di Varix: disponibili con sagomatura solo su un lato (anteriore).
Zargenausführung Lavorazioni dei telai	Zarge H20 – H50 Varix  Zarge C30-8 – C50-8 Varix  Zarge C30-D-90° – C50-D-90° Varix  Zarge C30-D-90° – C50-D-90° hinten sichtbar Varix  Telaio H20 – H50 Varix  Telaio C30-8 – C50-8 Varix  Telaio C30-D-90° – C50-D-90° Varix  Telaio C30-D-90° – C50-D-90° visibile sul retro Varix 	Gegenüber den Standard-Ausführungen nur 1-seitig (hinten) ausführbar. Zargausführungen C30-D-90° – C50-D-90° Varix sind seitlich nicht geschlossen. Rispetto alle versioni standard, sono disponibili solo su un lato (posteriore). Le versioni di telaio C30-D-90° – C50-D-90° Varix non sono chiuse lateralmente.



Produktbereich Settore di prodotti	Varix-Ausführung Versione Varix	Beschreibung Descrizione
Beckenangebot Offerta lavelli	Vantis Varix Silver Star Varix Vantis Varix Silver Star Varix	Flächenbündig eingeschweisste Becken: Wir empfehlen unsere bestens bewährten Varix-Modelle der Modellreihen Vantis Varix und Silver Star Varix. Selbstverständlich steht wahlweise auch das komplette Beckenangebot gemäss dem vorliegenden Planungshandbuch zur Auswahl. Lavello termosaldato a filo top: consigliamo i nostri collaudati modelli Varix delle serie Vantis Varix e Silver Star Varix. Naturalmente, è possibile scegliere anche tra l'offerta completa di lavelli in base al presente manuale di progettazione.
Spüleneinpressungen Lavelli prestampati	Vantis Varix Vantis Varix	Wie empfehlen unsere Classic-Einpressungen in Kombination mit den Vantis Varix-Modellen. Die maximale Abdeckungstiefe beträgt 750mm. Alternativ steht das kompletten Spüleneinpressungs-Sortiment gemäss dem vorliegenden Planungshandbuch zur Auswahl. Consigliamo i nostri modelli prestampati Classic in combinazione con i modelli Vantis Varix. La profondità massima del rivestimento è di 750mm. In alternativa, è possibile scegliere tra l'intero assortimento di lavelli prestampati in base a questo manuale di progettazione.
Ausschnitte für Kochfelder Tagli per piani cottura	Für Kochfelder flächenbündig eingebaut Varix Für Kochfelder mit Auflagerahmen Varix Per piani cottura montati a filo top Varix Per piani cottura con telaio in appoggio Varix	Bei der Varix Ausführung für den flächenbündigen Einbau wird der Falz direkt in die Spanplatte gefräst und mit Kontaktklebstoff geschützt. Nella versione Varix per il montaggio a filo top, la piegatura è fresata direttamente nel pannello in truciolato e protetta con adesivo a contatto.
Rück- und Seitenwände Schienali e fianchi	Rück- und Seitenwände mehrteilig Varix Schienali e fianchi compositi Varix	Stärke: 11mm / Länge: bis 2500mm / Höhe: bis 1400mm Stärke: 20mm / Länge: bis 3900mm / Höhe: bis 1400mm Spessore: 11 mm / lunghezza fino a 2500mm / altezza: fino a 1400mm Spessore: 20 mm / lunghezza fino a 3900mm / altezza: fino a 1400mm
Ausschnitte, Schrägen und Rundungen Tagli, tagli inclinati e curvature	Diverse Ausführungen Diverse versioni	Angebot gemäss dem vorliegenden Planungshandbuch. Offerta in base al presente manuale di progettazione.
Verbindung von mehrteiligen Massanfertigungen Collegamento di superfici composite	Alle Varix-Ausführungen Tutte le versioni di Varix	mittels Stecknaht Stabilo tramite giunto a innesto Stabilo
Weitere Ausführungen Ulteriori versioni	Alle Varix-Ausführungen Tutte le versioni di Varix	Auf Anfrage su richiesta





Über uns	
Chi siamo	14
Servicegedanke	
Concetto di servizio	16
Nachhaltigkeit – Verantwortung für morgen	
Sostenibilità – La responsabilità per il domani	17
Edelstahl-Massanfertigungen	
Soluzioni su misura in acciaio inox	18
Einblick in unsere Produktion	
Una panoramica della nostre produzione	20
Werkstoff Edelstahl	
L'acciaio inox	22
Materialien, Oberflächenfinishes und Farben	
Materiali, finiture delle superfici e colori	24
Spülen und Becken	
Lavelli	25
Ablauf- und Überlauftechnik	
Sistema di troppopieno e scarico	26



V. l. n. r.: Marco Suter, Eveline Stutz-Suter und Alfred Suter.
Da sx a dx: Marco Suter, Eveline Stutz-Suter e Alfred Suter.

Das Schweizer Familienunternehmen

Die Zukunft beginnt jetzt. Wir investieren heute in die Zukunft von morgen. Um eine kontinuierliche Weiterentwicklung zu gewährleisten, bauen wir das Unternehmen stetig mit viel Elan und Passion weiter aus. Unser Hauptaugenmerk gilt der Weiter- und Neuentwicklung unserer innovativen Produkte, die an unserem Standort mit modernsten Anlagen, Technologien und aktuellsten Betriebssystemen gefertigt werden. Mit Herz und Leidenschaft investieren wir täglich in unsere Geschäftsbeziehungen – in unsere langjährigen Partner, treuen Kunden und Mitarbeiter.

In Schinznach-Bad und Zürich betreiben wir bereits erfolgreich zwei Ausstellungen. Wir haben das Jahr genutzt, um auch für unsere Kunden der Westschweiz schneller und einfacher erreichbar zu sein. **Ab Frühjahr 2024 heissen Sie unsere kompetenten Ansprechpartner in Crissier (VD) herzlich willkommen und zeigen Ihnen unsere starken Marken in der brandneuen Ausstellung. Wir freuen uns auf Ihren Besuch!**

Azienda svizzera a conduzione familiare

Il futuro inizia ora. Investiamo oggi nel futuro di domani. Per garantire un continuo sviluppo, espandiamo costantemente l'azienda con molto entusiasmo e passione. Il nostro obiettivo principale è quello di sviluppare e riprogettare i nostri prodotti innovativi, che vengono fabbricati presso la nostra sede utilizzando le più moderne attrezzature e tecnologie nonché i più recenti sistemi operativi. Ogni giorno investiamo con cuore e passione nelle nostre relazioni commerciali: nei nostri partner di lunga data, nei nostri clienti fedeli e nei nostri dipendenti.

Gestiamo già con successo due esposizioni a Schinznach-Bad e Zurigo. Abbiamo approfittato dell'anno in corso per rendere più semplice e veloce il contatto con i nostri clienti della Svizzera romanda. **Dalla primavera del 2024, i nostri interlocutori esperti saranno lieti di darvi il benvenuto a Crissier (VD) e vi mostreranno i nostri forti marchi nella nuovissima esposizione. Ci rallegriamo della vostra visita!**

Unser Engagement für morgen

Il nostro impegno per il domani

Das Kundenerlebnis steht im Zentrum

Nichts überzeugt mehr als die samtige Wärme von handgewärmtem Edelstahl live zu erleben. Testen Sie elegante Armaturen-Ausführungen, bestaunen Sie die Ruhe hocheffizienter BORA-Abzüge, umwerfend geräumige Food Center, unerwartete Features, Dampföfen-Technologien, die träumen lassen und jedes Gericht zum Genuss erheben. Erleben Sie unsere massgefertigten Unikate aus Schweizer Handarbeit sowie unsere starken Marken für die Küche live vor Ort. Vereinbaren Sie telefonisch einen Beratungstermin – auch ausserhalb unserer Öffnungszeiten möglich. Unsere kompetenten Mitarbeiter freuen sich auf Ihren Besuch!

Diamo grande importanza all'esperienza del cliente

Non c'è niente di più convincente che provare il calore vellutato dell'acciaio inox riscaldato a mano. Testate gli eleganti design della rubinetteria, ammirate la silenziosità delle cappe aspiranti BORA come pure i Food Center incredibilmente spaziosi, le caratteristiche inaspettate e la tecnologia dei forni a vapore, che fanno sognare e rendono ogni piatto un piacere per il palato. Scoprite di persona i nostri prodotti personalizzati e unici di fabbricazione svizzera nonché i nostri marchi forti per la cucina. Fissate telefonicamente un appuntamento per una consulenza, possibile anche al di fuori dei nostri orari di apertura. Il nostro personale sarà lieto di darvi il benvenuto!

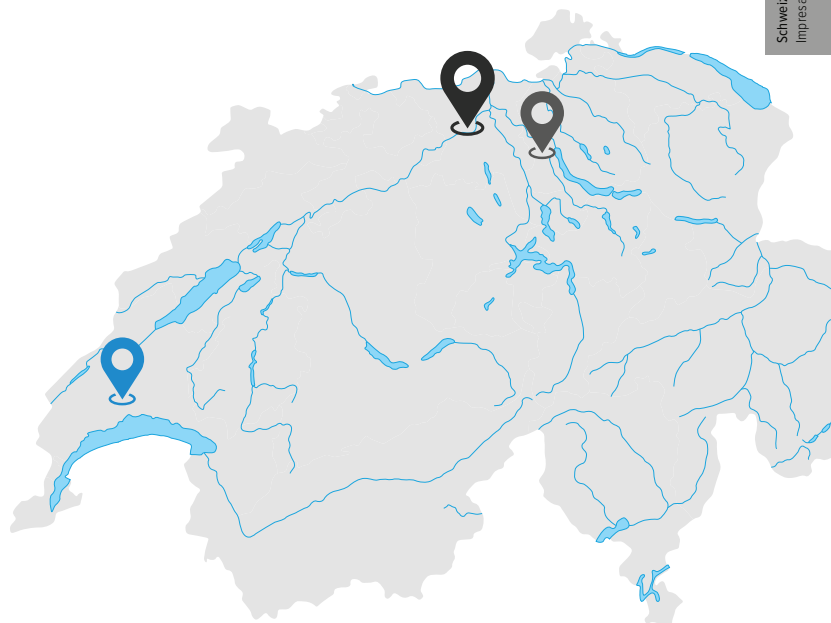

Hauptsitz, Produktionsstandort und Ausstellung Schinznach-Bad

Sede centrale, sito di produzione e Esposizione Schinznach-Bad
Schachenstrasse 20
CH-5116 Schinznach-Bad
T +41 58 263 64 00



Filiale und Ausstellung Zürich

Filiale e esposizione di Zurigo
Hardturmstrasse 125
CH-8005 Zürich
T +41 58 263 64 02



Filiale und Ausstellung Crissier

Filiale e esposizione di Crissier
Chemin des Lentillières 15
CH-1023 Crissier
T +41 58 263 64 03

1947: Entscheidender Schritt /

un passo decisivo

Alfred Suter sen. macht sich selbstständig und gründet das Unternehmen.

Alfred Suter senior si rende indipendente e fonda l'azienda.

2004: In neuem Glanz / con rinnovato slancio

Aus der Suter Spültischwerk GmbH wird Suter Inox AG, Eröffnung der Ausstellung in Schinznach-Bad.

Trasformazione della Suter Spültischwerk GmbH in Suter Inox AG, inaugurazione dell'esposizione a Schinznach-Bad.

2024:

Eröffnung Ausstellung Crissier /
apertura della filiale di Crissier

Ab Frühjahr 2024 erleben Sie unsere Produkte hautnah in der neuen Filiale in der Westschweiz.

Dalla primavera del 2024, potete sperimentare da vicino i nostri prodotti nella nuova filiale della Svizzera romanda.

1950

1960

1970

1980

1990

2000

2010

2020

2030

1967: Neuer Standort / nuova sede

Eröffnung Werk Schinznach-Bad. Vervielfachung der Produktionskapazitäten, Ausbau des Angebots.

Inaugurazione dello stabilimento di Schinznach-Bad, con conseguente moltiplicazione delle risorse produttive e ampliamento dell'offerta.

2022: Eröffnung Filiale Zürich /

apertura della filiale di Zurigo
Die grosse Ausstellung in Zürich wird eröffnet. Inspiration und Produkteerlebnis live vor Ort.

Aprire la grande esposizione di Zurigo. Per farsi ispirare e vivere in prima persona i prodotti direttamente sul posto.

Starke Marken für die Küche – alles aus einer Hand

Marchi forti per la cucina: tutto da un'unica fonte

BORA

DORN
BRACHT

EVoline®

GESSI

GROHE

hansgrohe

KWC

LAUFEN

LG

MÜLLEREX®

SAMSUNG

SCHOCK

SUTER

Haushaltsgeräte in separatem Preisbuch 2024
Elettrodomestici nel catalogo prezzi 2024 separato



Persönliche Beratung vor Ort oder Ausstellung

Wir beraten Sie gerne persönlich vor Ort oder in unseren Ausstellungen.

Consulenza sul posto o presso l'esposizione

Siamo lieti di consigliarvi personalmente sul posto o presso le nostre esposizioni.



Kundendienst Servicezentrum

Engagiert, kompetent und vielsprachig. Vor und nach dem Kauf sind wir für Sie da.

Servizio clienti Centro servizi

Impegnato, competente e multilingue. Siamo a vostra completa disposizione prima e dopo l'acquisto.



Digitales Servicezentrum

Kundenportal, Produktfinder, Downloads, News und spannende Blogs.

Centro servizi digitale

Portale clienti, ricerca prodotti, download, notizie e blog interessanti.



Ausmessen und Montage vor Ort

Auf Wunsch übernehmen wir das Ausmessen und die Montage der Edelstahl-Massanfertigung direkt vor Ort.

Misurazioni e montaggio in loco

Su richiesta, ci occupiamo delle misurazioni e dell'installazione della vostra soluzione personalizzata in acciaio inox direttamente sul posto.



Direktlieferung auf die Baustelle

Wir liefern Ihre Bestellung sicher, termin- und fachgerecht an die gewünschte Adresse.

Consegna diretta a piè d'opera

Consegniamo il vostro ordine in modo sicuro, puntuale e professionale all'indirizzo desiderato.



Service Techniker / Serviceorganisation

Unsere erfahrenen Servicetechniker haben für Sie das passende Ersatzteil immer dabei. Und das schweizweit.

Tecnici dell'assistenza / organizzazione di assistenza

I nostri tecnici dell'assistenza esperti hanno sempre con sé i pezzi di ricambio adatti per voi, in tutta la Svizzera.

Leiden- schaft für Ihre Küche

La passione per la vostra cucina



Kundendienst:

T +41 58 263 64 80 / kundendienst@suter.ch

Servizio clienti:

T +41 58 263 64 80 / servizioclienti@suter.ch

Nachhaltiges Denken und Handeln

Die Suter Inox AG übernimmt Verantwortung. Wir haben bei all unserem Tun und Handeln die zukünftigen Generationen im Blick. Nachhaltigkeit, Umweltschutz, Arbeitssicherheit und Gesundheitsschutz sind daher integrale und wesentliche Bestandteile unserer Identität. Als Kunde entscheiden Sie sich bei der Wahl eines Suter Produktes für langlebige und nachhaltige Qualität sowie ökologisch verantwortungsvolle Herstellung.

Unsere Produkte sollen den Nutzern einen sicheren und verantwortungsvollen Umgang mit den Ressourcen ermöglichen. Darüber hinaus wird schon bei der Gestaltung und Entwicklung der gesamte Produktlebenszyklus berücksichtigt, indem unsere Produkte sicher, Ressourcen schonend und langlebig konstruiert werden.

Pensare e agire in modo sostenibile

Suter Inox AG si assume le proprie responsabilità. In tutto ciò che facciamo, teniamo conto delle generazioni future. È quindi ovvio che sostenibilità, difesa dell'ambiente, sicurezza sul lavoro e tutela della salute siano parti integranti e indispensabili della nostra identità. Di conseguenza, in veste di clienti e scegliendo un prodotto Suter, vi schierate anche a favore di una qualità duratura e sostenibile e una produzione ecologicamente responsabile.

I nostri prodotti devono consentire agli utenti di gestire le risorse in modo sicuro e responsabile. Inoltre, l'intero ciclo di vita del prodotto viene preso in considerazione fin dalla fase di progettazione e sviluppo: i nostri prodotti sono progettati per essere sicuri, a basso consumo di risorse e durevoli.

Unsere Verantwortung für morgen

La nostra responsabilità per il domani





Ein echtes Plus: Massarbeit aus Edelstahl

Qualität, die man sieht und spürt. Von der Küchenabdeckung mit integriertem Wasserzentrum über Rückwände bis hin zu komplexen Formen setzen wir alles daran, die Visionen unserer Kunden wahr werden zu lassen. Dabei entstehen mit viel handwerklichem Geschick und der Passion für den Werkstoff Edelstahl unverwechselbare Einzelstücke von herausragender Qualität. Viele davon werden in Schweizer Handarbeit geschliffen oder poliert, damit sie am Schluss unseren hohen Qualitätsanforderungen gerecht werden.

Un vero vantaggio: lavoro su misura in acciaio inox

La qualità che si vede e che si sente. Dai piani di lavoro con punto idrico integrato e dai pannelli posteriori fino alle forme più complesse, facciamo del nostro meglio per realizzare le visioni dei nostri clienti. Tanta maestria artigianale e passione per il materiale acciaio inox danno vita a pezzi unici ed esclusivi di qualità eccellente. Molti di essi vengono levigati o lucidati a mano in Svizzera per soddisfare i nostri rigorosi requisiti qualitativi.

Erste Wahl für die Küche

La prima scelta per la cucina

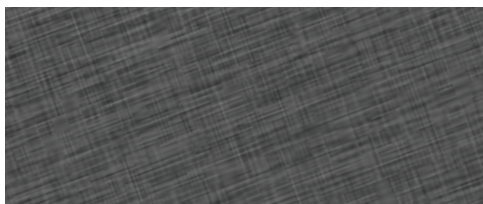

Unsere Oberflächen

Unsere Auswahl an Edelstahl-Oberflächen reicht vom klassischen Finish über extravagante Strukturen bis hin zu echten Unikaten wie der BlackRange-Oberfläche.



sTec Beschichtung

Wir sagen Fingerabdrücken auf Edelstahl den Kampf an. Für ausgewählte Oberflächen bieten wir mit sTec eine hochwertige Easy-to-Clean und Antifingerprint-Beschichtung an.



Massanfertigungs-Formen

Individualität ist unsere Stärke. In unserer Edelstahl-Manufaktur fertigen wir nahezu jede Küchen-Form.



Randausführungen

Die Kante ist ein wichtiges Gestaltungsmerkmal und trägt im Zusammenspiel mit dem Küchenmöbel wesentlich zum Erscheinungsbild bei. Deshalb bieten wir je nach Oberfläche unterschiedliche Kantendesigns und Ausführungen an.



Wasserzentrum

In der Küche ist Hygiene wichtig. Unsere nahtlos eingeschweissten Spülen und Becken erfüllen diesen Anspruch und sehen dabei auch noch richtig gut aus.



Rück- und Seitenwände

Rück- oder Seitenwände aus Edelstahl ergänzen die horizontale Arbeitsfläche ideal dank fugenlosem Design und schützen so die dahinter liegende Wand vor Verunreinigungen.



Kochfelder und Ausschnitte

Egal ob Kochfelder, Steckdosen oder weitere Komponenten. Für den passenden Einbau nehmen wir die erforderlichen Ausschnitte vor.



Spezialitäten

Unsere Edelstahl-Manufaktur lässt praktisch keine Wünsche offen. Gerne beraten wir Sie über die vielfältigen Möglichkeiten.



Serviceleistungen

Mit unseren Serviceleistungen reduzieren Sie Fehlerrisiken und sparen erst noch Zeit. Auf Wunsch übernehmen wir das Ausmessen und die Montage der Edelstahl-Massanfertigung direkt auf der Baustelle.

Le nostre finiture superficiali

La nostra selezione di superfici in acciaio inox spazia da finiture classiche e strutture stravaganti ad articoli veramente unici come la superficie BlackRange. Ce n'è davvero per tutti i gusti.

Rivestimento sTec

Abbiamo dichiarato guerra alle impronte digitali sull'acciaio inox. Per superfici selezionate proponiamo sTec, un rivestimento di alta qualità, facile da pulire e antim-pronta (Easy-to-Clean e Antifingerprint).

Forme delle soluzioni su misura

L'individualità è il nostro punto di forza. Nella nostra manifattura di acciaio inox produciamo quasi tutte le forme per la cucina.

Bordature

Il bordo è una caratteristica importante del design e dà un contributo significativo all'aspetto dei mobili della cucina. Ecco perché offriamo bordi con diversi design e versioni, a seconda della superficie.

Punto idrico

L'igiene è importante in cucina. I nostri lavelli termosaldati soddisfano questo requisito e sono anche di bella presenza.

Schienali e fianchi

Gli schienali e i fianchi in acciaio inox completano idealmente il piano di lavoro orizzontale grazie al loro design senza giunti e proteggono la parete retrostante da una possibile contaminazione.

Piani di cottura e tagli

Che si tratti di piani cottura, prese o altri componenti: facciamo i tagli necessari per agevolare il montaggio.

Esecuzioni speciali

La nostra manifattura di acciaio inox risponde praticamente a ogni esigenza. Saremo lieti di consigliarvi sulle numerose possibilità.

Prestazione di servizi

Con le nostre prestazioni di servizi riducete al minimo il rischio di errori e risparmiate tempo prezioso. Su richiesta, ci assumeremo noi la responsabilità delle misurazioni e del montaggio della vostra soluzione personalizzata in acciaio inox direttamente in cantiere.

Mit Herz und Hand am Werk

Wir lieben, was wir tun. Das Verarbeiten von Edelstahl ist unser Ursprung und der Herzschlag unserer Edelstahl-Manufaktur (rechts) und Fertigung Spülen und Becken (unten). Wir gehören zu den führenden Edelstahlspezialisten im privaten Küchenmarkt und greifen auf eine langjährige Erfahrung zurück, die wir aktiv in die heutigen Entwicklungen einbringen. So leben wir Tradition und Innovation Tag für Tag.

Un lavoro fatto con il cuore e le mani

Amiamo quello che facciamo. Le nostre origini affondano nella lavorazione dell'acciaio inox, mentre il nostro cuore batte per la nostra manifattura di acciaio inox (a destra) e la produzione di lavelli (sotto). Siamo uno dei principali specialisti nell'ambito dell'acciaio inox per quanto riguarda il mercato delle cucine private e vantiamo molti anni di esperienza, che mettiamo attivamente a frutto per gli sviluppi odierni. Ecco come viviamo la tradizione e l'innovazione giorno dopo giorno.

Modernste Fertigungsanlagen für Spülen und Becken

Täglich verlassen Hunderte von Spülen und Becken unsere Fertigung, welche alle vom Blechzuschnitt bis hin zur Qualitätskontrolle einen effizienten Fertigungsprozess durchlaufen. Dabei setzen wir auf modernste Robotertechnik kombiniert mit handwerklichem Geschick.

Impianti di produzione all'avanguardia per lavelli

Ogni giorno, centinaia di lavelli lasciano i nostri impianti di produzione dopo essere passati attraverso un efficiente processo produttivo: dal taglio della lamiera al controllo della qualità. Ci serviamo della più recente tecnologia robotica combinata con un'abile maestria artigianale. Siamo particolarmente orgogliosi del nostro processo di formatura.

Schweizer Handwerk für die Küche

Artigianato svizzero per la cucina



Tiefziehen und Umschneiden

Durch das energiesparende Kaltverfahren des Tiefziehens (ohne den Einsatz von zusätzlicher Hitze) fertigen wir aus Edelstahl-Blech die Becken als Einzelteil an. Mit diesem Produktionsverfahren sorgen wir dafür, dass das Ökosystem so wenig wie möglich belastet wird.

Imbutitura e taglio su misura

Grazie al processo d'imbutitura a freddo a basso consumo energetico (senza calore aggiuntivo), produciamo lavelli con la lamiera di acciaio inox come parti individuali e garantiamo che l'ecosistema sia sollecitato il meno possibile.



Stanzan und Formen

Im Zusammenspiel von traditionellem Knowhow und Robotik entstehen präzise Ablauf- und Überlauflochungen in Serie.

Stampi e forme

La combinazione di know-how tradizionale e robotica ci permette di produrre in serie perforazioni precise per lo scarico e il troppopieno.



Polieren

Die Eck- und Bodenrädien glänzen – ob auf herkömmlichen, einfachen Polieranlagen oder durch eine von uns entwickelte Spezialanlage gesteuert – selbstverständlich auch in mattem Finish.

Lucidatura

I raggi angolari e inferiori brillano: sia grazie a semplici macchine di lucidatura convenzionali che tramite una speciale macchina sviluppata da noi. Naturalmente lo stesso vale anche per una finitura opaca.



Endkontrolle

Vor der Auslieferung wird jede Spüle und jedes Becken einer Qualitätskontrolle unterzogen. Die Spülen und Becken werden im Anschluss fachmännisch verpackt und eingelagert.

Controllo finale

Prima della consegna, ogni lavello viene sottoposto a un controllo di qualità. In seguito, i lavelli vengono imballati e immagazzinati in modo professionale.



Unverwechselbare Einzelstücke, hergestellt in Handarbeit

Von der Küchenabdeckung mit integriertem Wasserzentrum über Rückwände bis hin zu komplexen Formen setzen wir alles daran, die Visionen unserer Kunden wahr werden zu lassen. Dabei entstehen mit viel handwerklichem Geschick und der Passion für den Werkstoff Edelstahl unverwechselbare Einzelstücke.

Inconfondibili pezzi unici, frutto di un'accurata lavorazione manuale

Dai piani di lavoro con punto idrico integrato e dai pannelli posteriori fino alle forme più complesse, facciamo del nostro meglio per realizzare le visioni dei nostri clienti. Tanta maestria artigianale e passione per il materiale acciaio inox danno vita a pezzi unici ed esclusivi.



Schneiden

Edelstahl wird dank seiner Legierungen für seine Härte, Korrosionsbeständigkeit und Langlebigkeit geschätzt. Aufgrund dieser Eigenschaften lässt sich das Material nur mit hochwertigen Plasma- oder Laserschneidern trennen.

Taglio

Grazie alle sue varie leghe, l'acciaio inox è apprezzato per la sua durezza, resistenza alla corrosione e durata. Queste proprietà fanno sì che per fendere questo materiale si debba ricorrere al taglio al plasma o al laser di alta qualità.



Schweissen

Wer Edelstahl schweissen möchte, braucht hohe Materialkenntnisse und vertieftes Wissen in unterschiedlichsten Schweissverfahren.

Saldatura

Chi ha voglia di saldare l'acciaio inox, deve conoscere bene i metalli e avere conoscenze approfondite nei diversi processi di saldatura.



Der Oberflächenfinish

Der Finish verleiht der Edelstahl-Oberfläche seine einzigartigen Eigenschaften – Glanz und maximale Reflexionskraft. Viele Oberflächen werden in Handarbeit geschliffen oder poliert, damit sie unseren hohen Qualitätsanforderungen entsprechen.

Finitura delle superfici

La finitura conferisce alla superficie dell'acciaio inox le sue proprietà uniche, come la lucentezza e un notevole potere riflettente. La maggior parte delle superfici viene levigata o lucidata a mano per soddisfare i nostri rigorosi requisiti qualitativi.

Faszination Edelstahl

Die Faszination, die vom Werkstoff Edelstahl ausgeht, zieht uns seit Generationen in ihren Bann. Das Material Edelstahl hat viele Gesichter und sorgt für grenzenlose Freiheit bei der Raumgestaltung. Seine hygienischen und funktionalen Vorzüge sind legendär. Und seine unschlagbare Ästhetik im Zusammenspiel mit anderen Materialien verleiht jeder Küche individuelle Klasse. Die kompromisslose Umsetzung individueller Kundenwünsche ist die schönste Herausforderung für unsere Edelstahl-Manufaktur. Wir fertigen die Edelstahlkomponenten jedes Küchenkonzeptes mit echter Leidenschaft und grösster Handwerkskunst an. Die in Schinznach-Bad gefertigten Edelstahl-Massanfertigungen sind Schmuckstücke, die höchste Schweizer Qualitätsmassstäbe erfüllen.

Il fascino dell'acciaio inox

Da generazioni, l'acciaio inox esercita un certo fascino su di noi. Questo materiale ha molte sfaccettature e offre una libertà illimitata nella progettazione degli interni. I suoi pregi igienici e funzionali sono leggendari. La sua estetica unica entra in armonia con gli altri materiali e conferisce a ogni cucina una classe individuale. Realizzare senza compromessi i desideri individuali dei clienti è la sfida più bella per la nostra manifattura di acciaio inox. Realizziamo i componenti in acciaio inox di ogni progetto di cucina con autentica passione e grande maestria artigianale. Le soluzioni su misura in acciaio inox realizzate a Schinznach-Bad sono gioielli che soddisfano i più alti standard di qualità svizzeri.

Das Material Edelstahl

Il materiale acciaio inox



Der Feinschliff macht den Unterschied

Eher matt oder doch lieber glänzend? Welche Farbnuance und Struktur darf es sein? Schliff und Finish bestimmen den optischen Gesamteindruck und den individuellen Charakter jeder einzelnen in aufwändiger Handarbeit gefertigten Edelstahl-Abdeckung. Unsere unvergleichlich umfangreiche Palette an Standard-, Decor- und Spezialoberflächen bietet bei der Konzeption und Gestaltung jeder Küche grenzenlose Freiheit.

Neben dem Feinschliff fertigen wir ganz nach den Kundenwünschen nahezu jede Küchen-Form. In der hauseigenen Edelstahl-Manufaktur trifft Leidenschaft auf Kompetenz. Übrigens: BlackRange und IceDesign™ sind echte Unikate. Hier kann der einzigartige Rohstahl in unserer Edelstahl-Manufaktur selbst ausgewählt werden.

Le rifiniture fanno la differenza

Preferite una finitura opaca o lucida? Quale tonalità di colore e struttura prediligete? La lucidatura e la finitura determinano l'aspetto visivo generale e il carattere individuale di ogni singolo rivestimento in acciaio inox realizzato pazientemente a mano. La nostra vasta e impareggiabile gamma di superfici Standard, Decor e speciali vi offre una libertà illimitata nella progettazione e nell'allestimento della vostra cucina.

Oltre alle rifiniture, realizziamo i desideri dei clienti per quanto riguarda quasi tutte le forme per la cucina. Nella nostra manifattura di acciaio inox combiniamo la passione con la competenza. A proposito: BlackRange e IceDesign sono sinonimo di pezzi unici. Voi stessi potete scegliere l'acciaio grezzo unico nella nostra manifattura di acciaio inox.



Die Vorteile von Edelstahl

I vantaggi dell'acciaio inox



Langlebigkeit

Edelstahl ist enorm langlebig, robust und weitgehend korrosionsbeständig.



Hochwertiger Edelstahl

Unser Rohmaterial von europäischen Lieferanten durchläuft eine strenge Qualitätskontrolle, bevor es verarbeitet wird.



Hygienisch

In Sachen Hygiene ist Edelstahl in der Küche nahezu unschlagbar. Auf der porenfreien Oberfläche sind Schmutz und Bakterien chancenlos.



Zeitlose Optik

Sein edles Aussehen behält Edelstahl beinahe ewig. Gebrauchsspuren, die mit der Zeit entstehen, verleihen dem Material eine schöne, werterhaltende Patina.



Reinigungsfreundlich

Edelstahl lässt sich mit den richtigen Mitteln sehr einfach pflegen und reinigen. Perfekt für alle, die es unkompliziert mögen.



100% recycelbar

Rostfreier Stahl lässt sich ohne Qualitätsverlust vollständig recyceln. Da freut sich die Umwelt. Und wir uns auch.

Lunga durata nel tempo

L'acciaio inox è estremamente durevole, robusto e molto resistente alla corrosione.

Acciaio di altissima qualità

La nostra materia prima proveniente da fornitori europei passa attraverso un rigoroso controllo di qualità prima di essere lavorata.

Igienico

Per quanto riguarda l'igiene, l'acciaio inox è praticamente imbattibile in cucina. Lo sporco e i batteri non hanno alcuna possibilità sulla sua superficie non porosa.

Estetica intramontabile

L'acciaio inox mantiene il suo raffinato aspetto quasi in eterno. I segni dell'usura che compaiono nel tempo conferiscono al materiale una splendida patina che preserva il suo valore.

Di facile manutenzione

Utilizzando i prodotti giusti, l'acciaio inox è molto facile da curare e pulire: perfetto per chi ama la semplicità.

Riciclabile al 100 %

L'acciaio inox può essere completamente riciclato senza alcuna perdita di qualità: un beneficio per l'ambiente e anche per noi.

Die richtige Pflege macht den Unterschied

Edelstahl ist ein sehr hochwertiges Material und behält über Jahre ein neuwertiges Aussehen. Für eine optimale Reinigung und Pflege bieten wir eine Auswahl an geeigneten Produkten an.

La cura giusta fa la differenza

L'acciaio inox è un materiale di alta qualità e il suo aspetto rimane come nuovo per molti anni. Offriamo una selezione di prodotti adatti a una pulizia e manutenzione ottimali.



Zu den Reinigungs- und Pflegeprodukten
Vai ai prodotti per pulizia e manutenzione



Materialien, Oberflächenfinishs und Farben

Materiali, finiture delle superfici e colori



Edelstahl, matt oder glänzend

Edelstahl ist in der Schweiz nach wie vor die beliebteste Wahl für das Becken oder die Spüle in der Küche. Er ist strapazierfähig, langlebig und darüber hinaus zu 100% recycelbar. Neben dem klassischen Glanz-Finish bieten wir bei ausgewählten Modellreihen auch einen matten Finish an.

Acciaio inox, opaco o lucido

In Svizzera, l'acciaio inox è tuttora la scelta preferenziale per il lavello di una cucina. È un materiale resistente, duraturo e per di più riciclabile al 100%. Oltre alla classica finitura lucida, per selezionate linee di modelli offriamo anche una finitura opaca.



Cristalite Plus® – Die Quarzkomposit-Spüle

Schock Spülen bestehen überwiegend aus Quarz. Die Oberflächen wurden speziell für die Anforderungen in der Küche entwickelt. Alltagsbelastungen gehen nahezu spurlos an den bewährten Materialtechnologien vorüber.

Cristalite Plus® –

il lavello con l'innovativo composito al quarzo

I lavelli Schock sono realizzati principalmente in quarzo e le superfici sono state progettate per le esigenze della cucina moderna. Le collaudate tecnologie dei materiali resistono all'usura quotidiana senza lasciare praticamente traccia.



Cristadur® – Die seidig matte Premium-Oberfläche

Die Premium-Materialität besteht durch eine patentierte, extrem feine Materialstruktur und eine anmutig schimmernde Oberfläche, an der Schmutz und Wasser einfach abperlen. Nicht nur der Look, sondern auch die Reinigungs-freundlichkeit sind also ein Komfort, der jeder Küche gut steht.

Cristadur® – la superficie premium opaca e fine

Questo materiale di elevata qualità si distingue per la sua struttura brevettata ed estremamente fine: una superficie splendente, dove sporco e acqua scivolano via facilmente. Non solo l'aspetto, ma anche la facilità di pulizia sono un comfort che fa bella mostra di sé in ogni cucina.

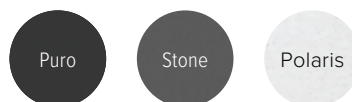

Carbon

Carbon begeistert als Material für Spülen aus Carbon-Quarzkomposit-Verbundwerkstoff nicht nur mit einer einmaligen Optik, sondern auch mit höchster Stabilität und Festigkeit bei maximaler Leichtigkeit, hoher Dauertemperaturbeständigkeit und einer korrosionsfreien und schlag-resistenten Oberfläche.

Carbonio

Il carbonio si distingue come materiale per lavelli in un composto stabile al carbonio-quarzo non solo per il suo aspetto unico, ma anche per la grande stabilità e resistenza con un peso ridotto, per l'elevata resistenza permanente alla temperatura e per una superficie resistente alla corrosione e agli urti.



Einbauarten

Tipi di installazione



Dezent und stufenlos

Einbau: von unten.

Die Becken werden stufenlos unterhalb der Arbeitsplatte montiert. Unterbau-Modelle wirken harmonisch und stellen die Arbeitsplatte ins Rampenlicht.

Discreto e senza sbalzi

Montaggio: sottopiano.

I lavelli vengono montati senza sbalzi al di sotto del piano di lavoro. I modelli sottopiano hanno un aspetto armonioso e mettono in risalto il piano di lavoro.



Materialübergang als Designelement

Einbau: flach aufliegend / flächenbündig.

Bei diesen Einbauvarianten ist der Rand des Beckens oder der Spüle der Star. Je nach Modell variieren die Randbreiten von 7–22 mm.

Die IF-Modelle können flach auf der Arbeitsplatte aufliegen oder bündig darin eingesetzt werden.

La transizione dei materiali come elemento di design

Montaggio: soprapiano / a filo top.

Con questo tipo di montaggio, il bordo del lavello diventa il protagonista. Le larghezze bordo variano da 7 a 22 mm, a seconda del modello. I modelli IF possono essere installati in piano oppure a filo top.

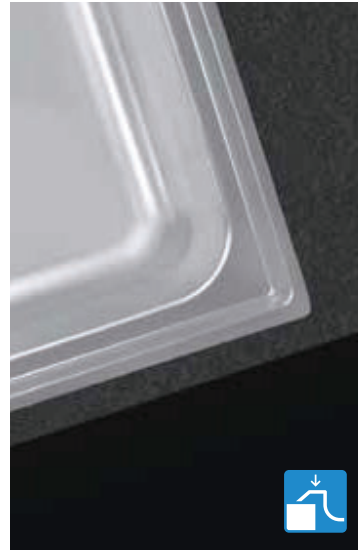

Klassisch zeitlos

Einbau: von oben.

Die Spüle wird von oben in den Ausschnitt eingefügt und liegt auf der Arbeitsplatte auf. Einlege-Spülen erleben dank neuen Designs und Funktionalitäten ein Comeback.

Un classico senza tempo

Montaggio: da incasso.

Il lavello viene semplicemente inserito dall'alto in un'apertura nel piano di lavoro. Grazie a nuove idee stilistiche e funzioni, i lavelli da incasso stanno vivendo una rinascita.



Nahtlos für höchste Ansprüche

Einbau: flächenbündig eingeschweisst.

Verbunden mit Ihrer Arbeitsplatte aus Edelstahl können wir Ihr Becken nach Wunsch direkt verarbeiten. Flächenbündig eingeschweisst aus einer Hand bleibt nachhaltig hygienisch und reinigungsfreundlich.

Agilità per le più elevate esigenze

Montaggio: a filo top termosaldato.

In combinazione con il piano di lavoro in acciaio inox, siamo in grado di lavorare il lavello come richiesto. La superficie a filo top termosaldata da un'unica fonte è igienica a lungo termine e facile da pulire.

Radien

Ein enger Radius von z.B. 12 mm betont die geradlinige, zeitlose Formensprache der Spüle. Je grösser der Radius, je einfacher auch die Reinigung. Wir bieten neun verschiedene Radien zur Auswahl, von 0 bis 117 mm.

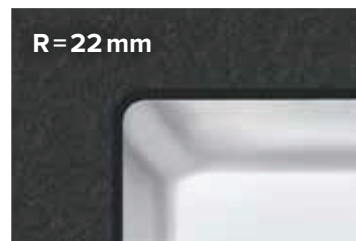
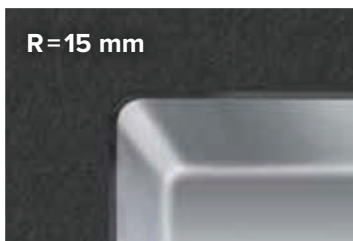

Raggi

Un raggio stretto mette in risalto la forma espressiva, lineare e senza tempo del lavello. Quanto più grande è il raggio, tanto più facile è la pulizia. Proponiamo una scelta di diversi raggi da 0 a 117 mm.

Elegante und funktionelle Ablauf- und Überlauftechnik

Una tecnologia di troppopieno e scarico elegante e funzionale



Desino: Verdeckter Ablauf mit untenliegendem Sieb

Der verdeckte Ablauf mit untenliegendem Sieb überzeugt durch sein modernes und funktionales Design. Speisereste werden nicht sichtbar gesammelt, was die Reinigung vereinfacht. Der Desino verfügt über drei verschiedene Positionen: offen, geschlossen und Reinigung, der Gebrauch im täglichen Kücheneinsatz wird dadurch enorm vereinfacht. Es stehen drei Bedienvarianten zur Verfügung: klassisch per Zugknopf, mit Touch-Flow und mit eFlow.

Desino: scarico coperto con griglietta inferiore

Lo scarico coperto con griglietta inferiore si distingue per il suo design moderno e funzionale. I residui alimentari raccolti non si vedono, il che semplifica la pulizia. Desino ha tre diverse posizioni: aperto, chiuso e pulizia, cosa che ne semplifica enormemente l'uso quotidiano in cucina. Sono disponibili tre varianti di comando: classica tramite pomolo, con TouchFlow e con il nuovissimo eFlow.



Erleben Sie Desino in Aktion
Scoprite Desino in azione.



Obenliegendes Sieb

Der elegante Siebeinsatz überzeugt mit ansprechendem Design und ist gleichzeitig praktisch in der Entnahme. Er bildet einen fast nahtlosen Übergang zum Beckenboden, was nicht nur optisch edel wirkt, sondern auch eine einfache Reinigung ermöglicht.

Griglietta superiore

L'elegante griglietta presenta un design accattivante e al contempo è pratica da rimuovere. Si posiziona praticamente a filo con il fondo del lavello, con un piacevole effetto visivo, ma consente anche un'agevole pulizia.



Tipo-Ventil

Das obenliegende Sieb und der Stopfen bilden bei diesem Ventil eine Einheit. Durch einen sanften Druck auf den Knopf in der Mitte des Siebs wird das Ablaufventil geschlossen und durch ein leichtes Ziehen wieder geöffnet.

Piletta Tipo

In questo sistema di piletta, la griglietta superiore e il tappo formano un'unica unità. Una leggera pressione sul pulsante nel mezzo della griglietta e una lieve trazione consentono rispettivamente di chiudere e riaprire la piletta di scarico.



Raumsparspar-Ventil

Öffnen und Schliessen des Ablaufventils erfolgt über den Zug-, Druck- oder Drehknopf. Standardmässig ist eine Ausführung des Zugknopfs im Lieferumfang enthalten. Auf Wunsch kann dieser individuell passend zur Armatur und zum Dispenser ausgesucht werden.

Piletta salvaspazio

L'apertura e la chiusura della piletta di scarico avvengono tramite il pomolo, il pulsante o la manopola. Nel corredo di fornitura è incluso uno dei modelli di pomolo disponibili. Su richiesta, questo può essere selezionato individualmente in base alla rubinetteria e al dispenser.



Verdeckter Überlauf mit schwenkbare Überlaufkappe

Die weiterentwickelte Version des verdeckten Überlaufs verfügt über eine schwenkbare Überlaufkappe. Erreicht das gestaute Wasser den Überlauf, schwenkt diese durch den Wasserdruck automatisch nach hinten und lässt das Wasser ungehindert abfließen. Die Überlaufkappe kann dank der magnetischen Halterung zur Reinigung einfach entfernt und wieder angebracht werden.

Troppopieno coperto con placchetta a ribalta

La versione perfezionata del troppopieno coperto dispone di una placchetta a ribalta. Quando l'acqua accumulata nel lavello raggiunge il livello di troppopieno, la placchetta ruota all'indietro per effetto della pressione esercitata dall'acqua, lasciandola libera di defluire. Il supporto magnetico consente di rimuovere e riposizionare facilmente la placchetta per le operazioni di pulizia.



Verdeckter Überlauf

Ein echtes Plus an Sauberkeit und Hygiene bietet der verdeckte Überlauf. Die Überlaufprägung ist ohne störende Fugen und Kanten direkt in die Beckenwand integriert. Das erlaubt eine besonders einfache Reinigung. In Kombination mit dem Raumspar- oder dem Tipo-Ventil verfügt die Überlaufkappe zudem über eine praktische magnetische Halterung (ausgenommen Silver Star Varix) und lässt sich dadurch bei Bedarf sekundenschnell entfernen oder wieder anbringen.

Troppopieno coperto

Pulizia e igiene sono i reali vantaggi offerti dal troppopieno coperto. L'impronta prestampata è direttamente integrata nella parete del lavello, senza fastidiosi giunti e spigoli. Una soluzione che rende estremamente semplice la pulizia. In combinazione con le pilette salvaspazio o Tipo, il tappo per troppopieno dispone inoltre di un pratico supporto magnetico (ad eccezione di Silver Star Varix) che ne permette, se necessario, la rimozione e il riposizionamento nel giro di pochi secondi.



¹Bei Stromausfall öffnet sich das Ventil automatisch.
In caso di interruzione dell'alimentazione, la piletta si apre automaticamente.

eFlow mit eControl

Die neu entwickelte, innovative Bedienvariante eFlow integriert sich fugenlos in die Beckenwand. Die drei Positionen offen, geschlossen und Reinigung lassen sich über die eControl einstellen. Der Ablauf des Wassers wird durch die eControl-Sensorbedieneinheit gesteuert. Direkt in die eControl eingebaute Sensoren überwachen zudem den Wasserfüllstand, überschreitet das gestaute Wasser eine definierte Höhe, wird das Ablaufventil automatisch geöffnet¹. Hat sich der Wasserstand gesenkt, wird das Ventil wieder geschlossen. Das Becken benötigt daher keinen physischen Überlauf mehr – ein absolutes Plus beim Thema Hygiene und eine grosse Erleichterung bei der Reinigung.

eFlow con eControl

L'innovativa variante di comando eFlow di recente sviluppo s'integra senza giunzioni nella parete del lavello. Le tre posizioni di apertura, chiusura e pulizia possono essere impostate tramite l'eControl. Lo scarico dell'acqua è controllato dall'unità di comando del sensore eControl. I sensori integrati direttamente nell'eControl monitorano inoltre il livello dell'acqua: in caso di superamento di un determinato livello dell'acqua di ristagno, attivano l'apertura automatica della piletta di scarico¹. Se invece il livello dell'acqua si riduce, la piletta si richiude nuovamente. Il lavello non ha quindi più bisogno di un troppopieno fisico: un vantaggio assoluto in termini d'igiene e un grande sollievo durante la pulizia.



TouchFlow-Ventil mit schwenkbare Überlaufkappe

Der verdeckte Überlauf wird gleichzeitig als Ventilsteuerung genutzt. Mit leichtem Druck auf die Überlaufkappe schliesst oder öffnet sich das elektronische Ablaufventil automatisch¹. Dieses Ventil ist bei ausgewählten Modellen in Kombination mit der neuen schwenkbaren Überlaufkappe erhältlich.

Piletta TouchFlow con placchetta a ribalta

Premendo leggermente sull'elemento in rilievo del troppopieno, un dispositivo di comando elettronico aziona la chiusura o apertura automatica¹ della piletta di scarico, che è disponibile in modelli selezionati in combinazione con la nuova placchetta di troppopieno a ribalta.

Ihre Wunschkombination

La vostra combinazione preferita

	Bedienung / Azionamento			Ausstattung / Dotazioni		
	TouchFlow-Ventil Piletta TouchFlow	Raumspars-Ventil Piletta salvaspazio	Tipo-Ventil Piletta Tipo	eFlow mit eControl eFlow con eControl	Schwenkbare Überlaufkappe Troppopieno con placchetta a ribalta	Verdeckter Überlauf Troppopieno coperto
Desino: Verdeckter Ablauf mit untenliegendem Sieb Desino: scarico coperto con griglietta inferiore 	✓	✓		✓	✓	
Obenliegendes Sieb Griglietta superiore 	✓	✓	✓		✓	✓

Varianten beschichtete Ventilbestandteile

Variante per componenti piletta rivestiti



Desino, schwarz matt

Desino, nero opaco



Desino, graphit

Desino, grafite



Überlaufkappe, schwarz matt

Placchetta di troppopieno, nero opaco



Überlaufkappe, graphit

Placchetta di troppopieno, grafite



PVD-Beschichtung, Graphit

Rivestimento a PVD, grafite



PVD-Beschichtung, Graphit

Rivestimento a PVD, grafite



PVD-Beschichtung, Graphit

Rivestimento a PVD, grafite



DEC-Beschichtung, schwarz matt

Rivestimento a DEC, nero opaco



DEC-Beschichtung, schwarz matt

Rivestimento a DEC, nero opaco



DEC-Beschichtung, schwarz matt

Rivestimento a DEC, nero opaco





Unsere Oberflächen	
Le nostre finiture	32
sTec-Beschichtung	
Rivestimento sTec	37
Oberflächen im Vergleich	
Superfici a confronto	38
Erdung und Masstoleranzen	
Superfici a confronto	40
Serviceleistungen Massanfertigungen	
Servizi soluzioni a misura	41
Massanfertigungs-Formen	
Forme delle soluzioni su misura	42
Randausführungen	
Bordature	52
Beckeneinbau	
Montaggio ad incasso di lavelli	71
Flächenbündig eingeschweisste Becken	
Lavelli termosaldati a filo top	72
Spüleneinpressungen nach Unterschrankmassen	
Lavelli prestampati per dimensioni di base	74
Flächenbündig eingeschweisste Becken	
Lavelli termosaldato	76
Spüleneinpressungen	
Lavelli prestampati	98
Manufaktur Tropfteile	
Manifattura di scolatoi	119
Kochfelder	
Piani cottura	122
Rückwände und Seitenwände	
Schienali e fianchi	125
Tablare, Fronten und Sockelblenden	
Ripiani, frontali e zoccolature	127
Ausschnitte, Schrägen und Rundungen	
Intagli, tagli inclinati e curvature	130
Verbindung von mehrteiligen Oberflächen	
Giunzione di superfici composte da più parti	133

Standardoberflächen / Superfici standard

Edelstahl hat viele Gesichter. Der Oberflächenfinish bestimmt zusammen mit der Schliiff- und Bürstrichtung den optischen Gesamteindruck des edlen Materials. Zur Wahl stehen 4 Standardoberflächen: Seidenmatt-Finish, Wirbel-Finish, Breitband-Finish oder Breitband Varix. Jede Oberfläche inszeniert die wertvolle Struktur des Werkstoffes anders und entlockt ihm dadurch unterschiedliche Spiegelungseigenschaften.

L'acciaio inox è un materiale pregiato che può assumere una grande varietà di apparenze, con un effetto estetico generale che è determinato dalla sua finitura superficiale e dal senso di lucidatura e di spazzolatura. Le superfici standard sono disponibili in 4 finiture: satinata, a turbino, a nastro largo o nastro largo Varix. Ognuna di esse pone diversamente in risalto la pregevole struttura del materiale, traendone una diversità di riflessi.

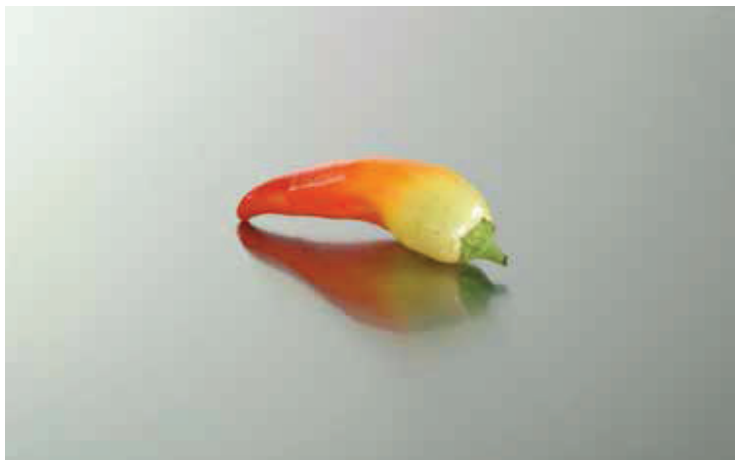

Seidenmatt-Finish

Die in Handarbeit gebürstete Oberfläche erhält durch diese aufwändige Bearbeitung ihren unvergleichlichen und edlen Glanz. Sie bietet zudem die grösste Reflexionskraft aller Standardoberflächen und fügt sich hervorragend in jede Umgebung ein.

Finitura satinata

Il piano di lavoro in acciaio inox viene spazzolato manualmente mediante un laborioso trattamento superficiale che gli conferisce la sua incomparabile brillantezza ed eleganza. Tra tutte le superfici standard, è quella che offre la massima riflettanza e la perfetta integrazione in qualsiasi ambiente.



Wirbel-Finish

Die von Hand mit dem Wirbelschleifer bearbeitete Oberfläche erhält durch die Wirbelung eine gleichmässige und sanfte Optik. Unter den Standardoberflächen wirkt diese am mattesten.

Finitura a turbino

La lavorazione manuale di questa superficie con la levigatrice a vortice le conferisce una fisionomia regolare e delicata. Tra tutte le superfici standard è quella che esprime la massima opacità.



Breitband-Finish

Wie der Name bereits verrät, wird diese Oberfläche mit einem breiten Band geschliffen und erhält so die charakteristische geradlinige und regelmässige Feinschliffstruktur. Sie wirkt etwas matter im Vergleich zum Seidenmatt-Finish.

Finitura a nastro largo

Come già il suo nome rivela, questa superficie viene lucidata con un nastro a banda larga che le dona la sua caratteristica struttura a linee sottili e regolari. Rispetto alla satinatura, essa produce un effetto di maggiore opacità.



Breitband Varix

Eine Variation des Breitband-Finish ist Breitband Varix. Der Schleiffaden ist etwas kürzer und vermittelt damit eine intensivere Optik.

Varix a nastro largo

Una variante della finitura a nastro largo è Varix a nastro largo. Il filo abrasivo è leggermente più corto e crea quindi un aspetto più intenso.

Decor Oberflächen / Superfici decor

Mit unseren strukturgewalzten Decor Oberflächen zeigen Sie Persönlichkeit und geben Ihrer Küche ein ganz neues Gesicht. Erhältlich in unterschiedlichen Strukturvarianten, begeistern die Arbeitsplatten mit ihrer edlen Optik, die hervorragend in modern eingerichtete Küchenkonzepte passt.

Le nostre superfici Decor lavorate con rullo strutturato conferiscono alla vostra cucina un carattere a se stante. Disponibili in diverse varianti strutturali, esse affascinano per la loro pregevole estetica che si armonizza magnificamente con i moderni progetti di cucina.



Polaris Silver

Die Oberfläche Polaris besticht durch ihre unverwechselbare Struktur und bringt neue Impulse bei der Küchengestaltung. In der Ausführung Silver bietet die Oberfläche nahezu unbegrenzte Kombinationsmöglichkeiten.

Polaris Silver

La superficie Polaris seduce per la sua inconfondibile struttura che stimola la creatività nella configurazione della cucina. Nella versione Silver essa offre una combinabilità quasi illimitata.

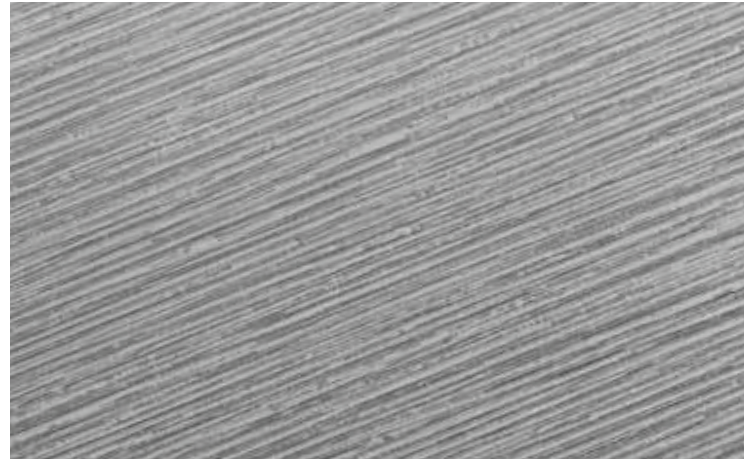

Polaris Black

Die schwarze Ausführung verleiht der Polaris Struktur noch mehr Ausdruck. Moderne und gleichzeitig zeitlose Küchenvariationen lassen sich mit dieser Oberfläche realisieren.

Polaris Black

La versione in nero rende la struttura Polaris ancor più incisiva ed espressiva, consentendo di realizzare varianti di cucina moderne e allo stesso tempo sempre attuali.



Terra

Die Oberfläche Terra präsentiert sich mit einer feinen, leicht körnigen Struktur, welche der Oberfläche eine sanfte und matte Optik verleiht. Diese fügt sich nahtlos in die Küchenumgebung ein und ist gleichzeitig ein garantierter Blickfang.

Terra

La superficie Terra si presenta con una struttura fine e leggermente granulosa che le conferisce una delicata opacità. Al suo fluido inserimento nell'ambiente cucina si associa la garanzia di una forte attrattiva.

Spezialoberflächen / Superfici speciali

Hochwertig und einzigartig in ihrer Erscheinung. Für höchste Ansprüche an Design und Verarbeitung von Edelstahl bieten unsere Spezialoberflächen mit ausgewählten Strukturen und Materialstärken ein ganz besonderes Highlight für Ihre Küche.

Espressioni di gran pregio e di unicità, le nostre superfici speciali offrono strutture e spessori di materiale selezionati che ben si conciliano con i rigorosi requisiti stilistici e di lavorazione dell'acciaio inox, concepiti per creare distinzione nella vostra cucina.



IceDesign™

Unsere Premiumoberfläche IceDesign™ ist in jeder Hinsicht ein echtes Unikat. Sowohl die individuelle Oberflächenstruktur des warmgewalzten Edelstahls als auch der Glanzgrad der hartverchromten Oberfläche lassen sich nicht standardisieren.

IceDesign™

La nostra superficie di alta gamma IceDesign™ rappresenta una creazione davvero unica. La particolare struttura superficiale dell'acciaio inox laminato a caldo e il grado di brillantezza della superficie con cromatura dura non sono standardizzabili.



BlackRange Industrial

Der industrielle Look dieser Spezialoberfläche macht die Arbeitsplatte zum Blickfang. Unregelmässigkeiten in Farbe und Struktur machen jedes Stück einzigartig. Mittels aufwändiger Bearbeitung der Oberfläche in Handarbeit wird die schwarze Zunderschicht soweit abgeschliffen, bis ein spannender Kontrast zwischen Schwarz- und Silberanteil entsteht.

BlackRange Industrial

Il look industriale di questa superficie speciale trasforma il piano di lavoro in un'autentica attrazione, le cui irregolarità cromatiche e strutturali rendono ogni manufatto unico nel suo genere. Attraverso una minuziosa lavorazione manuale della superficie, lo strato di scaglia color nero viene molato fino a creare un seducente contrasto tra la colorazione nera e quella argentea.

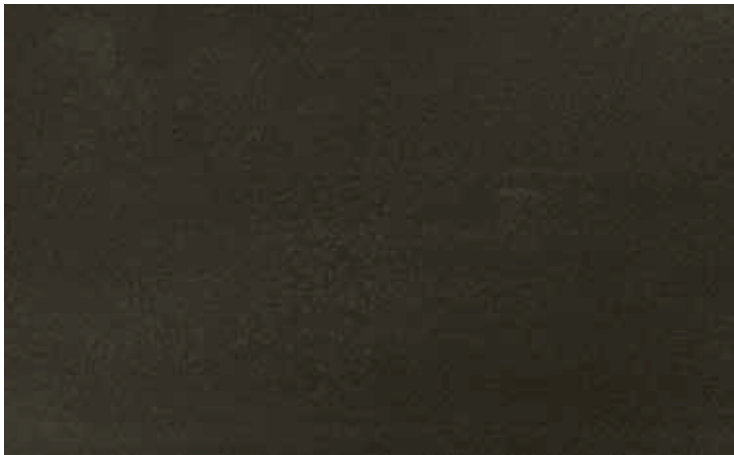

BlackRange Passion

Die ästhetische Magie dieser schwarzen, individuell strukturierten Edelstahloberfläche ist unerreichbar. Unregelmässigkeiten sowie Farb- und Strukturunterschiede gehören auch bei BlackRange Passion zum Produktkonzept, sind aber weniger stark ausgeprägt als bei BlackRange Industrial. Zudem verfügt sie über einen höheren Schwarzanteil.

BlackRange Passion

La magia estetica di questa superficie nera e particolarmente strutturata in acciaio è ineguagliabile. Piccole irregolarità, differenze cromatiche e strutturali della superficie BlackRange Passion rientrano anch'esse nel concetto progettuale di questo prodotto, ma sono meno pronunciate rispetto a BlackRange Industrial. Inoltre, questa superficie è caratterizzata da un maggior tenore di nero.

Individuelle Bemusterung für IceDesign™ und BlackRange

Unsere Premiumoberflächen IceDesign™ und BlackRange sind in jeder Hinsicht echte Unikate. Aufgrund dieser Einzigartigkeit bieten wir die Möglichkeit, diese Oberflächen persönlich vor der Verarbeitung in unserer Edelstahl-Manufaktur auszusuchen.

Kontaktieren Sie uns, um einen Termin zu vereinbaren.

T + 41 58 263 64 00, bemusterung@suter.ch

Campionatura individuale per IceDesign™ e BlackRange

Le nostre superfici di alta gamma IceDesign™ e BlackRange sono dei pezzi unici sotto ogni aspetto. Data la loro unicità, offriamo la possibilità di scegliere queste superfici di persona prima della lavorazione presso la nostra manifattura di acciaio inox.

Contattateci per fissare un appuntamento.

T + 41 58 263 64 00, bemusterung@suter.ch



Polar Look

Für diese Oberfläche wird der warmgewalzte Edelstahl mittels eines metallurgischen Materialabtragsverfahrens (Elektropolitur) bearbeitet. Das Ergebnis ist eine extravagante Edelstahl-Arbeitsplatte.

Polar Look

La superficie in acciaio inox laminato a caldo viene lavorata con un metodo metallurgico di asportazione del materiale (pulitura elettrolitica). Ne risulta un piano di lavoro in acciaio inox dall'effetto insolito.



Xrange Ice

Das aussergewöhnliche Hauptmerkmal dieser Oberfläche ist eine im Kreuz geschliffene Struktur, welche nicht nur in ihrer Erscheinung, sondern auch in ihrer Haptik aussergewöhnlich ist. In dieser Ausführung wird der Kreuzschliff durch den Glanz der hartverchromten Oberfläche besonders zur Geltung gebracht.

Xrange Ice

La struttura rettificata a croce di questa superficie è ciò che la rende straordinaria non solo esteticamente, ma anche per la percezione aptica che essa induce. In questa versione la rettifica a croce è valorizzata dalla brillantezza della superficie rivestita in cromo duro.



Xrange Finline

Die Ausführung Finline weist dieselben Struktureigenschaften auf wie Xrange Ice. Einziger Unterschied ist der Glanzgrad aufgrund der natürlich belassenen Edelstahloberfläche. Xrange Finline zeigt sich deshalb mit einem vergleichsweise warmen Farbton und einem matteren Erscheinungsbild gegenüber der Oberfläche Xrange Ice.

Xrange Finline

La versione Finline presenta le medesime proprietà strutturali della superficie Xrange Ice. L'unica differenza risiede nel grado di brillantezza della superficie in acciaio inox lasciato allo stato naturale. Rispetto alla superficie Xrange Ice, la Xrange Finline si fa notare per la tonalità cromatica relativamente calda e la maggiore opacità.



Xrange Black

Der einzigartige Kreuzschliff des Xrange wirkt durch die Kombination der schwarzen Oberfläche mit charakteristisch silbern schimmernder Edelstahlstruktur noch eleganter und leichter. Die hervorragenden Eigenschaften unterstützen die spannende Optik, welche sich je nach Lichteinfall oder Betrachtungswinkel harmonisch in Ihr Küchenkonzept integriert.

Xrange Black

L'esclusiva rettifica a croce di Xrange è ancora più elegante e leggera, grazie alla combinazione della superficie nera con la caratteristica struttura in acciaio inox argentato. Le eccellenti caratteristiche supportano l'aspetto accattivante, che s'integra armoniosamente nel vostro progetto di cucina a seconda dell'incidenza della luce o dell'angolo di osservazione. cromatica relativamente calda e la maggiore opacità.

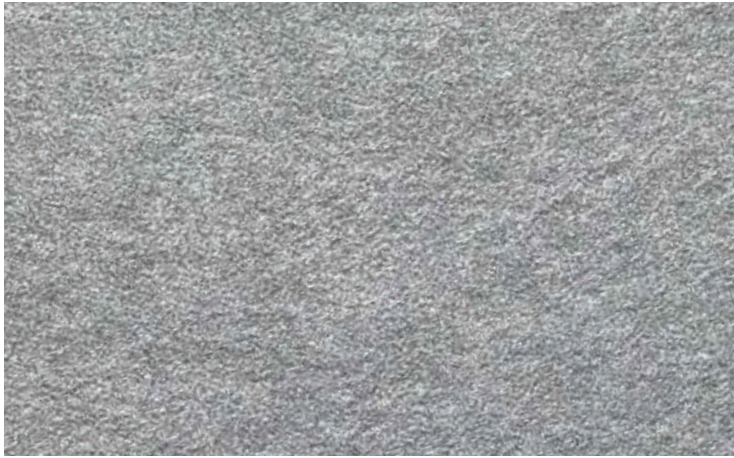

Silk Look

Die warmgewalzte und von Hand mit einem Wirbelschleifer bearbeitete Oberfläche zeigt sich in einer besonders matten und unregelmässigen Optik. Die individuelle Struktur des warmgewalzten Edelstahl bleibt als besondere Charakteristik dezent sichtbar.

Silk Look

Questa superficie laminata a caldo e lavorata manualmente con una levigatrice a vortice si presenta con una particolare finitura opaca e irregolare. Caratteristica strutturale dominante dell'acciaio inox laminato a caldo è la sua discreta visibilità.

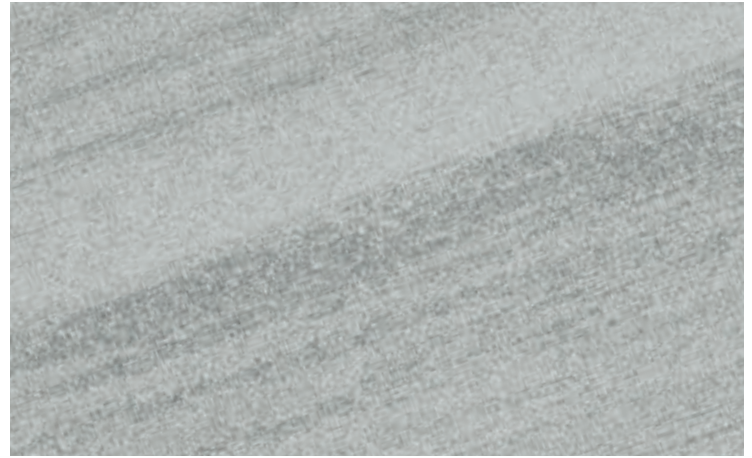

Warmgewalzt *

Die warmgewalzte Oberfläche zeichnet sich durch ihre matte und unregelmässige Struktur aus, welche einzigartig und rohmaterialbedingt ist. Jede Oberfläche ist somit ein Unikat und verleiht der Küche eine exklusive Note.

Laminazione a caldo

La superficie laminata a caldo si distingue per la sua struttura opaca e irregolare, determinata dalle esclusive proprietà del materiale grezzo. Ogni superficie è quindi un pezzo unico che alla cucina conferisce una nota di esclusività.

* **Warmgewalzter Edelstahl:** Kleine Unregelmässigkeiten, Farb- und Strukturunterschiede sind rohmaterialbedingt und Teil der Einzigartigkeit der Massanfertigungen.

* **Acciaio inox laminato a caldo:** Piccole irregolarità, differenze cromatiche e strutturali sono dovute alle caratteristiche della materia prima e sono parte dell'unicità delle realizzazioni su misura.

sTec-Beschichtung / Rivestimento sTec

Fingerabdrücke haben keine Chance / Le impronte digitali non hanno scampo

sTec ist eine hochwertige Easy-to-Clean- und Antifingerprint-Beschichtung für Edelstahl-Oberflächen. Dabei wird eine farblose und transparente Beschichtung auf den Edelstahl aufgetragen. Die Beschichtung ist UV-beständig, lebensmittelecht sowie visuell und haptisch unauffällig. Sie wirkt wasser- und schmutzabweisend und sorgt so für ein hervorragendes Reinigungsverhalten. Flüssigkeiten perlen ab und Fingerabdrücke haben keine Chance.

sTec è un rivestimento molto pregiato Easy-to-Clean e Antifingerprint per superfici in acciaio inox che comporta l'applicazione superficiale di una patina incolore e trasparente. Questo rivestimento è resistente all'ultravioletto, idoneo all'uso alimentare e quasi impercettibile all'occhio e al tatto. Svolge un'azione idrorepellente e antisporco, assicurando quindi un'eccezionale facilità di pulitura. Inoltre, è a prova di liquidi e di impronte digitali.



Erhältlich ist die sTec-Beschichtung für die nachstehenden Oberflächen: Il rivestimento sTec è disponibile per le seguenti superfici speciali:

Wirbel-Finish



Xrange Finline



Xrange Black (nur mit sTec / solo con sTec)

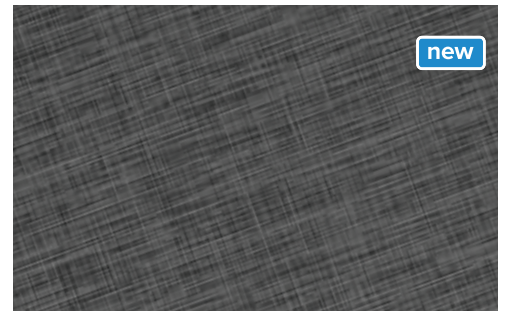

Silk Look



Warmgewalzt / Laminazione a caldo



Oberflächen im Vergleich / Superfici a confronto

Standardoberflächen / Superfici standard

Oberflächen Superfici	sTec	Erhältliche Kantenhöhen Altezze di bordi disponibili		Max. Abmessungen ¹ (in mm) Dimensioni max. ¹ (in mm)		L- oder U-Winkel Angolo a «L» o a «U»	
		SmartSteel Collection	SolidSteel Collection	SmartSteel Collection	SolidSteel Collection	Einteilig ² Intera ²	Mehrteilig ³ In più parti ³
Seidenmatt-Finish Finitura satinata	SF	–	–	6000 × 1750	–	✓	✓
Breitband-Finish Finitura a nastro largo	BF	–	–	6000 × 1750	–	✓	✓
		–	4/5/8 mm	–	3980 × 1980 × 4 4980 × 1980 × 5/8	–	✓
Breitband Varix Nastro largo Varix	BX	–	–	3900 × 1400	–	–	✓
Wirbel-Finish Finitura a turbino	WF	–	–	6000 × 1750	–	✓	✓
		–	4/5/8 mm	–	3980 × 1980 × 4 4980 × 1980 × 5/8	–	✓
		✓	4/5/8 mm	–	3980 × 1480	–	✓

Decor Oberflächen / Superfici Decor

Oberflächen Superfici	sTec	Erhältliche Kantenhöhen Altezze di bordi disponibili		Max. Abmessungen ¹ (in mm) Dimensioni max. ¹ (in mm)		L- oder U-Winkel Angolo a «L» o a «U»	
		SmartSteel Collection	SolidSteel Collection	SmartSteel Collection	SolidSteel Collection	Einteilig ² Intera ²	Mehrteilig ³ In più parti ³
Polaris Silver	PS	–	–	3900 × 1400	–	–	✓
Polaris Black	PB	–	–	3900 × 1400	–	–	✓
Terra	TR	–	–	3900 × 1400	–	–	✓

Spezialoberflächen / Superfici speciali

Oberflächen Superfici	sTec	Erhältliche Kantenhöhen Altezze di bordi disponibili		Max. Abmessungen ¹ (in mm) Dimensioni max. ¹ (in mm)		L- oder U-Winkel Angolo a «L» o a «U»	
		SmartSteel Collection ⁴	SolidSteel Collection	SmartSteel Collection	SolidSteel Collection	Einteilig ² Intera ²	Mehrteilig ³ In più parti ³
IceDesign™	ID	–	4/8 mm	–	3950 × 1450 × 4 4950 × 1450 × 8	–	✓
BlackRange Industrial	BI	–	8 mm	–	3900 × 1400	–	✓
BlackRange Passion	BP	–	8 mm	–	3900 × 1400	–	✓
Polar Look	PL	–	4/8 mm	–	3950 × 1450 × 4 4950 × 1450 × 8	–	✓
Xrange Ice	XI	–	5 mm	–	3900 × 1450	–	✓
Xrange Finline	XF	✓	5 mm	–	3900 × 1480	–	✓
Xrange Black*	XB	✓	5 mm	–	3900 × 1480	–	✓
Silk Look	SL	✓	4/8 mm	–	3950 × 1450 × 4 4950 × 1450 × 8	–	✓
Warmgewalzt Laminazione a caldo	WG	✓	4/8 mm	–	3950 × 1450 × 4 4950 × 1450 × 8	–	✓

* XB nur mit sTec / solo con sTec

sTec ist eine hochwertige Easy-to-Clean- und Antifingerprint-Beschichtung. Mehr Information auf Seite 37.
sTec è un rivestimento molto pregiato Easy-to-Clean e Antifingerprint. Più informazioni sulla pag. 37.¹ Übergrößen auf Anfrage / Dimensioni speciali su richiesta² Einteilig / Intera:

- Mit Schweissnaht / Con giunto saldato

³ Mehrteilig / In più parti:- Standard- und Decor Oberflächen mit Stecknaht / Superfici standard e Decor con giunto ad innesto sovrapposto
- Spezialoberflächen mit Stoss- oder Steckverbindung / Superfici speciali con giunto di testa o ad innesto sovrapposto⁴ SmartSteel Collection:

- Kante geschliffen Standard (Bild 1, Seite 52) / Bordo rettificato standard (immagine 1, pagina 52)

Standardoberflächen / Superfici standard



Seidenmatt-Finish
Finitura satinata



Wirbel-Finish
Finitura a turbinio



Breitband-Finish
Finitura a nastro largo



Breitband Varix
Nastro largo Varix

Weitere Produktinformationen / Altre informazioni prodotto  32

Decor Oberflächen / Superfici decor



Polaris Silver

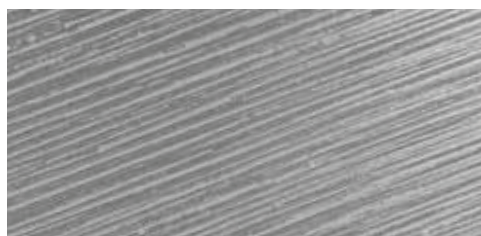

Polaris Black



Terra

Weitere Produktinformationen / Altre informazioni prodotto  33

Spezialoberflächen / Superfici speciali



IceDesign™

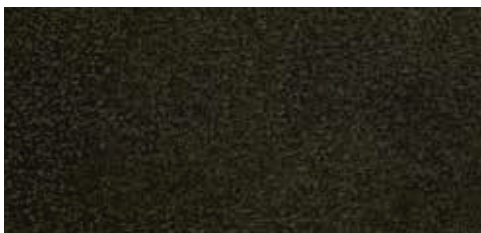

BlackRange Industrial

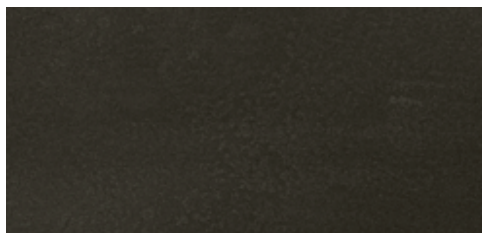

BlackRange Passion



Polar Look

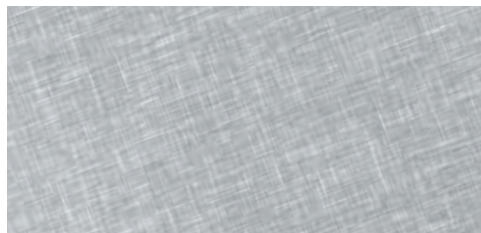

Xrange Ice

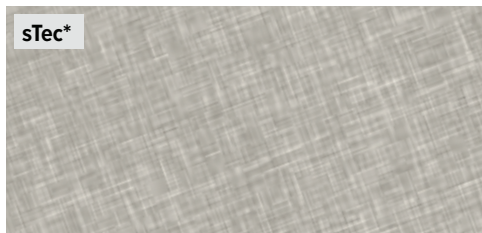

Xrange Finline

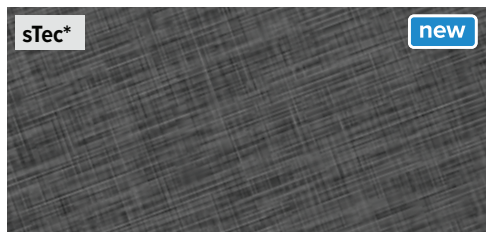

Xrange Black (nur mit sTec / solo con sTec)



Silk Look

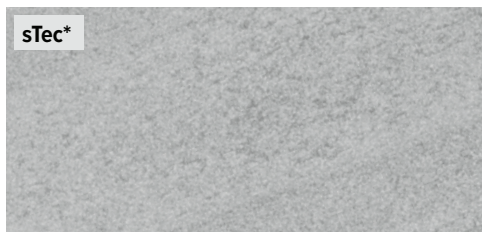

Warmgewalzt / Laminazione a caldo

Weitere Produktinformationen / Altre informazioni prodotto  34-36

* Diese Oberflächen sind mit sTec erhältlich. Mehr Informationen dazu auf Seite 37.

* Queste superfici sono disponibili con sTec. Ulteriori informazioni sono disponibili a pagina 37.

Positionierung der Erdungsfahne / Posizionamento capocorda di terra

Gültig für Bauteile ab einer Grösse von 1 m²
Valido per elementi strutturali con dimensioni a partire da 1 m²

Bauteil Elemento strutturale	Position Erdungsfahne ohne Komponenten Posizione capocorda di terra senza componenti	Position Erdungsfahne mit Komponenten Posizione capocorda di terra con componenti
Arbeitsplatte einteilig Piano di lavoro in più parti	Freie Positionierung ¹ Posizionamento libero ¹	1 Erdungsfahne wahlweise beim Becken, beim Kochfeld oder bei der Steckdose 1 capocorda di terra, a scelta presso il lavello, il piano di cottura o la presa
Arbeitsplatte mehrteilig Piano di lavoro in più parti	Freie Positionierung pro Arbeitsplatte ¹ Posizionamento libero per ogni piano di lavoro ¹	Pro Arbeitsplatte 1 Erdungsfahne wahlweise beim Becken, beim Kochfeld oder bei der Steckdose Capocorda di terra per ogni piano di lavoro, a scelta presso il lavello, il piano di cottura o la presa
Rückwand Pannello posteriore	Freie Positionierung pro Rückwand ¹ Posizionamento libero per ogni pannello posteriore ¹	Pro Rückwand bei der Steckdose (Bei mehreren Steckdosen ist eine Erdungsfahne pro Rückwand ausreichend) Presso la presa per ogni pannello posteriore (nel caso di più prese, è sufficiente un capocorda di terra per ogni pannello)

¹ Ohne Vorgaben wird die Positionierung der Erdungsfahne werkseitig bestimmt. /¹ In assenza di indicazioni, il posizionamento del capocorda di terra viene predefinito in fabbrica.



Erdungskabel an der gekennzeichneten Position montieren.
Montare il cavo di terra nella posizione contrassegnata.

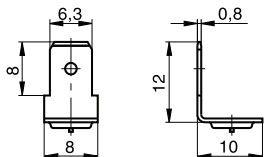

Erdungsfahne / Flachstecker L
Capocorda di terra / Connettore piatto L

Allgemeintoleranzen für Längen- und Winkelmasse Tolleranze generali per lunghezze e angoli

Nennmassbereich Gamma di dimensioni nominali	bis 1000 mm fino a 1000 mm	1001 – 2000 mm	2001 – 4000 mm	über 4000 mm oltre 4000 mm
Längenmasse Misure di lunghezza	±1	±2	±3	Tolleranzen bei Bestellung vermerken. Indicare le tolleranze in sede d'ordine.

i Grenzabmasse in mm für Nennmassbereiche.
Dimensioni limite in mm per gamma di dimensioni nominali.

Nennmassbereich Gamma di dimensioni nominali	über 400 mm oltre 400 mm
Winkelmasse / Misure d'angolo Rundungshalbmesser und Fasen / Raggi di curvatura e smussi	±0° 10'

i Grenzabmasse in mm für Nennmassbereiche.
Misure limite in mm per campo nominale di misura.

Serviceleistungen Edelstahl-Massanfertigungen / Servizi soluzioni a misura in acciaio inox



Direktlieferung auf die Baustelle

Gerade bei Abdeckungen mit Übergrößen oder Sondermassen ist ein termin- und fachgerechter Transport wichtig. Deshalb bieten wir Ihnen auf Wunsch eine direkte Lieferung auf die Baustelle an. Nebst dem Liefertermin können Sie ebenfalls ein Zeitfenster von zwei Stunden wählen¹.

Consegna diretta a piè d'opera

Soprattutto nel caso di coperture sovradimensionate o con misure speciali, è importante poter contare su puntualità e adeguatezza del trasporto. Su richiesta, saremo quindi lieti di offrirvi la consegna diretta a piè d'opera. Oltre al termine di consegna, è possibile selezionare una finestra temporale di due ore¹.

Kontakt für Terminvereinbarung: Contatto per fissare un termine di consegna:

Gerne liefern wir Ihnen Ihre Abdeckung von Montag bis Freitag. In einzelnen Gebieten und Randregionen sind Lieferungen erst ab 10:00 Uhr möglich. Gerne informieren wir Sie direkt bei der Terminvereinbarung über unsere Möglichkeiten.

Saremo lieti di consegnare la vostra copertura da lunedì a venerdì. In alcune zone e regioni periferiche le consegne sono possibili solo a partire dalle ore 10:00. Saremo lieti d'informarvi direttamente sulla nostra possibile disponibilità al momento di fissare il termine di consegna.

T +41 58 263 64 00
suter@suter.ch



Ausmess-Service

Sparen Sie Zeit und reduzieren Sie das Fehlerrisiko, indem Sie von unserem professionellen Ausmess-Service profitieren. Erfahrene Fachkräfte prüfen bauliche Voraussetzungen und erstellen exakte Skizzen für die Fertigung¹.

Servizio di misurazione

Usufruendo del nostro servizio professionale di misurazione, riducete il rischio di errori e risparmiate tempo prezioso. I nostri tecnici specializzati provvedono ad accertare i requisiti strutturali e ad eseguire precisi schizzi preliminari per la fabbricazione¹.

Kundendienst: / Servizio clienti:

T +41 58 263 64 80
kundendienst@suter.ch
servizioclienti@suter.ch



Montage-Service

Wir bringen die bestellte Edelstahl-Massanfertigung termingerecht auf die Baustelle und montieren sie professionell vor Ort. So kommen alle Arbeiten rund um den Edelstahl aus einer Hand und Sie profitieren von einem reibungslosen Ablauf¹.

Servizio di montaggio

Noi consegniamo con puntualità la soluzione su misura in acciaio inox da voi ordinata e provvediamo al suo montaggio direttamente sul posto con la massima professionalità. Tutto ciò che riguarda la messa in opera dell'acciaio inox viene così preso in carico da un unico interlocutore e portato a termine senza il minimo inconveniente¹.

Kundendienst: / Servizio clienti:

T +41 58 263 64 80
kundendienst@suter.ch
servizioclienti@suter.ch



Individuelle Bemusterung für IceDesign™ und BlackRange

Unsere Premiumoberflächen IceDesign™ und BlackRange sind in jeder Hinsicht echte Unikate. Aufgrund dieser Einzigartigkeit bieten wir die Möglichkeit, diese Oberflächen persönlich vor der Verarbeitung in unserer Edelstahl-Manufaktur auszusuchen.

Campionatura individuale per IceDesign™ e BlackRange

Le nostre superfici di alta gamma IceDesign™ e BlackRange sono dei pezzi unici sotto ogni aspetto. Data la loro unicità, offriamo la possibilità di scegliere queste superfici di persona prima della lavorazione presso la nostra manifattura di acciaio inox.

Zentrale: / Centralino:

T +41 58 263 64 00
bemusterung@suter.ch

¹Preis auf Anfrage.
¹Prezzo su richiesta.

Massanfertigungs-Formen / Forme delle soluzioni su misura

Einzeilig / Su una linea

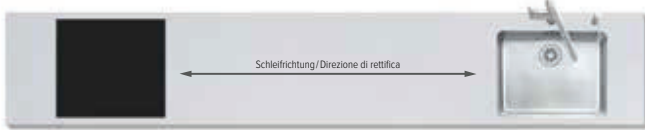

Erhältliche Ausführung / Lavorazione disponibile

SmartSteel Collection



SolidSteel Collection



Weitere Produktinformationen / Altre informazioni prodotto 

Erhältliche Oberflächen / Superfici disponibili

Standard

SF BF BX WF

Decor

PS PB TR

Spezial

ID BI BP PL XI XF XB SL WG

Weitere Produktinformationen / Altre informazioni prodotto 

Zweizeilig / Su due linee



Erhältliche Ausführung / Lavorazione disponibile

SmartSteel Collection



SolidSteel Collection



Weitere Produktinformationen / Altre informazioni prodotto 

Erhältliche Oberflächen / Superfici disponibili

Standard

SF BF BX WF

Decor

PS PB TR

Spezial

ID BI BP PL XI XF XB SL WG

Weitere Produktinformationen / Altre informazioni prodotto 

L-Winkel / A «L»



Erhältliche Ausführung / Lavorazione disponibile

SmartSteel Collection



SolidSteel Collection



Weitere Produktinformationen / Altre informazioni prodotto 

Erhältliche Oberflächen / Superfici disponibili

Standard

SF BF BX WF

Decor

PS PB TR

Spezial

ID BI BP PL XI XF XB SL WG

Weitere Produktinformationen / Altre informazioni prodotto 

Standardoberflächen / Superfici standard

SF	Seidenmatt-Finish / Finitura satinata
BF	Breitband-Finish / Finitura a nastro largo
BX	Breitband Varix / Nastro largo Varix
WF	Wirbel-Finish / Finitura a turbino

Decor Oberflächen / Superfici Decor

PS	Polaris Silver
PB	Polaris Black
TR	Terra

Spezialoberflächen / Superfici speciali

ID	IceDesign™	PL	Polar Look	XB	Xrange Black
BI	BlackRange Industrial	XI	Xrange Ice	SL	Silk Look
BP	BlackRange Passion	XF	Xrange Finline	WG	Warmgewalzt Laminazione a caldo

Alle Massangaben in mm
Unità di misura in mm

U-Winkel / A «U»



Erhältliche Ausführung / Lavorazione disponibile

SmartSteel Collection



SolidSteel Collection



Weitere Produktinformationen / Altre informazioni prodotto



Erhältliche Oberflächen / Superfici disponibili

Standard

SF BF BX WF

Decor

PS PB TR

Spezial

ID BI BP PL XI XF XB SL WG

Weitere Produktinformationen / Altre informazioni prodotto



Kochinsel / Isola di cottura

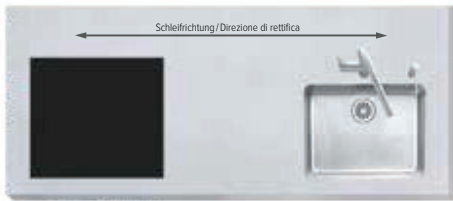

Erhältliche Ausführung / Lavorazione disponibile

SmartSteel Collection



SolidSteel Collection



Weitere Produktinformationen / Altre informazioni prodotto



Erhältliche Oberflächen / Superfici disponibili

Standard

SF BF BX WF

Decor

PS PB TR

Spezial

ID BI BP PL XI XF XB SL WG

Weitere Produktinformationen / Altre informazioni prodotto



Kochinsel mit Rundung / Isola di cottura



Erhältliche Ausführung / Lavorazione disponibile

SmartSteel Collection



SolidSteel Collection



Weitere Produktinformationen / Altre informazioni prodotto



Erhältliche Oberflächen / Superfici disponibili

Standard

SF BF WF

Spezial

ID BI BP PL XI XF XB SL WG

Weitere Produktinformationen / Altre informazioni prodotto



Standardoberflächen / Superfici standard

SF	Seidenmatt-Finish / Finitura satinata
BF	Breitband-Finish / Finitura a nastro largo
BX	Breitband Varix / Nastro largo Varix
WF	Wirbel-Finish / Finitura a turbino

Decor Oberflächen / Superfici Decor

PS	Polaris Silver
PB	Polaris Black
TR	Terra

Spezialoberflächen / Superfici speciali

ID	IceDesign™	PL	Polar Look	XB	Xrange Black
BI	BlackRange Industrial	XI	Xrange Ice	SL	Silk Look
BP	BlackRange Passion	XF	Xrange Finition	WG	Warmgewalzt Laminazione a caldo

Alle Massangaben in mm
Unità di misura in mm

L-Winkel mit Eckschräge 45° einfach / A «L» con taglio inclinato a 45° semplice



Erhältliche Ausführung / Lavorazione disponibile

SmartSteel Collection



SolidSteel Collection

Weitere Produktinformationen / Altre informazioni prodotto  38

Erhältliche Oberflächen / Superfici disponibili

Standard

SF BF BX WF

Decor

PS PB TR

Spezial

ID BI BP PL XI XF XB SL WG

Weitere Produktinformationen / Altre informazioni prodotto  32-36

L-Winkel mit Eckschräge 45° doppelt / A «L» con taglio inclinato a 45° doppio



Erhältliche Ausführung / Lavorazione disponibile

SmartSteel Collection



SolidSteel Collection

Weitere Produktinformationen / Altre informazioni prodotto  38

Erhältliche Oberflächen / Superfici disponibili

Standard

SF BF BX WF

Decor

PS PB TR

Spezial

ID BI BP PL XI XF XB SL WG

Weitere Produktinformationen / Altre informazioni prodotto  32-36

Offener U-Winkel / A «U» aperta



Erhältliche Ausführung / Lavorazione disponibile

SmartSteel Collection



SolidSteel Collection

Weitere Produktinformationen / Altre informazioni prodotto  38

Erhältliche Oberflächen / Superfici disponibili

Standard

SF BF BX WF

Decor

PS PB TR

Spezial

ID BI BP PL XI XF XB SL WG

Weitere Produktinformationen / Altre informazioni prodotto  32-36

Standardoberflächen / Superfici standard

SF	Seidenmatt-Finish / Finitura satinata
BF	Breitband-Finish / Finitura a nastro largo
BX	Breitband Varix / Nastro largo Varix
WF	Wirbel-Finish / Finitura a turbino

Decor Oberflächen / Superfici Decor

PS	Polaris Silver
PB	Polaris Black
TR	Terra

Spezialoberflächen / Superfici speciali

ID	IceDesign™	PL	Polar Look	XB	Xrange Black
BI	BlackRange Industrial	XI	Xrange Ice	SL	Silk Look
BP	BlackRange Passion	XF	Xrange Finline	WG	Warmgewalzt Laminazione a caldo

Alle Massangaben in mm
Unità di misura in mm

Offener L-Winkel mit tiefer gesetzter Arbeitsfläche / A «L» aperta, con piano di lavoro ribassato



Erhältliche Ausführung / Lavorazione disponibile

SmartSteel Collection



SolidSteel Collection



Weitere Produktinformationen / Altre informazioni prodotto 

Erhältliche Oberflächen / Superfici disponibili

Standard	SF	BF	BX	WF					
Decor	PS	PB	TR						
Spezial	ID	BI	BP	PL	XI	XF	XB	SL	WG

Weitere Produktinformationen / Altre informazioni prodotto 

Mehrteilig (Schulküche) / Composita (cucina per uso scolastico)



Erhältliche Ausführung / Lavorazione disponibile

SmartSteel Collection



SolidSteel Collection



Weitere Produktinformationen / Altre informazioni prodotto 

Erhältliche Oberflächen / Superfici disponibili

Standard	SF	BF	BX	WF					
Decor	PS	PB	TR						
Spezial	ID	BI	BP	PL	XI	XF	XB	SL	WG

Weitere Produktinformationen / Altre informazioni prodotto 

Standardoberflächen / Superfici standard

SF	Seidenmatt-Finish / Finitura satinata
BF	Breitband-Finish / Finitura a nastro largo
BX	Breitband Varix / Nastro largo Varix
WF	Wirbel-Finish / Finitura a turbino

Decor Oberflächen / Superfici Decor

PS	Polaris Silver
PB	Polaris Black
TR	Terra

Spezialoberflächen / Superfici speciali

ID	IceDesign™	PL	Polar Look	XB	Xrange Black
BI	BlackRange Industrial	XI	Xrange Ice	SL	Silk Look
BP	BlackRange Passion	XF	Xrange Finline	WG	Warmgewalzt Laminazione a caldo

Alle Massangaben in mm
Unità di misura in mm

Kochinsel einteilig seitwärts an den Boden gezogen / Isola di cottura in pezzo unico

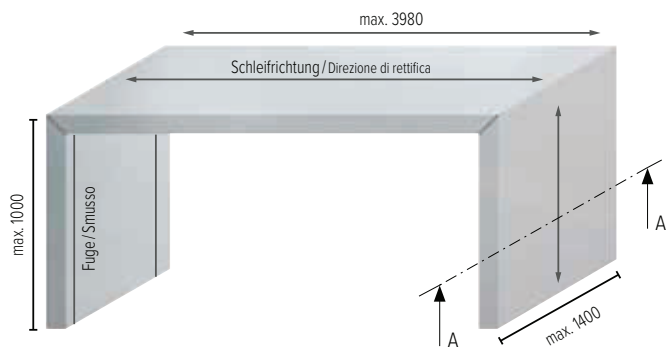

Schnitt A-A / Intaglio A-A

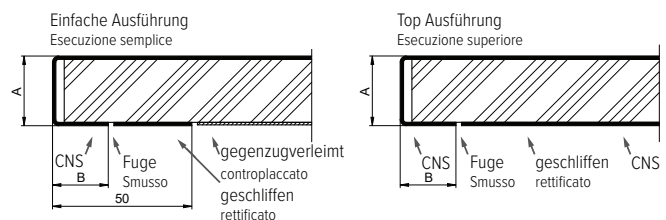

Erhältliche Ausführung / Lavorazione disponibile

SmartSteel Collection SolidSteel Collection

Weitere Produktinformationen / Altre informazioni prodotto  38

Erhältliche Oberflächen / Superfici disponibili

Standard SF BF WF

Weitere Produktinformationen / Altre informazioni prodotto  32

i Größere Abmessung und Quetschkante frontbündig auf Anfrage. Dimensioni speciali e bordo pressato a filo frontale su richiesta.

Abkantungen SmartSteel Collection mit Standardoberflächen
Piegature lamiera sottile con SmartSteel Collection

Erhältliche Kantenhöhe in mm (A)	12	15	20-100
Länge Abkantung in mm (B)	10	20	50

Kochinsel einteilig seitwärts an den Boden gezogen / Isola di cottura in pezzo unico

new

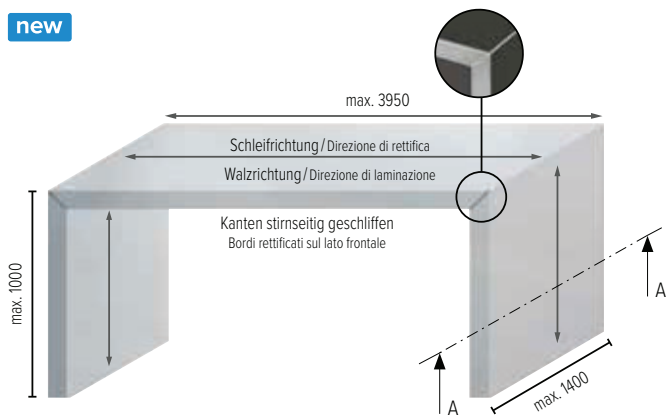

Schnitt A-A / Coupe A-A

Einfache Ausführung
Esecuzione semplice

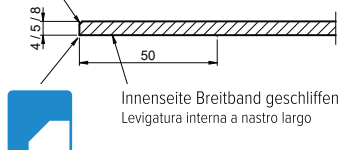

Innenseite Breitband geschliffen
Levigatura interna a nastro largo

Top Ausführung
Esecuzione qualità superiore

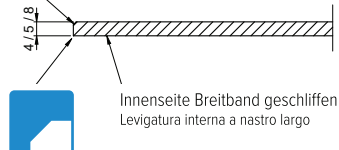

Innenseite Breitband geschliffen
Levigatura interna a nastro largo

Erhältliche Ausführung / Lavorazione disponibile

SmartSteel Collection SolidSteel Collection

Weitere Produktinformationen / Altre informazioni prodotto  38

Erhältliche Oberflächen / Superfici disponibili

Standard BF WF
Spezial ID BI BP PL XI XF XB SL WG

Weitere Produktinformationen / Altre informazioni prodotto  32+34

Standardoberflächen / Superfici standard

SF	Seidenmatt-Finish / Finitura satinata
BF	Breitband-Finish / Finitura a nastro largo
BX	Breitband Varix / Nastro largo Varix
WF	Wirbel-Finish / Finitura a turbino

Decor Oberflächen / Superfici Decor

PS	Polaris Silver
PB	Polaris Black
TR	Terra

Spezialoberflächen / Superfici speciali

ID	IceDesign™	PL	Polar Look	XB	Xrange Black
BI	BlackRange Industrial	XI	Xrange Ice	SL	Silk Look
BP	BlackRange Passion	XF	Xrange Finline	WG	Warmgewalzt Laminazione a caldo

Alle Massangaben in mm
Unità di misura in mm

Kochinsel mehrteilig seitwärts an den Boden gezogen / Isola di cottura in più parti

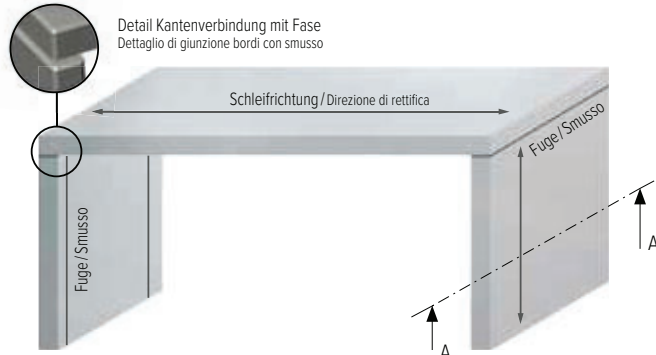

SmartSteel Collection mit Standardoberflächen / SmartSteel Collection con superfici standard

Schnitt A-A / Intaglio A-A

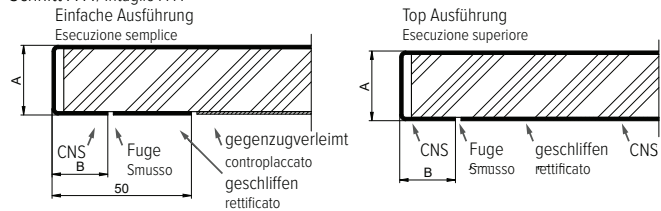

SmartSteel Collection mit Decor Oberflächen / SmartSteel Collection con superfici decor

Schnitt A-A / Intaglio A-A

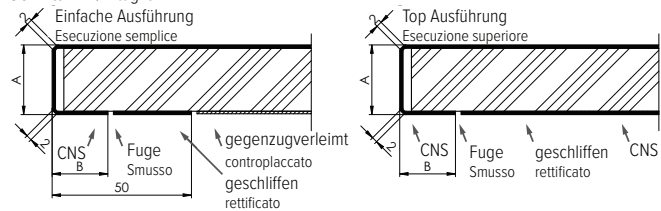

Erhältliche Ausführung / Lavorazione disponibile

SmartSteel Collection SolidSteel Collection

Weitere Produktinformationen / Altre informazioni prodotto 38

Erhältliche Oberflächen / Superfici disponibili

Standard	SF	BF	WF
Decor	PS	PB	TR

Weitere Produktinformationen / Altre informazioni prodotto 32+33

i Die Massanfertigung mit Seitenwangen wird aus Einzel-Schenkel gefertigt. Größere Abmessung, Quetschkante frontbündig sowie die Verbindung von Seitenwangen und Abstellfläche in der Gehrung auf Anfrage.

La soluzione su misura con spalle laterali viene realizzata con fianco unico. Dimensioni maggiori, bordo pressato a filo frontale, nonché la giunzione di spalle laterali e superficie d'appoggio nello smusso, sono su richiesta.

Abkantungen SmartSteel Collection / Piegature SmartSteel Collection

Erhältliche Kantenhöhe in mm (A)	12	15	20-100
Länge Abkantung in mm (B)	10	20	50

i Decor Oberflächen bis Kantenhöhe A40 erhältlich. Superficie Decor disponibile fino all'altezza di bordo A40.

Kochinsel mehrteilig seitwärts an den Boden gezogen / Isola di cottura in più parti

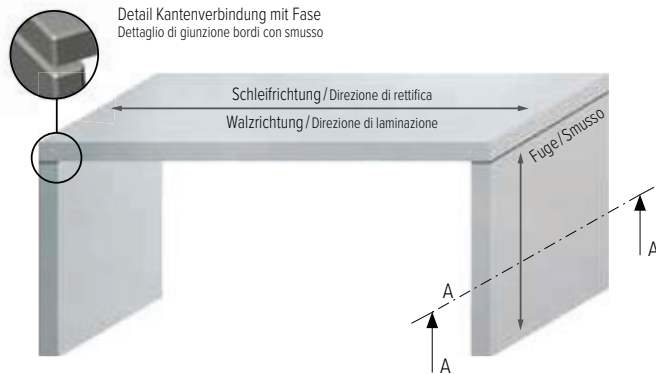

Schnitt A-A / Coupe A-A

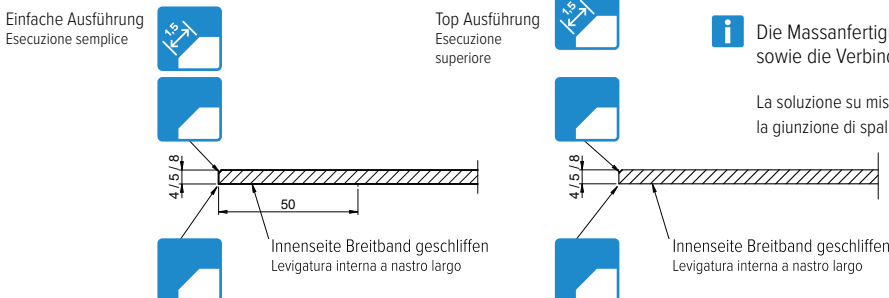

Erhältliche Ausführung / Lavorazione disponibile

SmartSteel Collection SolidSteel Collection

Weitere Produktinformationen / Altre informazioni prodotto 38

Erhältliche Oberflächen / Superfici disponibili

Standard	BF	WF							
Spezial	ID	BI	BP	PL	XI	XF	XB	SL	WG

Weitere Produktinformationen / Altre informazioni prodotto 32+34

i Die Massanfertigung mit Seitenwangen wird aus Einzel-Schenkel gefertigt. Größere Abmessung sowie die Verbindung von Seitenwangen und Abstellfläche in der Gehrung auf Anfrage.

La soluzione su misura con spalle laterali viene realizzata con fianco unico. Dimensioni maggiori, nonché la giunzione di spalle laterali e superficie d'appoggio nello smusso, sono su richiesta.

Standardoberflächen / Superfici standard

SF	Seidenmatt-Finish / Finitura satinata
BF	Breitband-Finish / Finitura a nastro largo
BX	Breitband Varix / Nastro largo Varix
WF	Wirbel-Finish / Finitura a turbino

Decor Oberflächen / Superfici Decor

PS	Polaris Silver
PB	Polaris Black
TR	Terra

Spezialoberflächen / Superfici speciali

ID	IceDesign™	PL	Polar Look	XB	Xrange Black
BI	BlackRange Industrial	XI	Xrange Ice	SL	Silk Look
BP	BlackRange Passion	XF	Xrange Fineline	WG	Warmgewalzt Laminazione a caldo

Alle Massangaben in mm
Unità di misura in mm

Überhängende Arbeitsplatte / Piano di lavoro sporgente

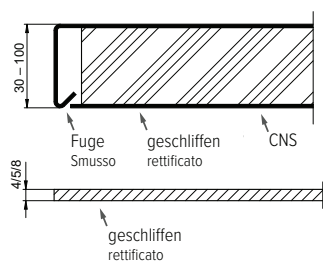
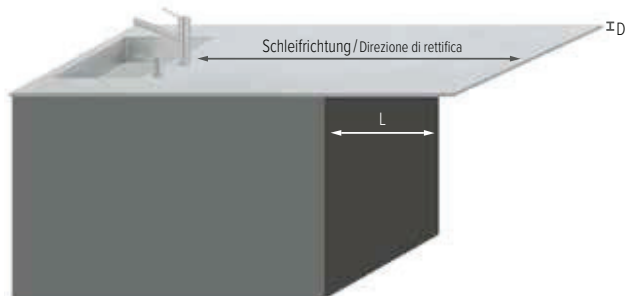

Kantenhöhe (D) / Altezze di bordo (D)		Überhang (L) / Sporgente (L)
SmartSteel Collection	SolidSteel Collection	
A12 – A20	4/5 mm	Auf Anfrage Su richiesta
A30	8 mm	300 mm
A40 – A100	–	500 mm

Erhältliche Ausführung / Lavorazione disponibile

SmartSteel Collection

SolidSteel Collection

Weitere Produktinformationen / Altre informazioni prodotto 38

Erhältliche Oberflächen / Superfici disponibili

Standard	SF	BF	WF						
Decor	PS	PB	TR						
Spezial	ID	BI	BP	PL	XI	XF	XB	SL	WG

Weitere Produktinformationen / Altre informazioni prodotto 32-36

i Montageempfehlung: Trägerplatte verwenden
 In Abhängigkeit der Einbausituation ist als zusätzliche Verstärkung ein Vierkant-/Rechteckrohr einzurechnen. Ist der Überhang grösser als die angegebenen Masse wird eine Abstützung empfohlen. Unabhängig von der Ausführung und der Oberfläche wird die sichtbare Unterseite in der Oberfläche Breitband-Finish ausgeführt.
 Raccomandazione per il montaggio: utilizzare una piastra di supporto
 A seconda della situazione di montaggio, come rinforzo supplementare occorre prevedere l'impiego di un tubo rettangolare/quadro. Se la sporgenza è maggiore della misura indicata, si raccomanda l'uso di un supporto. Indipendentemente dal tipo di esecuzione e dalla superficie, il lato inferiore a vista viene eseguito con finitura superficiale a nastro largo.

Schleifrichtungen / Direzione di rettifica



i Winkelförmige Massanfertigungen können in allen Winkelmassen ausgeführt werden. Bei Übergrößen muss je nach Transport- und Montagemöglichkeit in der Küche (Handling in einem Stück, Gewicht) eventuell eine Stecknaht oder eine Stossverbindung vorgesehen werden.

Nelle soluzioni su misura a sezione curva, le superfici curve e i telai devono essere saldati. Le soluzioni su misura ad angolo possono essere realizzate con angoli di qualsiasi misura. In caso di dimensioni speciali, a seconda delle possibilità di trasporto e di montaggio in cucina (gestione di un unico pezzo, peso) va eventualmente previsto un giunto a innesto sovrapposto, un giunto di testa o un collegamento a innesto.

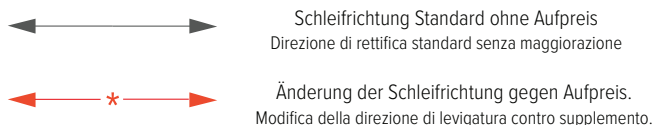

Standardoberflächen / Superfici standard

SF	Seidenmatt-Finish / Finitura satinata
BF	Breitband-Finish / Finitura a nastro largo
BX	Breitband Varix / Nastro largo Varix
WF	Wirbel-Finish / Finitura a turbino

Decor Oberflächen / Superfici Decor

PS	Polaris Silver
PB	Polaris Black
TR	Terra

Spezialoberflächen / Superfici speciali

ID	IceDesign™	PL	Polar Look	XB	Xrange Black
BI	BlackRange Industrial	XI	Xrange Ice	SL	Silk Look
BP	BlackRange Passion	XF	Xrange Finline	WG	Warmgewalzt Laminazione a caldo

Alle Massangaben in mm
Unità di misura in mm

Überhängende Arbeitsplatte Varix / Piano di lavoro sporgente Varix

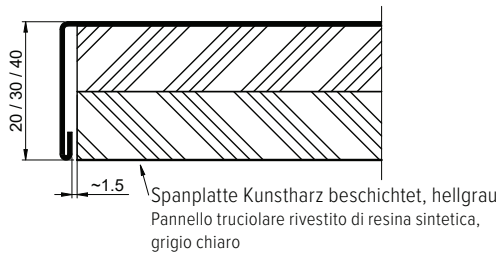
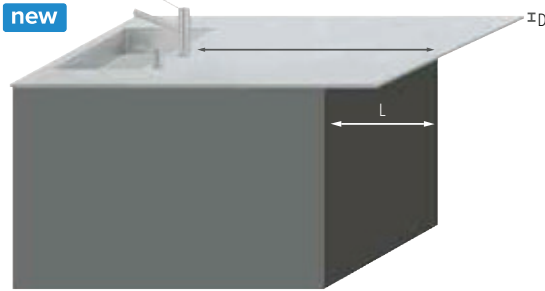

Kantenhöhe (D) / Altezza di bordo (D)	Überhang (L) / Sporgente (L)
SmartSteel Collection	
A20	max. 150 mm
A30	max. 200 mm
A40	max. 200 mm

Erhältliche Ausführung / Lavorazione disponibile

SmartSteel Collection



SolidSteel Collection



Weitere Produktinformationen / Altre informazioni prodotto 38

Erhältliche Oberflächen / Superfici disponibili

Standard



Weitere Produktinformationen / Altre informazioni prodotto 32

i Montageempfehlung: Trägerplatte verwenden
 In Abhängigkeit der Einbausituation ist als zusätzliche Verstärkung ein Vierkant-/Rechteckrohr einzurechnen. Ist der Überhang grösser als die angegebenen Masse wird eine Abstützung empfohlen.

Suggerimento per il montaggio: utilizzare una piastra di supporto
 A seconda della situazione d'installazione, è necessario includere un tubo quadrato/rettangolare come rinforzo aggiuntivo. Se la sporgenza è superiore alle dimensioni specificate, si consiglia di utilizzare un supporto.

Schleifrichtungen Varix / Direzione di rettifica Varix



i Winkelförmige Massanfertigungen können in allen Winkelmassen ausgeführt werden. In der Kantenausführung nur mit Stecknaht möglich.

Le soluzioni su misura ad angolo possono essere realizzate in tutte le dimensioni angolari. La bordatura possibile solo con un giunto a innesto.



Schleifrichtung Standard
 Direzione di rettifica standard

Standardoberflächen / Superfici standard

SF	Seidenmatt-Finish / Finitura satinata
BF	Breitband-Finish / Finitura a nastro largo
BX	Breitband Varix / Nastro largo Varix
WF	Wirbel-Finish / Finitura a turbino

Decor Oberflächen / Superfici Decor

PS	Polaris Silver
PB	Polaris Black
TR	Terra

Spezialoberflächen / Superfici speciali

ID	IceDesign™	PL	Polar Look	XB	Xrange Black
BI	BlackRange Industrial	XI	Xrange Ice	SL	Silk Look
BP	BlackRange Passion	XF	Xrange Finline	WG	Warmgewalzt Laminazione a caldo

Alle Massangaben in mm
 Unità di misura in mm

SolidArt für den flächenbündigen Einbau in bauseitiger Arbeitsplatte / SolidArt per montaggio a filo top su piano di lavoro predisposto in loco

Arbeitsplatte bauseits z.B. Holz, Stein, etc. / Piano di lavoro predisposto in loco, per es. legno, pietra, ecc.



Schleifrichtung / Direzione di rettifica

Formbeispiel / Esempio di forma

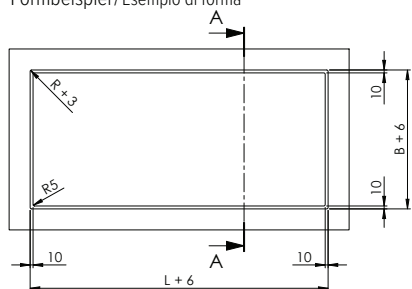

Schnitt A-A / Intaglio A-A

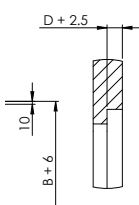

Erhältliche Ausführung / Lavorazione disponibile

SmartSteel Collection

-

SolidSteel Collection

✓

 Weitere Produktinformationen / Altre informazioni prodotto  38

Erhältliche Oberflächen / Superfici disponibili

Standard

BF WF

Spezial

ID BI BP PL XI XF XB SL WG

 Weitere Produktinformationen / Altre informazioni prodotto  32+34

 Form, Abmessung sowie Ausstattung nach Vorgabe.
 Forma, dimensioni e dotazione secondo specifica.

Standardoberflächen / Superfici standard

SF	Seidenmatt-Finish / Finitura satinata
BF	Breitband-Finish / Finitura a nastro largo
BX	Breitband Varix / Nastro largo Varix
WF	Wirbel-Finish / Finitura a turbino

Decor Oberflächen / Superfici Decor

PS	Polaris Silver
PB	Polaris Black
TR	Terra

Spezialoberflächen / Superfici speciali

ID	IceDesign™	PL	Polar Look	XB	Xrange Black
BI	BlackRange Industrial	XI	Xrange Ice	SL	Silk Look
BP	BlackRange Passion	XF	Xrange Finline	WG	Warmgewalzt Laminazione a caldo

 Alle Massangaben in mm
 Unità di misura in mm



Kantenausführung und -Design für SmartSteel Collection

Versioni e design di bordi in SmartSteel Collection



Kantenausführung und -Design Versioni e design di bordi	SmartSteel Collection	Erhältlich für Oberfläche Disponibile per superficie
1 Kante geschliffen Bordo rettificato	✓	Standard SF BF BX WF Decor PS PB TR
2 Kante Hochglanz poliert Bordo lucidato a specchio	✓	Decor PS PB TR
3 Kante ohne Fase (Radius) Bordo senza smusso (raggio)	✓	Standard SF BF BX WF
4 Kante mit Fase 1.5/45° Bordo con smusso 1.5/45°	✓	Standard SF BF BX WF Decor PS PB TR

i Bei Standardoberflächen wird seitlich der entsprechende Oberflächenschliff angewendet (z.B. Wirbel-Finish).
Sui lati delle superfici standard viene utilizzata la rispettiva rettifica superficiale (per es. finitura a turbini).

Schleifrichtung Varix s. Seite 49
Senso di levigatura Varix, vedi pagina 49

Standardoberflächen / Superfici standard

SF	Seidenmatt-Finish / Finitura satinata
BF	Breitband-Finish / Finitura a nastro largo
BX	Breitband Varix / Nastro largo Varix
WF	Wirbel-Finish / Finitura a turbino

Decor Oberflächen / Superfici Decor

PS	Polaris Silver
PB	Polaris Black
TR	Terra

Spezialoberflächen / Superfici speciali

ID	IceDesign™	PL	Polar Look	XB	Xrange Black
BI	BlackRange Industrial	XI	Xrange Ice	SL	Silk Look
BP	BlackRange Passion	XF	Xrange Fineline	WG	Warmgewalzt Laminazione a caldo

Alle Massangaben in mm
Unità di misura in mm

Kantenausführung und -Design für SolidSteel Collection

Versioni e design di bordi in SolidSteel Collection



Massanfertigungen
Soluzioni a misura

Kantenausführung und -Design Versioni e design di bordi		SolidSteel Collection	Erhältlich für Oberfläche Disponibile per superficie	
1	Kante geschnitten Bordo tagliato	✓	Standard: BF, WF Spezial: ID, BI, BP, PL, XI, XF, XB, SL, WG	
2	Kante geschliffen Bordo rettificato	✓	Standard: BF, WF Spezial: ID, BI, BP, PL, XI, XF, XB, SL, WG	
3	Ohne Fase (gebrochen) Senza smusso (spezzato)	✓	Standard: BF, WF Spezial: ID, BI, BP, PL, XI, XF, XB, SL, WG	
4	Kante mit Fase 0.5/45° Bordo con smusso 0.5/45°	✓	Standard: BF, WF Spezial: ID, BI, BP, PL, XI, XF, XB, SL, WG	
5	Kante mit Fase 1.0/45° Bordo con smusso 1.0/45°	✓	Standard: BF, WF Spezial: ID, BI, BP, PL, XI, XF, XB, SL, WG	

Standardoberflächen / Superfici standard

SF	Seidenmatt-Finish / Finitura satinata
BF	Breitband-Finish / Finitura a nastro largo
BX	Breitband Varix / Nastro largo Varix
WF	Wirbel-Finish / Finitura a turbino

Decor Oberflächen / Superfici Decor

PS	Polaris Silver
PB	Polaris Black
TR	Terra

Spezialoberflächen / Superfici speciali

ID	IceDesign™	PL	Polar Look	XB	Xrange Black
BI	BlackRange Industrial	XI	Xrange Ice	SL	Silk Look
BP	BlackRange Passion	XF	Xrange Finline	WG	Warmgewalzt Laminazione a caldo

Alle Massangaben in mm
Unità di misura in mm

SmartSteel Collection

Kante A12 / Bordo A12

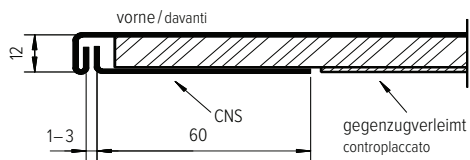

Erhältliche Oberflächen Superfici disponibili

Standard SF BF WF

Decor PS PB TR

Weitere Produktinformationen / Altre informazioni prodotto  32+33

	Kantenausführung Lavorazione dei bordi		Kantendesign Design bordi	
	geschliffen rettificato	Hochglanz poliert Lucidato a specchio	ohne Fase (Radius) senza smusso (raggio)	mit Fase con smusso
Standard	✓	–	✓	✓
Decor	✓	✓	–	✓

Weitere Produktinformationen / Altre informazioni prodotto  38

i Nicht sichtbare Kanten werden ohne Bearbeitung ausgeführt.
I bordi non a vista vengono eseguiti senza alcuna lavorazione.

Kante A15 / Bordo A15

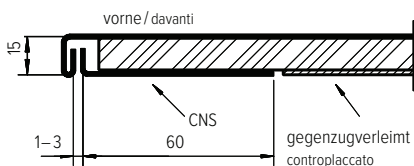

Erhältliche Oberflächen Superfici disponibili

Standard SF BF WF

Decor PS PB TR

Weitere Produktinformationen / Altre informazioni prodotto  32+33

	Kantenausführung Lavorazione dei bordi		Kantendesign Design bordi	
	geschliffen rettificato	Hochglanz poliert Lucidato a specchio	ohne Fase (Radius) senza smusso (raggio)	mit Fase con smusso
Standard	✓	–	✓	✓
Decor	✓	✓	–	✓

Weitere Produktinformationen / Altre informazioni prodotto  38

i Nicht sichtbare Kanten werden ohne Bearbeitung ausgeführt.
I bordi non a vista vengono eseguiti senza alcuna lavorazione.

Standardoberflächen / Superfici standard

SF	Seidenmatt-Finish / Finitura satinata
BF	Breitband-Finish / Finitura a nastro largo
BX	Breitband Varix / Nastro largo Varix
WF	Wirbel-Finish / Finitura a turbino

Decor Oberflächen / Superfici Decor

PS	Polaris Silver
PB	Polaris Black
TR	Terra

Spezialoberflächen / Superfici speciali

ID	IceDesign™	PL	Polar Look	XB	Xrange Black
BI	BlackRange Industrial	XI	Xrange Ice	SL	Silk Look
BP	BlackRange Passion	XF	Xrange Finline	WG	Warmgewalzt Laminazione a caldo

Alle Massangaben in mm
Unità di misura in mm

Kante A20 / Bordo A20

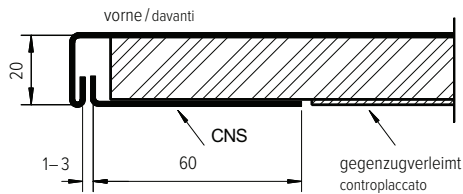

Erhältliche Oberflächen
Superfici disponibili

Standard	SF	BF	WF
Decor	PS	PB	TR

Weitere Produktinformationen / Altre informazioni prodotto  32+33

	Kantenausführung Lavorazione dei bordi		Kantendesign Design bordi	
	geschliffen rettificato	Hochglanz poliert Lucidato a specchio	ohne Fase (Radius) senza smusso (raggio)	mit Fase con smusso
Standard	✓	–	✓	✓
Decor	✓	✓	–	✓

Weitere Produktinformationen / Altre informazioni prodotto  38

i Nicht sichtbare Kanten werden ohne Bearbeitung ausgeführt.
I bordi non a vista vengono eseguiti senza alcuna lavorazione.

Kante A20 Varix / Bordo A20 Varix



Erhältliche Oberflächen
Superfici disponibili

Standard	SF	BF	BX	WF
----------	----	----	----	----

Weitere Produktinformationen / Altre informazioni prodotto  32

	Kantenausführung Lavorazione dei bordi		Kantendesign Design bordi	
	geschliffen rettificato	Hochglanz poliert Lucidato a specchio	ohne Fase (Radius) senza smusso (raggio)	mit Fase con smusso
Standard	✓	–	✓	✓

Weitere Produktinformationen / Altre informazioni prodotto  38

i Nicht sichtbare Kanten werden ohne Bearbeitung ausgeführt.
I bordi non a vista vengono eseguiti senza alcuna lavorazione.

Schleifrichtungen Varix, s. Seite 49
Direzione di rettifica Varix sulla pag. 49

Standardoberflächen / Superfici standard

SF	Seidenmatt-Finish / Finitura satinata
BF	Breitband-Finish / Finitura a nastro largo
BX	Breitband Varix / Nastro largo Varix
WF	Wirbel-Finish / Finitura a turbino

Decor Oberflächen / Superfici Decor

PS	Polaris Silver
PB	Polaris Black
TR	Terra

Spezialoberflächen / Superfici speciali

ID	IceDesign™	PL	Polar Look	XB	Xrange Black
BI	BlackRange Industrial	XI	Xrange Ice	SL	Silk Look
BP	BlackRange Passion	XF	Xrange Finline	WG	Warmgewalzt Laminazione a caldo

Alle Massangaben in mm
Unità di misura in mm

SmartSteel Collection

Kante A30 / Bordo A30

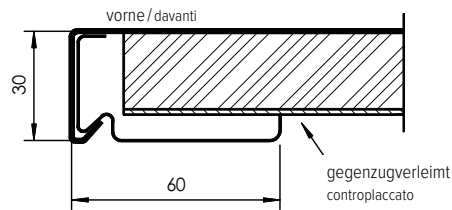

Erhältliche Oberflächen Superfici disponibili

Standard	SF	BF	WF
Decor	PS	PB	TR

Weitere Produktinformationen / Altre informazioni prodotto  32+33

	Kantenausführung Lavorazione dei bordi		Kantendesign Design bordi	
	geschliffen rettificato	Hochglanz poliert Lucidato a specchio	ohne Fase (Radius) senza smusso (raggio)	mit Fase con smusso
Standard	✓	–	✓	✓
Decor	✓	–	–	✓

Weitere Produktinformationen / Altre informazioni prodotto  38

i Nicht sichtbare Kanten werden ohne Bearbeitung ausgeführt.
I bordi non a vista vengono eseguiti senza alcuna lavorazione.

Kante A30 Varix / Bordo A30 Varix

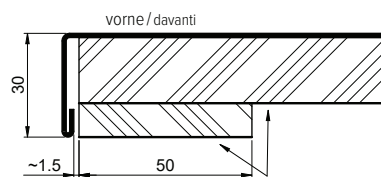

Spanplatte Kunstharz beschichtet, hellgrau
Pannello truciolare rivestito di resina sintetica,
grigio chiaro

Erhältliche Oberflächen Superfici disponibili

Standard	SF	BF	BX	WF
----------	----	----	----	----

Weitere Produktinformationen / Altre informazioni prodotto  32

	Kantenausführung Lavorazione dei bordi		Kantendesign Design bordi	
	geschliffen rettificato	Hochglanz poliert Lucidato a specchio	ohne Fase (Radius) senza smusso (raggio)	mit Fase con smusso
Standard	✓	–	✓	✓

Weitere Produktinformationen / Altre informazioni prodotto  38

i Nicht sichtbare Kanten werden ohne Bearbeitung ausgeführt.
I bordi non a vista vengono eseguiti senza alcuna lavorazione.

Schleifrichtungen Varix, s. Seite 49
Direzione di rettifica Varix sulla pag. 49

Standardoberflächen / Superfici standard

SF	Seidenmatt-Finish / Finitura satinata
BF	Breitband-Finish / Finitura a nastro largo
BX	Breitband Varix / Nastro largo Varix
WF	Wirbel-Finish / Finitura a turbino

Decor Oberflächen / Superfici Decor

PS	Polaris Silver
PB	Polaris Black
TR	Terra

Spezialoberflächen / Superfici speciali

ID	IceDesign™	PL	Polar Look	XB	Xrange Black
BI	BlackRange Industrial	XI	Xrange Ice	SL	Silk Look
BP	BlackRange Passion	XF	Xrange Finline	WG	Warmgewalzt Laminazione a caldo

Alle Massangaben in mm
Unità di misura in mm

Kante A40 / Bordo A40

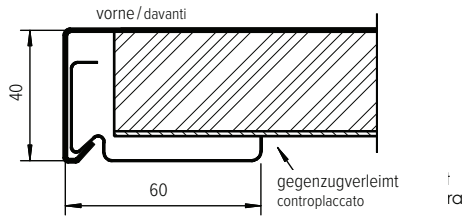

Erhältliche Oberflächen
Superfici disponibili

Standard	SF	BF	WF
Decor	PS	PB	TR

Weitere Produktinformationen / Altre informazioni prodotto  32+33

	Kantenausführung Lavorazione dei bordi		Kantendesign Design bordi	
	geschliffen rettificato	Hochglanz poliert Lucidato a specchio	ohne Fase (Radius) senza smusso (raggio)	mit Fase con smusso
Standard	✓	–	✓	✓
Decor	✓	–	–	✓

Weitere Produktinformationen / Altre informazioni prodotto  38

i Nicht sichtbare Kanten werden ohne Bearbeitung ausgeführt.
I bordi non a vista vengono eseguiti senza alcuna lavorazione.

Kante A40 Varix / Bordo A40 Varix

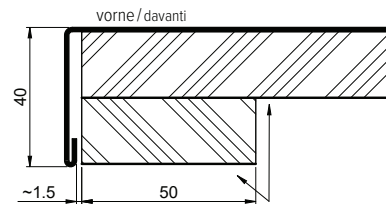

Spanplatte Kunstharz beschichtet, hellgrau
Pannello truciolare rivestito di resina sintetica,
grigio chiaro

Erhältliche Oberflächen
Superfici disponibili

Standard	SF	BF	BX	WF
----------	----	----	----	----

Weitere Produktinformationen / Altre informazioni prodotto  32

	Kantenausführung Lavorazione dei bordi		Kantendesign Design bordi	
	geschliffen rettificato	Hochglanz poliert Lucidato a specchio	ohne Fase (Radius) senza smusso (raggio)	mit Fase con smusso
Standard	✓	–	✓	✓

Weitere Produktinformationen / Altre informazioni prodotto  38

i Nicht sichtbare Kanten werden ohne Bearbeitung ausgeführt.
I bordi non a vista vengono eseguiti senza alcuna lavorazione.

Schleifrichtungen Varix, s. Seite 49
Direzione di rettifica Varix sulla pag. 49

Standardoberflächen / Superfici standard

SF	Seidenmatt-Finish / Finitura satinata
BF	Breitband-Finish / Finitura a nastro largo
BX	Breitband Varix / Nastro largo Varix
WF	Wirbel-Finish / Finitura a turbino

Decor Oberflächen / Superfici Decor

PS	Polaris Silver
PB	Polaris Black
TR	Terra

Spezialoberflächen / Superfici speciali

ID	IceDesign™	PL	Polar Look	XB	Xrange Black
BI	BlackRange Industrial	XI	Xrange Ice	SL	Silk Look
BP	BlackRange Passion	XF	Xrange Finline	WG	Warmgewalzt Laminazione a caldo

Alle Massangaben in mm
Unità di misura in mm

Kante A50 – A100 / Bordo A50 – A100

Erhältliche Oberflächen
Superfici disponibili
Standard **SF** **BF** **WF**

Weitere Produktinformationen / Altre informazioni prodotto 32

Kantenausführung Lavorazione dei bordi		Kantendesign Design bordi	
geschliffen rettificato	Hochglanz poliert Lucidato a specchio	ohne Fase (Radius) senza smusso (raggio)	mit Fase con smusso
✓	–	✓	✓

Weitere Produktinformationen / Altre informazioni prodotto 38

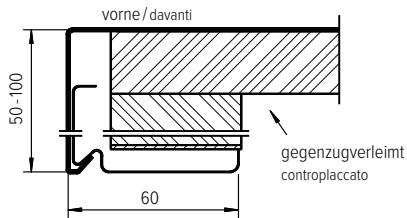
 Nicht sichtbare Kanten werden ohne Bearbeitung ausgeführt.
 I bordi non a vista vengono eseguiti senza alcuna lavorazione.

Standardoberflächen / Superfici standard

SF	Seidenmatt-Finish / Finitura satinata
BF	Breitband-Finish / Finitura a nastro largo
BX	Breitband Varix / Nastro largo Varix
WF	Wirbel-Finish / Finitura a turbino

Decor Oberflächen / Superfici Decor

PS	Polaris Silver
PB	Polaris Black
TR	Terra

Spezialoberflächen / Superfici speciali

ID	IceDesign™	PL	Polar Look	XB	Xrange Black
BI	BlackRange Industrial	XI	Xrange Ice	SL	Silk Look
BP	BlackRange Passion	XF	Xrange Fineline	WG	Warmgewalzt Laminazione a caldo

Alle Massangaben in mm
Unità di misura in mm

Quetschkante A20 frontbündig / Bordo pressato a filo frontale A20



**Erhältliche Oberflächen
Superfici disponibili**

Standard **SF** **BF** **WF**

Weitere Produktinformationen / Altre informazioni prodotto 32

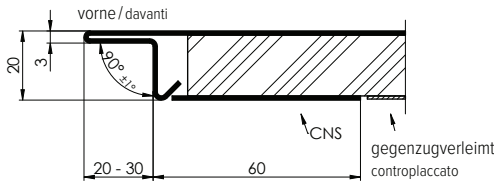

Kantenausführung Lavorazione dei bordi		Kantendesign Design bordi	
geschliffen rettificato	Hochglanz poliert Lucidato a specchio	ohne Fase senza smusso	mit Fase con smusso
✓	-	✓	-

Weitere Produktinformationen / Altre informazioni prodotto 38

i Quetschkante allseitig anwendbar. Rücksprung 20–30 mm (in mm Schritten) möglich.
Bordo pressato applicabile su ogni lato. Possibile rientro di 20–30 mm (ad incrementi di 1 mm).

Quetschkante A20 frontbündig Varix / Bordo pressato a filo frontale A20 Varix



**Erhältliche Oberflächen
Superfici disponibili**

Standard **SF** **BF** **BX** **WF**

Weitere Produktinformationen / Altre informazioni prodotto 32

Kantenausführung Lavorazione dei bordi		Kantendesign Design bordi	
geschliffen rettificato	Hochglanz poliert Lucidato a specchio	ohne Fase senza smusso	mit Fase con smusso
✓	-	✓	-

Weitere Produktinformationen / Altre informazioni prodotto 38

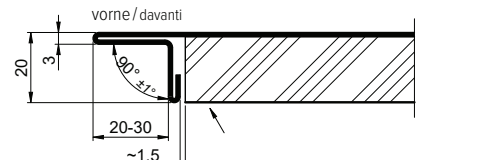

Spanplatte Kunstharz beschichtet, hellgrau
Pannello truciolare rivestito di resina sintetica,
grigio chiaro

i Quetschkante vorne möglich. Andere Seiten nach Abklärung. Rücksprung 20–30 mm (in mm Schritten) möglich.
Bordo pressato anteriore possibile. Altri lati dopo relativi chiarimenti. Rientro di 20 – 30 mm (con incrementi di mm) possibile.

Schleifrichtungen Varix, s. Seite 49
Direzione di rettifica Varix sulla pag. 49

Standardoberflächen / Superfici standard

SF	Seidenmatt-Finish / Finitura satinata
BF	Breitband-Finish / Finitura a nastro largo
BX	Breitband Varix / Nastro largo Varix
WF	Wirbel-Finish / Finitura a turbino

Decor Oberflächen / Superfici Decor

PS	Polaris Silver
PB	Polaris Black
TR	Terra

Spezialoberflächen / Superfici speciali

ID	IceDesign™	PL	Polar Look	XB	Xrange Black
BI	BlackRange Industrial	XI	Xrange Ice	SL	Silk Look
BP	BlackRange Passion	XF	Xrange Finline	WG	Warmgewalzt Laminazione a caldo

Alle Massangaben in mm
Unità di misura in mm

Quetschkante A30 frontbündig / Bordo pressato a filo frontale A30

Erhältliche Oberflächen
Superfici disponibili

Standard SF BF WF

Weitere Produktinformationen / Altre informazioni prodotto 32

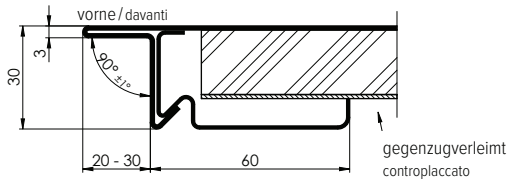

Weitere Produktinformationen / Altre informazioni prodotto 38

Kantenausführung Lavorazione dei bordi		Kantendesign Design bordi	
geschliffen rettificato	Hochglanz poliert Lucidato a specchio	ohne Fase senza smusso	mit Fase con smusso
✓	-	✓	-

i Quetschkante allseitig anwendbar. Rücksprung 20–30 mm (in mm Schritten) möglich.
 Bordo pressato applicabile su ogni lato. Possibile rientro di 20–30 mm (ad incrementi di 1 mm).

Quetschkante A30 frontbündig Varix / Bordo pressato a filo frontale A30 Varix

Erhältliche Oberflächen
Superfici disponibili

Standard SF BF BX WF

Weitere Produktinformationen / Altre informazioni prodotto 32

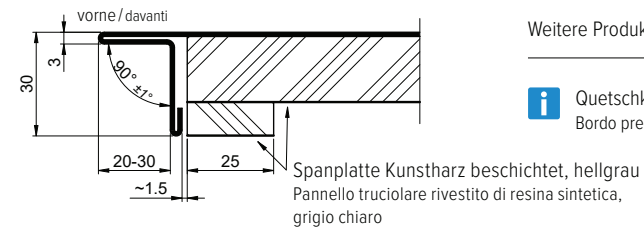

Weitere Produktinformationen / Altre informazioni prodotto 38

Kantenausführung Lavorazione dei bordi		Kantendesign Design bordi	
geschliffen rettificato	Hochglanz poliert Lucidato a specchio	ohne Fase senza smusso	mit Fase con smusso
✓	-	✓	-

i Quetschkante vorne möglich. Andere Seiten nach Abklärung. Rücksprung 20–30 mm (in mm Schritten) möglich.
 Bordo pressato anteriore possibile. Altri lati dopo relativi chiarimenti. Rientro di 20–30 mm (con incrementi di mm) possibile.

Standardoberflächen / Superfici standard

SF	Seidenmatt-Finish / Finitura satinata
BF	Breitband-Finish / Finitura a nastro largo
BX	Breitband Varix / Nastro largo Varix
WF	Wirbel-Finish / Finitura a turbino

Decor Oberflächen / Superfici Decor

PS	Polaris Silver
PB	Polaris Black
TR	Terra

Spezialoberflächen / Superfici speciali

ID	IceDesign™	PL	Polar Look	XB	Xrange Black
BI	BlackRange Industrial	XI	Xrange Ice	SL	Silk Look
BP	BlackRange Passion	XF	Xrange Finline	WG	Warmgewalzt Laminazione a caldo

 Alle Massangaben in mm
 Unità di misura in mm

Quetschkante A40 frontbündig / Bordo pressato a filo frontale A40



**Erhältliche Oberflächen
Superfici disponibili**

Standard SF BF WF

Weitere Produktinformationen / Altre informazioni prodotto 32

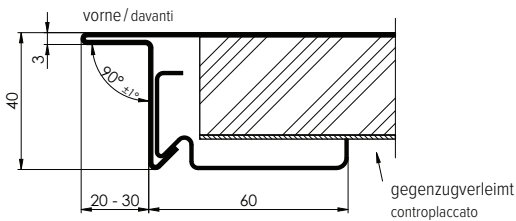

Kantenausführung Lavorazione dei bordi		Kantendesign Design bordi	
geschliffen rettificato	Hochglanz poliert Lucidato a specchio	ohne Fase senza smusso	mit Fase con smusso
✓	-	✓	-

Weitere Produktinformationen / Altre informazioni prodotto 38

i Quetschkante allseitig anwendbar. Rücksprung 20–30 mm (in mm Schritten) möglich. Für Kantenausführung grösser als A40 auf Anfrage.

Bordo pressato applicabile su ogni lato. Possibile rientro di 20–30 mm (ad incrementi di 1 mm). Su richiesta, esecuzione di bordi maggiori di A40.

Quetschkante A40 frontbündig Varix / Bordo pressato a filo frontale A40 Varix



**Erhältliche Oberflächen
Superfici disponibili**

Standard SF BF BX WF

Weitere Produktinformationen / Altre informazioni prodotto 32

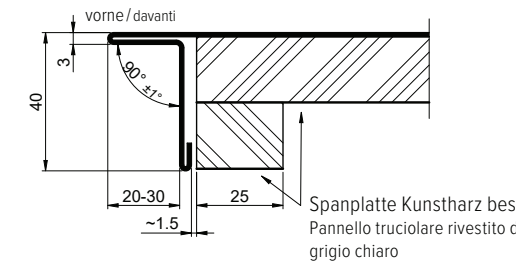

Kantenausführung Lavorazione dei bordi		Kantendesign Design bordi	
geschliffen rettificato	Hochglanz poliert Lucidato a specchio	ohne Fase senza smusso	mit Fase con smusso
✓	-	✓	-

Weitere Produktinformationen / Altre informazioni prodotto 38

i Quetschkante vorne möglich. Andere Seiten nach Abklärung. Rücksprung 20–30 mm (in mm Schritten) möglich. Für Kantenausführung grösser als A40 auf Anfrage.

Bordo pressato anteriore possibile. Altri lati dopo relativi chiarimenti. Rientro di 20 – 30 mm (con incrementi di mm) possibile. Per bordi superiori ad A40 su richiesta.

Standardoberflächen / Superfici standard

SF	Seidenmatt-Finish / Finitura satinata
BF	Breitband-Finish / Finitura a nastro largo
BX	Breitband Varix / Nastro largo Varix
WF	Wirbel-Finish / Finitura a turbino

Decor Oberflächen / Superfici Decor

PS	Polaris Silver
PB	Polaris Black
TR	Terra

Spezialoberflächen / Superfici speciali

ID	IceDesign™	PL	Polar Look	XB	Xrange Black
BI	BlackRange Industrial	XI	Xrange Ice	SL	Silk Look
BP	BlackRange Passion	XF	Xrange Finline	WG	Warmgewalzt Laminazione a caldo

Alle Massangaben in mm
Unità di misura in mm

Kante zum Anpassen A30GS – A100GS / Bordo da adattare A30GS – A100GS

Erhältliche Oberflächen
Superfici disponibili

Standard SF BF WF

Weitere Produktinformationen / Altre informazioni prodotto  32

i Die Kantenausführungen A30GS – A100GS sind auf Wunsch zum Anpassen bauseits erhältlich.
Lavorazioni di bordi A30GS – A100GS disponibili in versione adattabile a cura del committente.

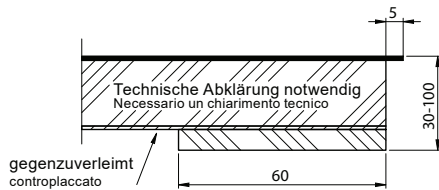

Kante zum Anpassen A20GS – A40GS Varix / Bordo da adattare A20GS – A40GS Varix



Erhältliche Oberflächen
Superfici disponibili

Standard SF BF BX WF

Weitere Produktinformationen / Altre informazioni prodotto  32

i Die Kantenausführungen A20GS – A40GS sind auf Wunsch zum Anpassen bauseits erhältlich.
Nur seitlich eine Seite möglich.
Le bordature A20GS – A40GS sono disponibili su richiesta in versione adattabile a cura del cliente.
Solo un lato possibile.

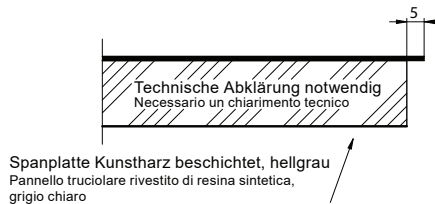
Schleifrichtungen Varix, s. Seite 49
Direzione di rettifica Varix sulla pag. 49



Standardoberflächen / Superfici standard

SF	Seidenmatt-Finish / Finitura satinata
BF	Breitband-Finish / Finitura a nastro largo
BX	Breitband Varix / Nastro largo Varix
WF	Wirbel-Finish / Finitura a turbino

Decor Oberflächen / Superfici Decor

PS	Polaris Silver
PB	Polaris Black
TR	Terra

Spezialoberflächen / Superfici speciali

ID	IceDesign™	PL	Polar Look	XB	Xrange Black
BI	BlackRange Industrial	XI	Xrange Ice	SL	Silk Look
BP	BlackRange Passion	XF	Xrange Fineline	WG	Warmgewalzt Laminazione a caldo

Alle Massangaben in mm
Unità di misura in mm

SolidSteel Collection

Kante 4 mm / Bordo 4 mm

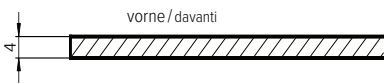

Erhältliche Oberflächen Superfici disponibili

Standard	BF	WF		
Spezial	ID	PL	SL	WG

Weitere Produktinformationen / Altre informazioni prodotto  32+34

	Kantenausführung Lavorazione dei bordi		Kantendesign Design bordi	
	geschnitten tagliato	geschliffen rettificato	ohne Fase (gebrochen) senza smusso (spezzato)	mit Fase con smusso
Standard	✓	✓	✓	✓
Spezial	✓	✓	✓	✓

Weitere Produktinformationen / Altre informazioni prodotto  38

i Montageempfehlung: Trägerplatte verwenden. Nicht sichtbare Kanten werden ohne Bearbeitung ausgeführt.
Raccomandazione per il montaggio: utilizzare piastra di supporto. I bordi non a vista vengono eseguiti senza alcuna lavorazione.

Kante 5 mm / Bordo 5 mm

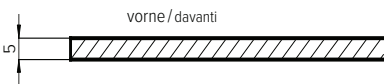

Erhältliche Oberflächen Superfici disponibili

Standard	BF	WF	
Spezial	XI	XF	XB

Weitere Produktinformationen / Altre informazioni prodotto  32+34

	Kantenausführung Lavorazione dei bordi		Kantendesign Design bordi	
	geschnitten tagliato	geschliffen rettificato	ohne Fase (gebrochen) senza smusso (spezzato)	mit Fase con smusso
Standard	✓	✓	✓	✓
Spezial	✓	✓	✓	✓

Weitere Produktinformationen / Altre informazioni prodotto  38

i Montageempfehlung: Trägerplatte verwenden. Nicht sichtbare Kanten werden ohne Bearbeitung ausgeführt.
Raccomandazione per il montaggio: utilizzare piastra di supporto. I bordi non a vista vengono eseguiti senza alcuna lavorazione.

Standardoberflächen / Superfici standard

SF	Seidenmatt-Finish / Finitura satinata
BF	Breitband-Finish / Finitura a nastro largo
BX	Breitband Varix / Nastro largo Varix
WF	Wirbel-Finish / Finitura a turbino

Decor Oberflächen / Superfici Decor

PS	Polaris Silver
PB	Polaris Black
TR	Terra

Spezialoberflächen / Superfici speciali

ID	IceDesign™	PL	Polar Look	XB	Xrange Black
BI	BlackRange Industrial	XI	Xrange Ice	SL	Silk Look
BP	BlackRange Passion	XF	Xrange Finline	WG	Warmgewalzt Laminazione a caldo

Alle Massangaben in mm
Unità di misura in mm

Kante 8 mm / Bordo 8 mm

Erhältliche Oberflächen
Superfici disponibili

Standard BF WF

Spezial ID BI BP PL SL WG

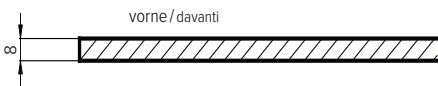
Weitere Produktinformationen / Altre informazioni prodotto  32+34**Kantenausführung****Lavorazione dei bordi**geschnitten
tagliatogeschliffen
rettificato**Kantendesign****Design bordi**ohne Fase (gebrochen)
senza smusso (spezzato)mit Fase
con smusso

Standard

✓

✓

✓

✓

Spezial

✓

✓

✓

✓

Weitere Produktinformationen / Altre informazioni prodotto  38

Montageempfehlung: Trägerplatte verwenden. Nicht sichtbare Kanten werden ohne Bearbeitung ausgeführt.

Raccomandazione per il montaggio: utilizzare piastra di supporto. I bordi non a vista vengono eseguiti senza alcuna lavorazione.

Standardoberflächen / Superfici standard

SF	Seidenmatt-Finish / Finitura satinata
BF	Breitband-Finish / Finitura a nastro largo
BX	Breitband Varix / Nastro largo Varix
WF	Wirbel-Finish / Finitura a turbino

Decor Oberflächen / Superfici Decor

PS	Polaris Silver
PB	Polaris Black
TR	Terra

Spezialoberflächen / Superfici speciali

ID	IceDesign™	PL	Polar Look	XB	Xrange Black
BI	BlackRange Industrial	XI	Xrange Ice	SL	Silk Look
BP	BlackRange Passion	XF	Xrange Finline	WG	Warmgewalzt Laminazione a caldo

Alle Massangaben in mm
Unità di misura in mm

Zargenausführungen für / Versioni di telaio per SmartSteel Collection

Zarge Höhe H20 – H50 mm / Altezza telaio H20 – H50 mm

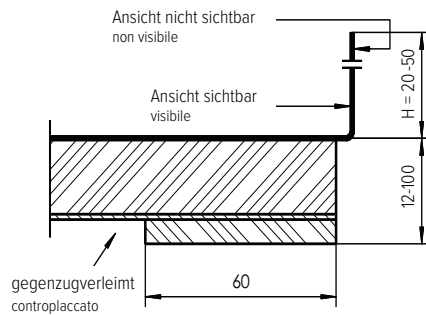
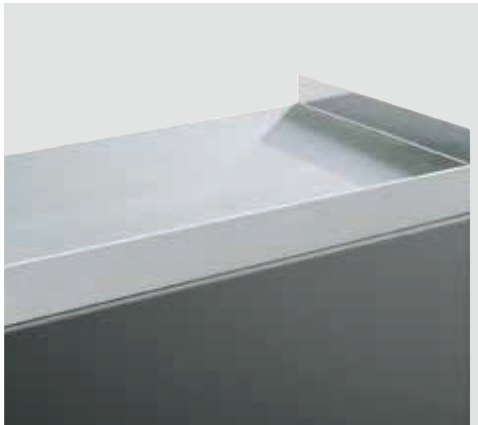

Erhältliche Oberflächen / Superfici disponibili

Standard SF BF WF

Weitere Produktinformationen / Altre informazioni prodotto  32

i Für Fertigwände mit oder ohne Silikonabdichtung. Zargen höher als 50 mm auf Anfrage. Ohne Befestigungslöcher.
Per pareti finite con o senza guarnizione in silicone. Telai più alti di 50 mm solo su richiesta. Senza fori di fissaggio.

Zarge Höhe H20 – H50 mm Varix / Altezza telaio H20 – H50 mm Varix

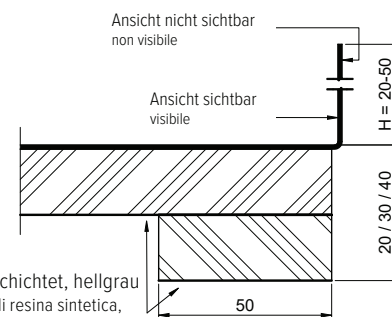

Spanplatte Kunstharz beschichtet, hellgrau
Pannello truciolare rivestito di resina sintetica, grigio chiaro

Erhältliche Oberflächen / Superfici disponibili

Standard SF BF BX WF

Weitere Produktinformationen / Altre informazioni prodotto  32

i Für Fertigwände mit oder ohne Silikonabdichtung. Ohne Befestigungslöcher.
Per pareti finite con o senza guarnizione in silicone. Senza fori di fissaggio.

Varix (BX) hinten möglich. Mehrseitig nach Abklärung.
Varix (BX) possibile sul retro. Più lati dopo relativi chiarimenti.

Schleifrichtungen Varix, s. Seite 49
Direzione di rettifica Varix sulla pag. 49

Standardoberflächen / Superfici standard

SF	Seidenmatt-Finish / Finitura satinata
BF	Breitband-Finish / Finitura a nastro largo
BX	Breitband Varix / Nastro largo Varix
WF	Wirbel-Finish / Finitura a turbino

Decor Oberflächen / Superfici Decor

PS	Polaris Silver
PB	Polaris Black
TR	Terra

Spezialoberflächen / Superfici speciali

ID	IceDesign™	PL	Polar Look	XB	Xrange Black
BI	BlackRange Industrial	XI	Xrange Ice	SL	Silk Look
BP	BlackRange Passion	XF	Xrange Finline	WG	Warmgewalzt Laminazione a caldo

Alle Massangaben in mm
Unità di misura in mm

Zarge C40 mit Nagelrand / Telaio C40 con bordo chiodato

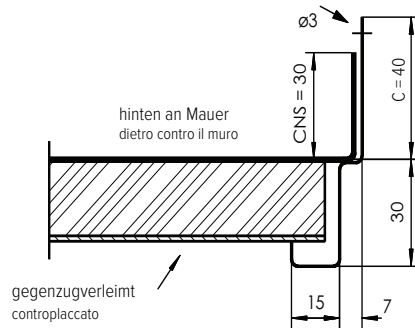

Erhältliche Oberflächen / Superfici disponibili

Standard SF BF WF

Weitere Produktinformationen / Altre informazioni prodotto  32

i Für Plättlizarge mit Befestigungslöcher.
Per telaio sottopiastrella con fori di fissaggio.

Standardoberflächen / Superfici standard

SF	Seidenmatt-Finish / Finitura satinata
BF	Breitband-Finish / Finitura a nastro largo
BX	Breitband Varix / Nastro largo Varix
WF	Wirbel-Finish / Finitura a turbino

Decor Oberflächen / Superfici Decor

PS	Polaris Silver
PB	Polaris Black
TR	Terra

Spezialoberflächen / Superfici speciali

ID	IceDesign™	PL	Polar Look	XB	Xrange Black
BI	BlackRange Industrial	XI	Xrange Ice	SL	Silk Look
BP	BlackRange Passion	XF	Xrange Finline	WG	Warmgewalzt Laminazione a caldo

Alle Massangaben in mm
Unità di misura in mm

Zarge C30-8 – C100-8 / Telaio C30-8 – C100-8

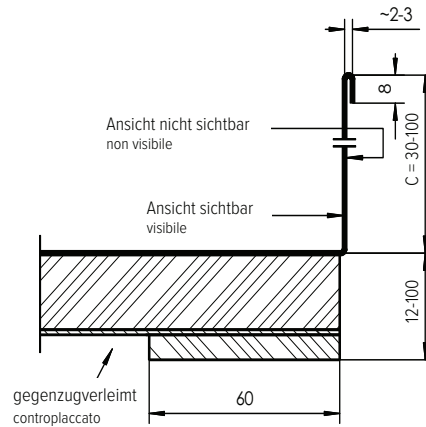
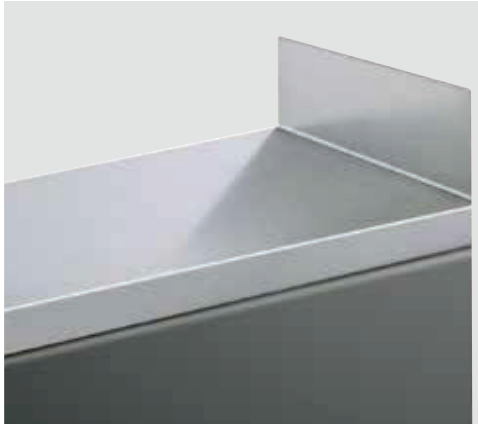

Erhältliche Oberflächen / Superfici disponibili

Standard SF BF WF

Weitere Produktinformationen / Altre informazioni prodotto 32

i Für Fertigwände mit Silikonabdichtung.
Zargenabschluss verschweisst auf Wunsch erhältlich.
Per pareti finite con guarnizione in silicone.
Su richiesta, disponibilità di chiusura telaio saldata.

Zarge C30-8 – C50-8 Varix / Telaio C30-8 – C50-8 Varix

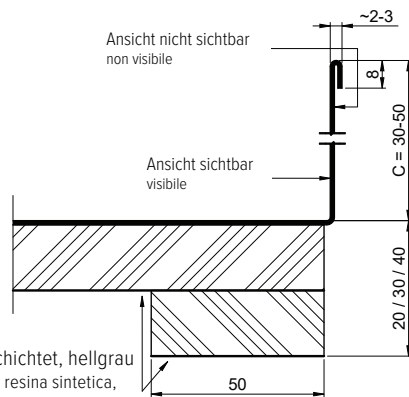

Spanplatte Kunstharz beschichtet, hellgrau
Pannello truciolare rivestito di resina sintetica,
grigio chiaro

Erhältliche Oberflächen / Superfici disponibili

Standard SF BF BX WF

Weitere Produktinformationen / Altre informazioni prodotto 32

i Für Fertigwände mit Silikonabdichtung.
Pour cloisons avec joint silicone.

Nur hinten möglich.
Seitlich nicht geschlossen.
Mehrseitig nicht möglich.

Possibile solo sul retro.
Non chiuso lateralmente.
Non è possibile su più lati.

Schleifrichtungen Varix, s. Seite 49
Direzione di rettifica Varix sulla pag. 49

Standardoberflächen / Superfici standard

SF	Seidenmatt-Finish / Finitura satinata
BF	Breitband-Finish / Finitura a nastro largo
BX	Breitband Varix / Nastro largo Varix
WF	Wirbel-Finish / Finitura a turbino

Decor Oberflächen / Superfici Decor

PS	Polaris Silver
PB	Polaris Black
TR	Terra

Spezialoberflächen / Superfici speciali

ID	IceDesign™	PL	Polar Look	XB	Xrange Black
BI	BlackRange Industrial	XI	Xrange Ice	SL	Silk Look
BP	BlackRange Passion	XF	Xrange Finline	WG	Warmgewalzt Laminazione a caldo

Alle Massangaben in mm
Unità di misura in mm

Zarge C30-D-90° – C170-D-90° / Telaio C30-D-90° – C170-D-90°

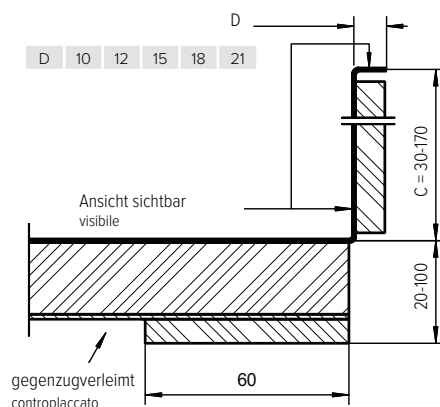

Erhältliche Oberflächen / Superfici disponibili

Standard SF BF WF

Weitere Produktinformationen / Altre informazioni prodotto  32

- i** Für fugenlose Stehborde oder Rückwand.
Mit Holzaufdoppelung, Zargenabschluss
verschweisst auf Wunsch erhältlich.
Per sponde verticali senza giunti o pannello posteriore.
Con riporto in legno. Su richiesta,
disponibilità di chiusura telaio saldata.

Zarge C30-D-90° – C50-D-90° Varix / Telaio C30-D-90° – C50-D-90° Varix

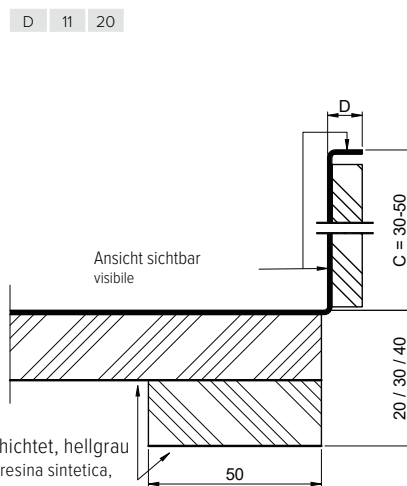

Spanplatte Kunstharz beschichtet, hellgrau
Pannello truciolare rivestito di resina sintetica,
grigio chiaro

Erhältliche Oberflächen / Superfici disponibili

Standard SF BF BX WF

Weitere Produktinformationen / Altre informazioni prodotto  32

- i** Für fugenlose Stehborde oder Rückwand.
Mit Holzaufdoppelung.
Per sponde verticali senza giunti o pannello posteriore.
Con riporto in legno.

Nur hinten möglich.
Seitlich nicht geschlossen.
Mehrseitig nicht möglich.

Possibile solo sul retro.
Non chiuso lateralmente.
Non è possibile su più lati.

Standardoberflächen / Superfici standard

SF	Seidenmatt-Finish / Finitura satinata
BF	Breitband-Finish / Finitura a nastro largo
BX	Breitband Varix / Nastro largo Varix
WF	Wirbel-Finish / Finitura a turbino

Decor Oberflächen / Superfici Decor

PS	Polaris Silver
PB	Polaris Black
TR	Terra

Spezialoberflächen / Superfici speciali

ID	IceDesign™	PL	Polar Look	XB	Xrange Black
BI	BlackRange Industrial	XI	Xrange Ice	SL	Silk Look
BP	BlackRange Passion	XF	Xrange Finline	WG	Warmgewalzt Laminazione a caldo

Alle Massangaben in mm
Unità di misura in mm

Zarge C30-D-90° – C170-D-90° hinten sichtbar / Telaio C30-D-90° – C170-D-90° visibile sul retro

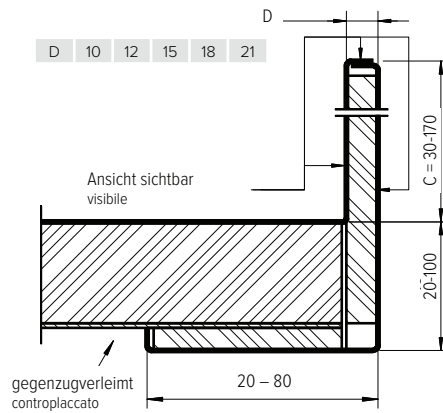

Erhältliche Oberflächen / Superfici disponibili

Standard SF BF WF

Weitere Produktinformationen / Altre informazioni prodotto  32

i Für freistehende Anwendungen. Mit Holzaufdoppelung. Zargenabschluss verschweisst auf Wunsch erhältlich.

Per impieghi a posa libera. Con riporto in legno. Su richiesta, disponibilità di chiusura telaio saldata.

Zarge C30-D-90° – C50-D-90° hinten sichtbar Varix / Telaio C30-D-90° – C50-D-90° visibile sul retro Varix

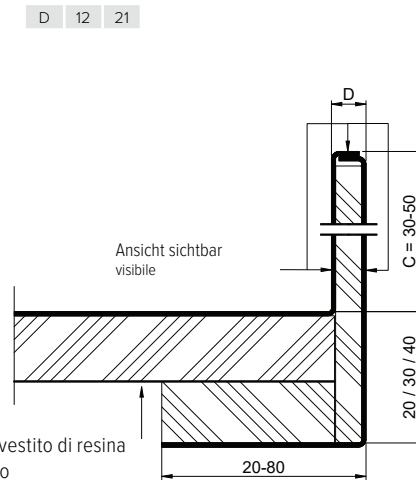

Pannello truciolare rivestito di resina sintetica, grigio chiaro

Erhältliche Oberflächen / Superfici disponibili

Standard SF BF BX WF

Weitere Produktinformationen / Altre informazioni prodotto  32

i Für freistehende Anwendungen. Mit Holzaufdoppelung. Per impieghi a posa libera. Con riporto in legno.

Nur hinten möglich.
Seitlich nicht geschlossen.
Mehrseitig nicht möglich.

Possibile solo sul retro.
Non chiuso lateralmente.
Non è possibile su più lati.

Schleifrichtungen Varix, s. Seite 49
Direzione di rettifica Varix sulla pag. 49

Standardoberflächen / Superfici standard

SF	Seidenmatt-Finish / Finitura satinata
BF	Breitband-Finish / Finitura a nastro largo
BX	Breitband Varix / Nastro largo Varix
WF	Wirbel-Finish / Finitura a turbino

Decor Oberflächen / Superfici Decor

PS	Polaris Silver
PB	Polaris Black
TR	Terra

Spezialoberflächen / Superfici speciali

ID	IceDesign™	PL	Polar Look	XB	Xrange Black
BI	BlackRange Industrial	XI	Xrange Ice	SL	Silk Look
BP	BlackRange Passion	XF	Xrange Finline	WG	Warmgewalzt Laminazione a caldo

Alle Massangaben in mm
Unità di misura in mm

Sickenausführungen / Lavorazioni con nervatura

Sicke 1,5 mm / Nervatura 1,5 mm

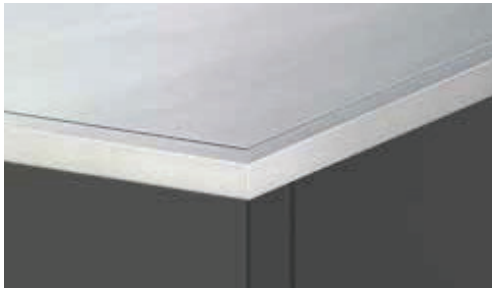

Erhältliche Ausführung / Lavorazione disponibile

SmartSteel Collection



SolidSteel Collection



Weitere Produktinformationen / Altre informazioni prodotto



Erhältliche Oberflächen / Superfici disponibili

Standard

SF

WF

Weitere Produktinformationen / Altre informazioni prodotto



Minimalmasse / Misure minime

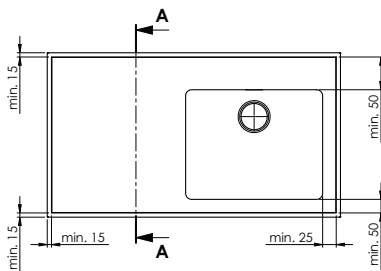

Für Kantenhöhe A12 – A100 ohne Gefälle erhältlich.

L- und U-Winkel Massanfertigungsformen geschweisst oder gesteckt möglich.

Disponibile per altezze di bordo A12 – A100 e senza pendenza.

Possibilità di forme lavorate su misura a «L» e a «U», saldate o ad innesto.

Schnitt A-A / Intaglio A-A

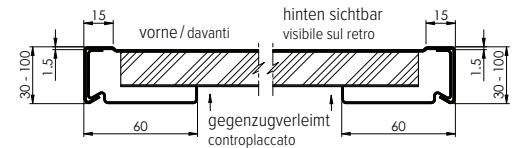
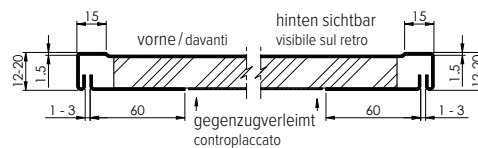

Sicke 10 mm / Nervatura 10 mm

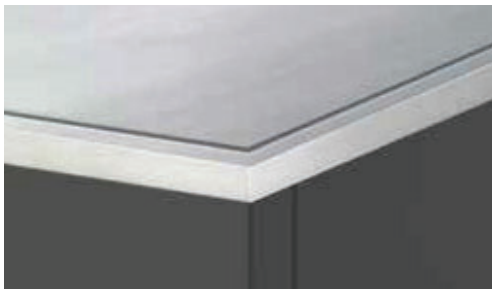

Erhältliche Ausführung / Lavorazione disponibile

SmartSteel Collection



SolidSteel Collection



Weitere Produktinformationen / Altre informazioni prodotto



Erhältliche Oberflächen / Superfici disponibili

Standard

SF

WF

Weitere Produktinformationen / Altre informazioni prodotto



Minimalmasse / Misure minime

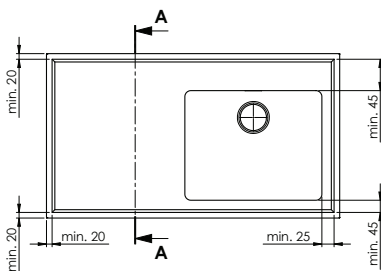

Für Kantenhöhe A20 – A100 ohne Gefälle erhältlich. Nur einzeilige Massanfertigungsformen möglich.

Disponibile per altezze di bordo A20 – A100 senza pendenza. Possibilità di forme lavorate su misura solo su una linea.

Schnitt A-A / Intaglio A-A

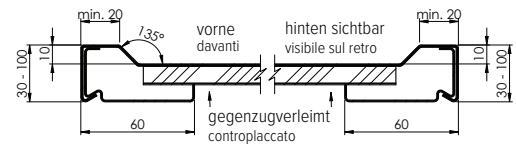
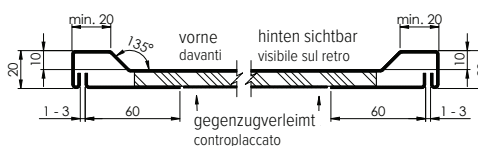

Standardoberflächen / Superfici standard

SF	Seidenmatt-Finish / Finitura satinata
BF	Breitband-Finish / Finitura a nastro largo
BX	Breitband Varix / Nastro largo Varix
WF	Wirbel-Finish / Finitura a turbino

Decor Oberflächen / Superfici Decor

PS	Polaris Silver
PB	Polaris Black
TR	Terra

Spezialoberflächen / Superfici speciali

ID	IceDesign™	PL	Polar Look	XB	Xrange Black
BI	BlackRange Industrial	XI	Xrange Ice	SL	Silk Look
BP	BlackRange Passion	XF	Xrange Finline	WG	Warmgewalzt Laminazione a caldo

Alle Massangaben in mm
Unità di misura in mm

Übersicht Beckeneinbauvarianten / Varianti di montaggio ad incasso del lavello



Einbauvariante Variante di montaggio	Beckenübergang Punto di raccordo lavello	SmartSteel Collection	SolidSteel Collection	Erhältlich für Oberfläche Disponibile per superficie
1 Flächenbündig Filo top	Standard-Fase Smusso standard	✓	–	Standard SF BF BX WF Decor PS PB TR
2 Flächenbündig Filo top	Standard-Fase Smusso standard	–	✓	Standard BF WF Spezial ID BI BP PL XI XF XB SL WG
3 Flächenbündig Filo top	Design-Fase Smusso Design	✓	✓	Standard BF WF
4 Unterbau Sottopiano	Kante mit Fase 1.0/45° Bordo con smusso 1.0/45° 	–	✓	Standard BF WF Spezial ID BI BP PL XI XF XB SL WG

Standardoberflächen / Superfici standard

SF	Seidenmatt-Finish / Finitura satinata
BF	Breitband-Finish / Finitura a nastro largo
BX	Breitband Varix / Nastro largo Varix
WF	Wirbel-Finish / Finitura a turbino

Decor Oberflächen / Superfici Decor

PS	Polaris Silver
PB	Polaris Black
TR	Terra

Spezialoberflächen / Superfici speciali

ID	IceDesign™	PL	Polar Look	XB	Xrange Black
BI	BlackRange Industrial	XI	Xrange Ice	SL	Silk Look
BP	BlackRange Passion	XF	Xrange Finline	WG	Warmgewalzt Laminazione a caldo

Alle Massangaben in mm
Unità di misura in mm

Sortiment nach Unterschrankmassen / Assortimento per dimensioni di base

	35cm	40cm	45cm	50cm	55cm
Linero sFlow, Typ M sFlow, tipo M	 new Linero: LIO 18 	 new Linero: LIO 34 	 new Linero: LIO 40 	 new Linero: LIO 45 	 new Linero: LIO 50 
Daneo sFlow, Typ S sFlow, tipo S	 Daneo: DAN 18 	 Daneo: DAN 34 	 Daneo: DAN 40 	 Daneo: DAN 45 	 Daneo: DAN 50 
Daneo sFlow, Typ M sFlow, tipo M	 Daneo: DAN 18 	 Daneo: DAN 34 	 Daneo: DAN 40 	 Daneo: DAN 45 	 Daneo: DAN 50 
Vantis sFlow, Typ S sFlow, tipo S	 Vantis: V 11 	 Vantis: V 34 	 Vantis: V 40 	 Vantis: V 45 	 Vantis: V 50-42 
Vantis sFlow, Typ M sFlow, tipo M	 Vantis: V 11 	 new Vantis: V 34 	 new Vantis: V 40 	 new Vantis: V 45 	 new Vantis: V 50-42 
Vantis sFlow, Typ S sFlow, tipo S		 new Vantis: VX 34 Varix 	 new Vantis: VX 40 Varix 	 Vantis: VX 45 Varix 	 Vantis: VX 50-42 Varix 
Silver Star sFlow, Typ S sFlow, tipo S	 Silver Star: SIL 9 	 Silver Star: SIL 34 	  Silver Star: SIL 45 	 Silver Star: SIS 50 	
Silver Star sFlow, Typ M sFlow, tipo M	 Silver Star: SIL 18 		 new Silver Star: SX 40 Varix 	 new Silver Star: SX 50-42 Varix 	
Comfort sFlow, Typ S sFlow, tipo S		 Comfort: COM 34 	 Comfort: COM 40 		
Einzel-Becken Lavelli a vasca singola			 Rund: R 44 		

 eFlow mit eControl
eFlow con eControl

 Schwenkbare Überlaufkappe
Placchetta di troppopieno a ribalta

 Desino: Verdeckter Ablauf mit untenliegendem Sieb
Desino: Scarico coperto con griglietta inferiore

55cm

60cm

80cm



Liner: LIO 18 + A 34  76



Liner: LIO 55  78



Daneo: DAN 18 + DAN 34  79



Daneo: DAN 55  83



Daneo: DAN 18 + DAN 34  79



Daneo: DAN 55  83



Vantis: V 50-35  88
Vantis: V 50-35 + V 11



Vantis: V 55  89



Vantis: V 50-35  88
Vantis: V 50-35 + V 11



Vantis: V 55  89



Vantis: VX 55 Varix  91



Silver Star: SIL 50  93
Silver Star: SIL 50 + SIL 9



Silver Star: SIL 18 + SIL 34  92



Silver Star: SIL 55  94



















































Accento: A 65  97

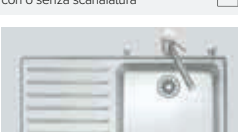



Accento: A 75  97

Sortiment nach Unterschrankmassen / Assortimento per dimensioni di base

	40cm	45cm	50cm	55cm	
Linero sFlow, Typ M sFlow, tipo M			 <p>Starline Pure mit/con: A 50 </p>		
Daneo sFlow, Typ S sFlow, tipo S			 <p>Daneo DAN 100-45 Ambio mit oder ohne Riffel con o senza scanalatura </p>	 <p>Starline Pure mit/con: DAN 45 </p>	 <p>Daneo DAN 100-50 Ambio mit oder ohne Riffel con o senza scanalatura </p>
Daneo sFlow, Typ M sFlow, tipo M			 <p>Daneo DAN 100-45 Ambio mit oder ohne Riffel con o senza scanalatura </p>	 <p>Starline Pure mit/con: DAN 45 </p>	 <p>Daneo DAN 100-50 Ambio mit oder ohne Riffel con o senza scanalatura </p>
Vantis sFlow, Typ S sFlow, tipo S		 <p>Vantis: V 100-40 Classic mit oder ohne Riffel con o senza scanalatura </p>	 <p>Vantis: V 90-45 Classic mit oder ohne Riffel con o senza scanalatura </p>	 <p>Vantis: V 100-45 Classic mit oder ohne Riffel con o senza scanalatura </p>	 <p>Vantis: V 100-50 Classic mit oder ohne Riffel con o senza scanalatura </p>
Vantis sFlow, Typ M sFlow, tipo M		 <p>Vantis: V 100-40 Classic mit oder ohne Riffel con o senza scanalatura </p>	 <p>Vantis: V 90-45 Classic mit oder ohne Riffel con o senza scanalatura </p>	 <p>Vantis: V 100-45 Classic mit oder ohne Riffel con o senza scanalatura </p>	 <p>Vantis: V 100-50 Classic mit oder ohne Riffel con o senza scanalatura </p>
		 <p>Vantis: VX 100-40 Varix Classic mit oder ohne Riffel con o senza scanalatura </p>	 <p>Vantis: VX 90-45 Varix Classic mit oder ohne Riffel con o senza scanalatura </p>	 <p>Vantis: VX 100-45 Varix Classic mit oder ohne Riffel con o senza scanalatura </p>	 <p>Vantis: VX 100-50 Varix Classic mit oder ohne Riffel con o senza scanalatura </p>
Silver Star			 <p>Silver Star: SIL 90-45 Classic mit oder ohne Riffel con o senza scanalatura </p>	 <p>Silver Star: SIL 100-45 Classic mit oder ohne Riffel con o senza scanalatura </p>	 <p>Silver Star: SIS 100-50 Classic mit oder ohne Riffel con o senza scanalatura </p>
Comfort	 <p>Comfort: COM 75 Comfort: COM 90 </p>	 <p>Comfort: COM 100-40 mit oder ohne Riffel con o senza scanalatura </p>			

 eFlow mit eControl
eFlow con eControl

 Schwenkbare Überlaufkappe
Placchetta di troppopieno a ribalta

 Desino: Verdeckter Ablauf mit untenliegendem Sieb
Desino: Scarico coperto con griglietta inferiore

55cm

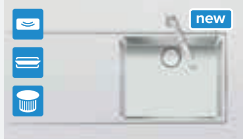

Starline Pure mit/con: A 55 



Starline Pure mit/con: DAN 50 



Starline Pure mit/con: DAN 50 

60cm







Daneo DAN 100-55 Ambio mit oder ohne Riffel con o senza scanalatura 



Starline Pure mit/con: DAN 55 



Daneo DAN 100-55 Ambio mit oder ohne Riffel con o senza scanalatura 



Starline Pure mit/con: DAN 55 



Vantis: V 100-55 Classic mit oder ohne Riffel con o senza scanalatura 



Vantis: V 100-55 Classic mit oder ohne Riffel con o senza scanalatura 



Vantis: VX 100-55 Varix Classic mit oder ohne Riffel con o senza scanalatura 



Silver Star: SIL 100 



Silver Star: SIL 100-55 Classic mit oder ohne Riffel con o senza scanalatura 



Silver Star: SIL 100-18/34 Classic mit oder ohne Riffel con o senza scanalatura 

80cm

90cm



Comfort: COM 135-34 





Comfort: COM 135-40 

Flächenbündig eingeschweisste Becken / Lavelli termosaldato

Linero

Küchenzubehör für Linero siehe / Accessori per cucina per Linero v. 



Modell Modello	Material Materiale	Ventil sFlow, Typ M Piletta sFlow, tipo M	 Advant	 in / in cm
LIO 18*	Edelstahl, matt Acciaio inox, opaco	3 1/2" eFlow Desino	–	◀35▶
		3 1/2" TouchFlow Desino	–	
LIO 34	Edelstahl, matt Acciaio inox, opaco	3 1/2" eFlow Desino	–	◀40▶
		3 1/2" TouchFlow Desino	–	
		3 1/2" Raumspar Desino / Salvaspazio Desino	✓	
LIO 18 + LIO 34	Edelstahl, matt Acciaio inox, opaco	3 1/2" eFlow Desino + eFlow Desino	–	◀60▶
		3 1/2" TouchFlow Desino + TouchFlow Desino	–	

 Für Decor Oberfläche und BX auf Anfrage.
Su richiesta, per superfici Decor e BX.

* Kombination LIO 18 + LIO 34:
Erfordert beidseitigen Ausschnitt der Korpuswand,
bei LIO 18 mit vergrößertem Ausschnitt.
Combinazione LIO 18 + LIO 34:
Richiede un intaglio della parete dell'armadio su
entrambi i lati, per LIO 18 un intaglio allargato.

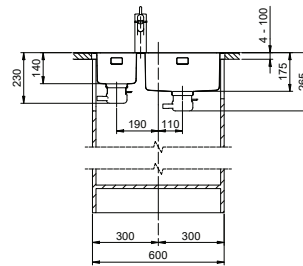
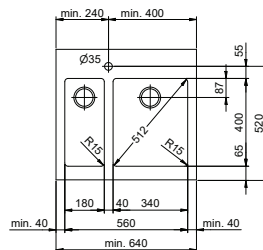



 eFlow mit eControl
eFlow con eControl



Für eFlow Desino
Per eFlow Desino





  Schwenkbare Überlaufkappe
Placchetta di troppopieno a ribalta



Für TouchFlow Desino und Raumspar Desino
Per TouchFlow Desino e Salvaspazio Desino



  Desino: Verdeckter Ablauf mit untenliegendem Sieb
Desino: Scarico coperto con griglietta inferiore





Für eFlow Desino, TouchFlow Desino und Raumspar Desino
Per eFlow Desino, TouchFlow Desino e Salvaspazio Desino





Linero

Küchenzubehör für Linero siehe / Accessori per cucina per Linero v. 

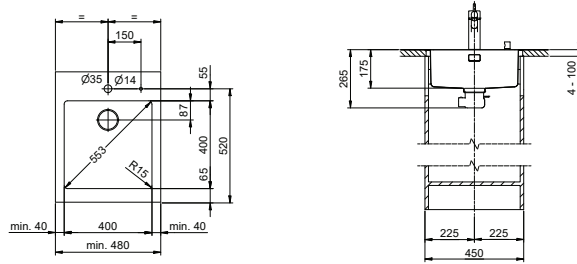

Modell Modello	Material Materiale	Ventil sFlow, Typ M Piletta sFlow, tipo M	 Advant	 in / in cm
LIO 40	Edelstahl, matt Acciaio inox, opaco	3 1/2" eFlow Desino	–	◀45▶
		3 1/2" TouchFlow Desino	–	
		3 1/2" Raumspar Desino / Salvaspazio Desino	✓	



 eFlow mit eControl
eFlow con eControl

 27

 Schwenkbare Überlaufkappe
Placchetta di troppieno a ribalta

 27

 Desino: Verdeckter Ablauf mit untenliegendem Sieb
Desino: Scarico coperto con griglietta inferiore

 26



Für eFlow Desino
Per eFlow Desino





Für TouchFlow Desino und Raumspar Desino
Per TouchFlow Desino e Salvaspazio Desino



Für eFlow Desino, TouchFlow Desino und Raumspar Desino
Per eFlow Desino, TouchFlow Desino e Salvaspazio Desino



Modell Modello	Material Materiale	Ventil sFlow, Typ M Piletta sFlow, tipo M	 Advant	 in / in cm
LIO 45	Edelstahl, matt Acciaio inox, opaco	3 1/2" eFlow Desino	–	◀50▶
		3 1/2" TouchFlow Desino	–	
		3 1/2" Raumspar Desino / Salvaspazio Desino	✓	

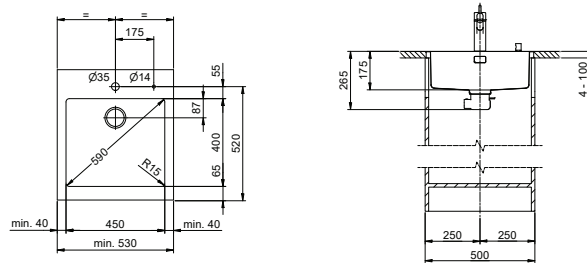

 eFlow mit eControl
eFlow con eControl

 27

 Schwenkbare Überlaufkappe
Placchetta di troppieno a ribalta

 27

 Desino: Verdeckter Ablauf mit untenliegendem Sieb
Desino: Scarico coperto con griglietta inferiore

 26



Für eFlow Desino
Per eFlow Desino





Für TouchFlow Desino und Raumspar Desino
Per TouchFlow Desino e Salvaspazio Desino







Für eFlow Desino, TouchFlow Desino und Raumspar Desino
Per eFlow Desino, TouchFlow Desino e Salvaspazio Desino



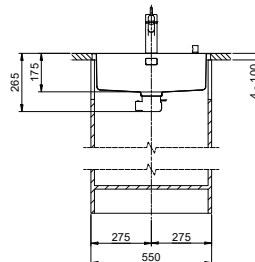
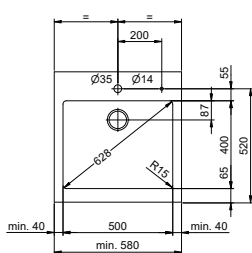

Linero

Küchenzubehör für Linero siehe / Accessori per cucina per Linero v. 

Modell Modello	Material Materiale	Ventil sFlow, Typ M Piletta sFlow, tipo M	 Advant	 in / in cm
LIO 50	Edelstahl, matt Acciaio inox, opaco	3 1/2" eFlow Desino	–	◀55▶
		3 1/2" TouchFlow Desino	–	
		3 1/2" Raumspar Desino / Salvaspazio Desino	✓	

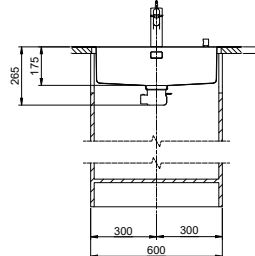
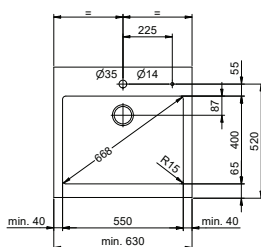
 eFlow mit eControl
eFlow con eControl
Für eFlow Desino
Per eFlow Desino
 Schwenkbare Überlaufkappe
Placchetta di troppopieno a ribalta
Für TouchFlow Desino und Raumspar Desino
Per TouchFlow Desino e Salvaspazio Desino
 Desino: Verdeckter Ablauf mit untenliegendem Sieb
Desino: Scarico coperto con griglietta inferiore
Für eFlow Desino, TouchFlow Desino und Raumspar Desino
Per eFlow Desino, TouchFlow Desino e Salvaspazio Desino

Modell Modello	Material Materiale	Ventil sFlow, Typ M Piletta sFlow, tipo M	 Advant	 in / in cm
LIO 55	Edelstahl, matt Acciaio inox, opaco	3 1/2" eFlow Desino	–	◀60▶
		3 1/2" TouchFlow Desino	–	
		3 1/2" Raumspar Desino / Salvaspazio Desino	✓	



 eFlow mit eControl
eFlow con eControl
Für eFlow Desino
Per eFlow Desino
 Schwenkbare Überlaufkappe
Placchetta di troppopieno a ribalta
Für TouchFlow Desino und Raumspar Desino
Per TouchFlow Desino e Salvaspazio Desino
 Desino: Verdeckter Ablauf mit untenliegendem Sieb
Desino: Scarico coperto con griglietta inferiore
Für eFlow Desino, TouchFlow Desino und Raumspar Desino
Per eFlow Desino, TouchFlow Desino e Salvaspazio Desino



Daneo

Küchenzubehör für Daneo siehe / Accessori per cucina per Daneo v. 



 Schwenkbare Überlaufkappe
Trooppieno coperto con placchetta a ribalta

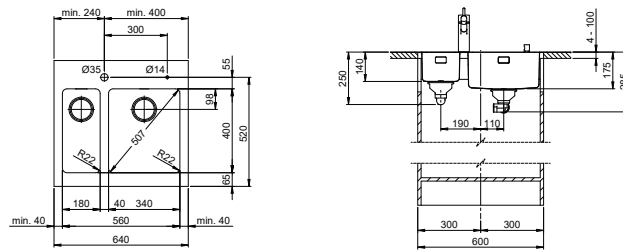

 Für Decor Oberfläche und BX auf Anfrage.
Su richiesta, per superfici Decor e BX.

Modell Modello	Material Materiale	Ventil sFlow, Typ S Piletta sFlow, tipo S	 Advant	 in / in cm
DAN 18*	Edelstahl, matt Acciaio inox, opaco	3 1/2" Tipo	–	◀35▶
DAN 34	Edelstahl, matt Acciaio inox, opaco	3 1/2" TouchFlow	–	◀40▶
		3 1/2" Raumspar / Salvaspazio	✓	
DAN 18 + DAN 34	Edelstahl, matt Acciaio inox, opaco	3 1/2" Tipo	–	◀60▶
		3 1/2" Tipo + TouchFlow	–	
		3 1/2" Tipo + Raumspar / Tipo + Salvaspazio	✓	
		3 1/2" Tipo + Tipo	–	



 Für Decor Oberfläche und BX auf Anfrage.
Su richiesta, per superfici Decor e BX.

* Kombination DAN 18 + DAN 34:
Erfordert beidseitigen Ausschnitt der Korpuswand,
bei DAN 18 mit vergrößertem Ausschnitt.
Combinazione DAN 18 + DAN 34:
Richiede un intaglio della parete dell'armadio su
entrambi i lati, per DAN 18 un intaglio allargato.

Modell Modello	Material Materiale	Ventil sFlow, Typ M Piletta sFlow, tipo M	 Advant	 in / in cm
DAN 18*	Edelstahl, matt Acciaio inox, opaco	3 1/2" eFlow Desino	–	◀35▶
		3 1/2" TouchFlow Desino	–	
DAN 34	Edelstahl, matt Acciaio inox, opaco	3 1/2" eFlow Desino	–	◀40▶
		3 1/2" TouchFlow Desino	–	
		3 1/2" Raumspar Desino / Salvaspazio Desino	✓	
DAN 18 + DAN 34	Edelstahl, matt Acciaio inox, opaco	3 1/2" eFlow Desino + eFlow Desino	–	◀60▶
		3 1/2" TouchFlow Desino + TouchFlow Desino	–	

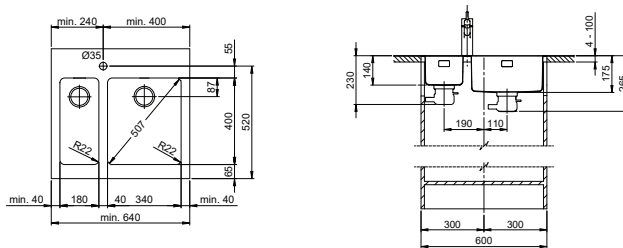

 eFlow mit eControl
eFlow con eControl

 27

 Schwenkbare Überlaufkappe
Placchetta di trooppieno a ribalta

 27

 Desino: Verdeckter Ablauf mit untenliegendem Sieb
Desino: Scarico coperto con griglietta inferiore

 26



Für eFlow Desino
Per eFlow Desino



Für TouchFlow Desino und Raumspar Desino
Per TouchFlow Desino e Salvaspazio Desino



Für eFlow Desino, TouchFlow Desino und Raumspar Desino
Per eFlow Desino, TouchFlow Desino e Salvaspazio Desino



Daneo

Küchenzubehör für Daneo siehe / Accessori per cucina per Daneo v. 

 Schwenkbare Überlaufkappe
Troppopieno coperto con placchetta a ribalta

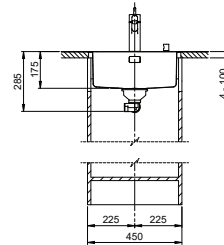
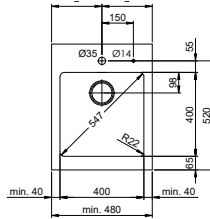
Modell Modello	Material Materiale	Ventil sFlow, Typ S Piletta sFlow, tipo S	 Advant	 in / in cm
DAN 40	Edelstahl, matt Acciaio inox, opaco	3 1/2" TouchFlow	–	◀45▶
		3 1/2" Raumspar / Salvaspazio	✓	
		3 1/2" Tipo	–	



Modell Modello	Material Materiale	Ventil sFlow, Typ M Piletta sFlow, tipo M	 Advant	 in / in cm
DAN 40	Edelstahl, matt Acciaio inox, opaco	3 1/2" eFlow Desino	–	◀45▶
		3 1/2" TouchFlow Desino	–	
		3 1/2" Raumspar Desino / Salvaspazio Desino	✓	

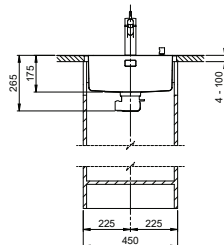
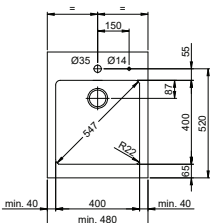

 eFlow mit eControl
eFlow con eControl



Für eFlow Desino
Per eFlow Desino



 Schwenkbare Überlaufkappe
Placchetta di troppopieno a ribalta



Für TouchFlow Desino und Raumspar Desino
Per TouchFlow Desino e Salvaspazio Desino



 Desino: Verdeckter Ablauf mit untenliegendem Sieb
Desino: Scarico coperto con griglietta inferiore



Für eFlow Desino, TouchFlow Desino und Raumspar Desino
Per eFlow Desino, TouchFlow Desino e Salvaspazio Desino





26

Daneo



Küchenzubehör für Daneo siehe/ Accessori per cucina per Daneo v. 



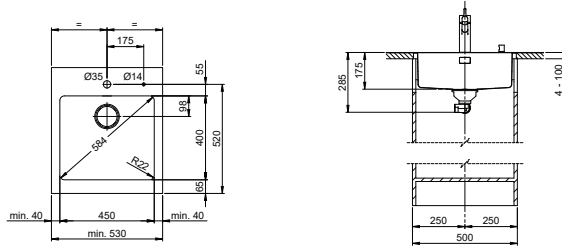

 Schwenkbare Überlaufkappe
Trooppieno coperto con placchetta a ribalta

Modell Modello	Material Materiale	Ventil sFlow, Typ S Piletta sFlow, tipo S	 Advant	 in / in cm
DAN 45	Edelstahl, matt Acciaio inox, opaco	3 1/2" TouchFlow	–	◀50▶
		3 1/2" Raumspar / Salvaspazio	✓	
		3 1/2" Tipo	–	

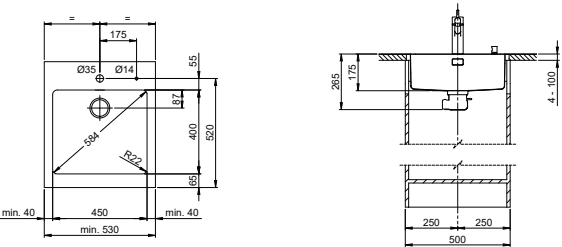

Modell Modello	Material Materiale	Ventil sFlow, Typ M Piletta sFlow, tipo M	 Advant	 in / in cm
DAN 45	Edelstahl, matt Acciaio inox, opaco	3 1/2" eFlow Desino	–	◀50▶
		3 1/2" TouchFlow Desino	–	
		3 1/2" Raumspar Desino / Salvaspazio Desino	✓	



 eFlow mit eControl
eFlow con eControl

 27

 Schwenkbare Überlaufkappe
Placchetta di trooppieno a ribalta

 27

 Desino: Verdeckter Ablauf mit untenliegendem Sieb
Desino: Scarico coperto con griglietta inferiore

 26



Für eFlow Desino
Per eFlow Desino





Für TouchFlow Desino und Raumspar Desino
Per TouchFlow Desino e Salvaspazio Desino



Für eFlow Desino, TouchFlow Desino und Raumspar Desino
Per eFlow Desino, TouchFlow Desino e Salvaspazio Desino



Daneo

Küchenzubehör für Daneo siehe / Accessori per cucina per Daneo v. 

 Schwenkbare Überlaufkappe
Trooppieno coperto con placchetta a ribalta

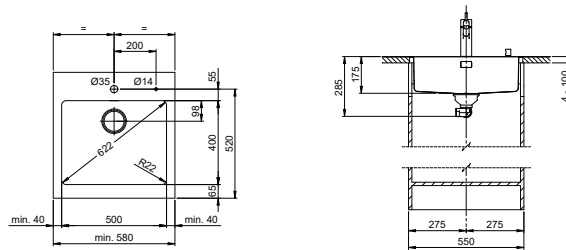
Modell Modello	Material Materiale	Ventil sFlow, Typ S Piletta sFlow, tipo S	 Advant	 in / in cm
DAN 50	Edelstahl, matt Acciaio inox, opaco	3 1/2" TouchFlow	–	◀55▶
		3 1/2" Raumspar / Salvaspazio	✓	
		3 1/2" Tipo	–	



Modell Modello	Material Materiale	Ventil sFlow, Typ M Piletta sFlow, tipo M	 Advant	 in / in cm
DAN 50	Edelstahl, matt Acciaio inox, opaco	3 1/2" eFlow Desino	–	◀55▶
		3 1/2" TouchFlow Desino	–	
		3 1/2" Raumspar Desino / Salvaspazio Desino	✓	

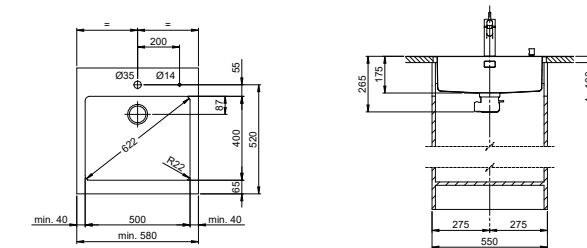

 eFlow mit eControl
eFlow con eControl



Für eFlow Desino
Per eFlow Desino



 Schwenkbare Überlaufkappe
Placchetta di trooppieno a ribalta



Für TouchFlow Desino und Raumspar Desino
Per TouchFlow Desino e Salvaspazio Desino



 Desino: Verdeckter Ablauf mit untenliegendem Sieb
Desino: Scarico coperto con griglietta inferiore



Für eFlow Desino, TouchFlow Desino und Raumspar Desino
Per eFlow Desino, TouchFlow Desino e Salvaspazio Desino





Daneo



Küchenzubehör für Daneo siehe / Accessori per cucina per Daneo v. 



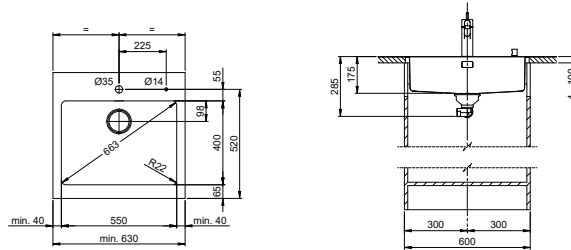

 Schwenkbare Überlaufkappe
Trooppieno coperto con placchetta a ribalta

Modell Modello	Material Materiale	Ventil sFlow, Typ S Piletta sFlow, tipo S	 Advant	 in / in cm
DAN 55	Edelstahl, matt Acciaio inox, opaco	3 1/2" TouchFlow	-	◀60▶
		3 1/2" Raumspar / Salvaspazio	✓	
		3 1/2" Tipo	-	

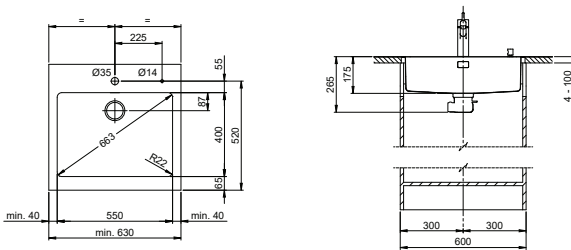

Modell Modello	Material Materiale	Ventil sFlow, Typ M Piletta sFlow, tipo M	 Advant	 in / in cm
DAN 55	Edelstahl, matt Acciaio inox, opaco	3 1/2" eFlow Desino	-	◀60▶
		3 1/2" TouchFlow Desino	-	
		3 1/2" Raumspar Desino / Salvaspazio Desino	✓	



 eFlow mit eControl
eFlow con eControl

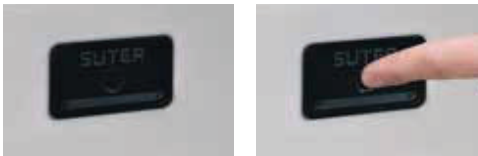

Für eFlow Desino
Per eFlow Desino

 27

 Schwenkbare Überlaufkappe
Placchetta di trooppieno a ribalta



Für TouchFlow Desino und Raumspar Desino
Per TouchFlow Desino e Salvaspazio Desino

 27

 Desino: Verdeckter Ablauf mit untenliegendem Sieb
Desino: Scarico coperto con griglietta inferiore



Für eFlow Desino, TouchFlow Desino und Raumspar Desino
Per eFlow Desino, TouchFlow Desino e Salvaspazio Desino

 26



Vantis

Küchenzubehör für Vantis siehe / Accessori per cucina per Vantis v. 

 Schwenkbare Überlaufkappe
Trooppieno coperto con placchetta a ribalta

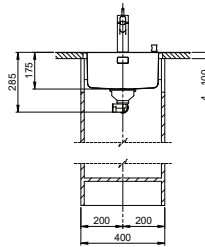
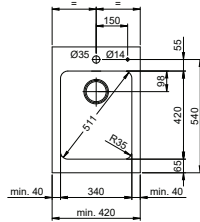
Modell Modello	Material Materiale	Ventil sFlow, Typ S Piletta sFlow, tipo S	 Prime	 in / in cm
V 34	Edelstahl, matt Acciaio inox, opaco	3 1/2" TouchFlow	–	◀40▶
		3 1/2" Raumspar / Salvaspazio	✓	
		3 1/2" Tipo	–	



Modell Modello	Material Materiale	Ventil sFlow, Typ M Piletta sFlow, tipo M	 Advant	 in / in cm
V 34	Edelstahl, matt Acciaio inox, opaco	3 1/2" eFlow Desino	–	◀40▶
		3 1/2" TouchFlow Desino	–	
		3 1/2" Raumspar Desino / Salvaspazio Desino	✓	

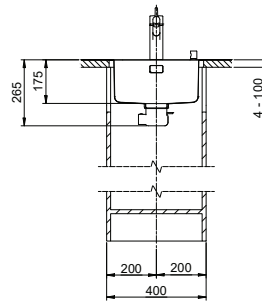
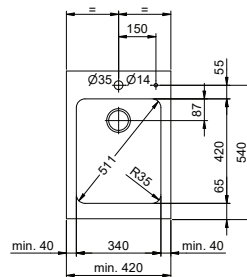

 eFlow mit eControl
eFlow con eControl



 Schwenkbare Überlaufkappe
Placchetta di trooppieno a ribalta



 Desino: Verdeckter Ablauf mit untenliegendem Sieb
Desino: Scarico coperto con griglietta inferiore



Für eFlow Desino
Per eFlow Desino



Für TouchFlow Desino und Raumspar Desino
Per TouchFlow Desino e Salvaspazio Desino





Für eFlow Desino, TouchFlow Desino und Raumspar Desino
Per eFlow Desino, TouchFlow Desino e Salvaspazio Desino

Vantis

Küchenzubehör für Vantis siehe / Accessori per cucina per Vantis v. 



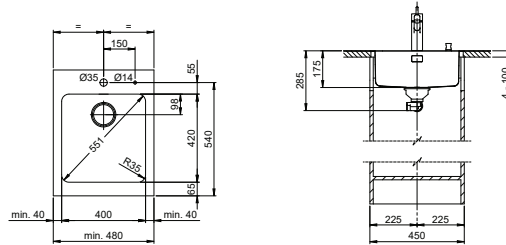

 Schwenkbare Überlaufkappe
Troppopieno coperto con placchetta a ribalta

Modell Modello	Material Materiale	Ventil sFlow, Typ S Piletta sFlow, tipo S	 Prime	 in / in cm
V 40	Edelstahl, matt Acciaio inox, opaco	3 1/2" TouchFlow	–	◀45▶
		3 1/2" Raumspar / Salvaspazio	✓	
		3 1/2" Tipo	–	

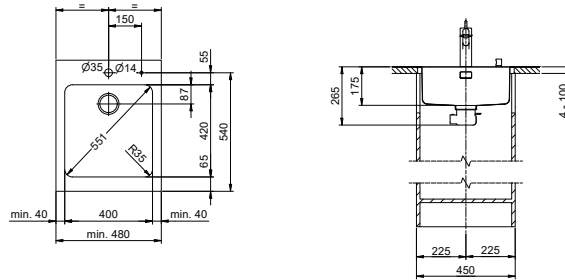

Modell Modello	Material Materiale	Ventil sFlow, Typ M Piletta sFlow, tipo M	 Advant	 in / in cm
V 40	Edelstahl, matt Acciaio inox, opaco	3 1/2" eFlow Desino	–	◀45▶
		3 1/2" TouchFlow Desino	–	
		3 1/2" Raumspar Desino / Salvaspazio Desino	✓	



 eFlow mit eControl
eFlow con eControl



Für eFlow Desino
Per eFlow Desino



 Schwenkbare Überlaufkappe
Placchetta di troppopieno a ribalta



Für TouchFlow Desino und Raumspar Desino
Per TouchFlow Desino e Salvaspazio Desino



 Desino: Verdeckter Ablauf mit untenliegendem Sieb
Desino: Scarico coperto con griglietta inferiore





Für eFlow Desino, TouchFlow Desino und Raumspar Desino
Per eFlow Desino, TouchFlow Desino e Salvaspazio Desino





Vantis

Küchenzubehör für Vantis siehe / Accessori per cucina per Vantis v. 

 Schwenkbare Überlaufkappe
Trotoppieno coperto con placchetta a ribalta

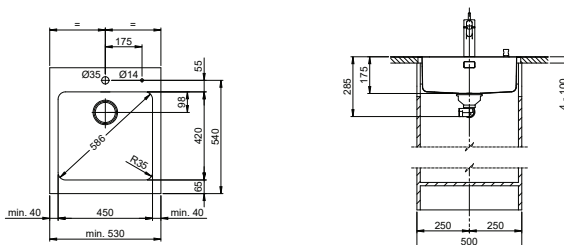
Modell Modello	Material Materiale	Ventil sFlow, Typ S Piletta sFlow, tipo S	 Prime	 in/in cm
V 45	Edelstahl, matt Acciaio inox, opaco	3 1/2" TouchFlow	–	◀50▶
		3 1/2" Raumspar / Salvaspazio	✓	
		3 1/2" Tipo	–	



Modell Modello	Material Materiale	Ventil sFlow, Typ M Piletta sFlow, tipo M	 Advant	 in/in cm
V 45	Edelstahl, matt Acciaio inox, opaco	3 1/2" eFlow Desino	–	◀50▶
		3 1/2" TouchFlow Desino	–	
		3 1/2" Raumspar Desino / Salvaspazio Desino	✓	

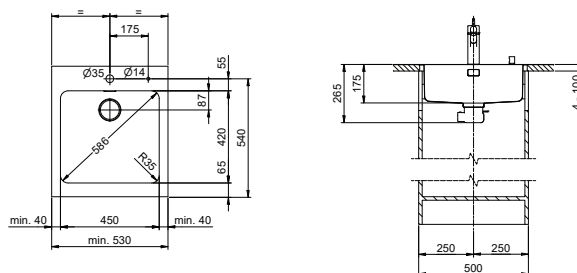

 eFlow mit eControl
eFlow con eControl



Für eFlow Desino
Per eFlow Desino



 Schwenkbare Überlaufkappe
Placchetta di trotoppieno a ribalta



Für TouchFlow Desino und Raumspar Desino
Per TouchFlow Desino e Salvaspazio Desino



 Desino: Verdeckter Ablauf mit untenliegendem Sieb
Desino: Scarico coperto con griglietta inferiore



Für eFlow Desino, TouchFlow Desino und Raumspar Desino
Per eFlow Desino, TouchFlow Desino e Salvaspazio Desino





Vantis



Küchenzubehör für Vantis siehe / Accessori per cucina per Vantis v. 



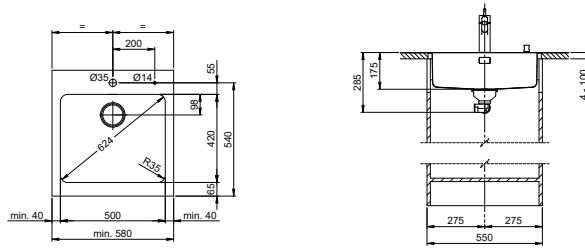

 Schwenkbare Überlaufkappe
Trotopieno coperto con placchetta a ribalta

Modell Modello	Material Materiale	Ventil sFlow, Typ S Piletta sFlow, tipo S	 Prime	 in / in cm
V 50-42	Edelstahl, matt Acciaio inox, opaco	3 1/2" TouchFlow	–	◀55▶
		3 1/2" Raumspar / Salvaspazio	✓	
		3 1/2" Tipo	–	

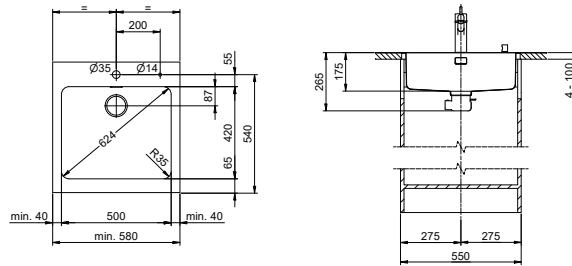

Modell Modello	Material Materiale	Ventil sFlow, Typ M Piletta sFlow, tipo M	 Advant	 in / in cm
V 50-42	Edelstahl, matt Acciaio inox, opaco	3 1/2" eFlow Desino	–	◀55▶
		3 1/2" TouchFlow Desino	–	
		3 1/2" Raumspar Desino / Salvaspazio Desino	✓	



 eFlow mit eControl
eFlow con eControl

 27

 Schwenkbare Überlaufkappe
Placchetta di trotopieno a ribalta

 27

 Desino: Verdeckter Ablauf mit untenliegendem Sieb
Desino: Scarico coperto con griglietta inferiore

 26



Für eFlow Desino
Per eFlow Desino



Für TouchFlow Desino und Raumspar Desino
Per TouchFlow Desino e Salvaspazio Desino



Für eFlow Desino, TouchFlow Desino und Raumspar Desino
Per eFlow Desino, TouchFlow Desino e Salvaspazio Desino

Vantis

Küchenzubehör für Vantis siehe / Accessori per cucina per Vantis v. 



 Schwenkbare Überlaufkappe
Troppopieno coperto con placchetta a ribalta

 Für Decor Oberfläche und BX auf Anfrage.
Su richiesta, per superfici Decor e BX.

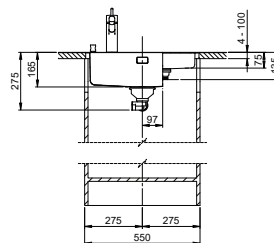
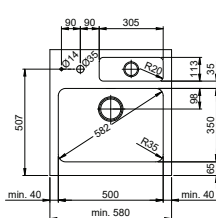
Modell Modello	Material Materiale	Ventil sFlow, Typ S Piletta sFlow, tipo S	 Prime	 in / in cm
V 11	Edelstahl, matt Acciaio inox, opaco	1½" Stopfen / A tappo	–	◀35▶
V 50-35	Edelstahl, matt Acciaio inox, opaco	3½" TouchFlow	–	◀55▶
		3½" Raumspar / Salvaspazio 3½" Tipo	✓	
V 50-35 + V 11	Edelstahl, matt Acciaio inox, opaco	3½" TouchFlow + 1½" Stopfen / A tappo	–	◀55▶
		3½" Raumspar / Salvaspazio + 1½" Stopfen / A tappo	✓	
		3½" Tipo + 1½" Stopfen / A tappo	–	



 Für Decor Oberfläche und BX auf Anfrage.
Su richiesta, per superfici Decor e BX.

Modell Modello	Material Materiale	Ventil sFlow, Typ M Piletta sFlow, tipo M	 Advant	 in / in cm
V 11	Edelstahl, matt Acciaio inox, opaco	1½" Stopfen / A tappo	–	◀35▶
V 50-35	Edelstahl, matt Acciaio inox, opaco	3½" eFlow Desino	–	◀55▶
		3½" TouchFlow Desino 3½" Raumspar Desino / Salvaspazio Desino	✓	
		3½" eFlow Desino + 1½" Stopfen / A tappo	–	
V 50-35 + V 11	Edelstahl, matt Acciaio inox, opaco	3½" TouchFlow Desino + 1½" Stopfen / A tappo	–	◀55▶
		3½" Raumspar Desino / Salvaspazio Desino + 1½" Stopfen / A tappo	✓	

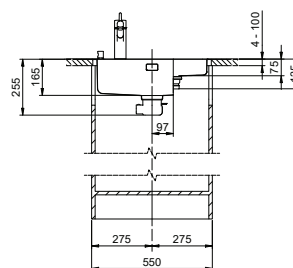
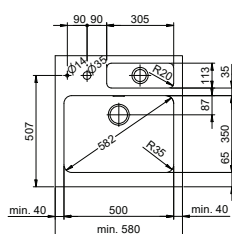

 eFlow mit eControl
eFlow con eControl

27

 Schwenkbare Überlaufkappe
Placchetta di troppopieno a ribalta

27

 Desino: Verdeckter Ablauf mit untenliegendem Sieb
Desino: Scarico coperto con griglietta inferiore

26



Für eFlow Desino
Per eFlow Desino



Für TouchFlow Desino und Raumspar Desino
Per TouchFlow Desino e Salvaspazio Desino



Für eFlow Desino, TouchFlow Desino und Raumspar Desino
Per eFlow Desino, TouchFlow Desino e Salvaspazio Desino





Vantis

Küchenzubehör für Vantis siehe / Accessori per cucina per Vantis v. 



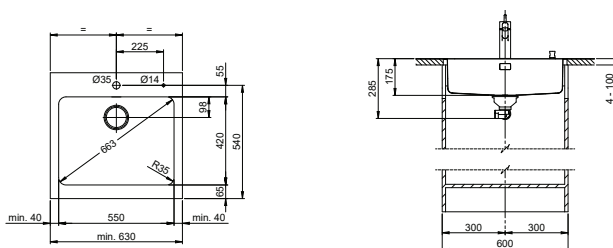

 Schwenkbare Überlaufkappe
Trooppieno coperto con placchetta a ribalta

Modell Modello	Material Materiale	Ventil sFlow, Typ S Piletta sFlow, tipo S	 Prime	 in / in cm
V 55	Edelstahl, matt Acciaio inox, opaco	3 1/2" TouchFlow	–	◀60▶
		3 1/2" Raumspar / Salvaspazio	✓	
		3 1/2" Tipo	–	



new

Modell Modello	Material Materiale	Ventil sFlow, Typ M Piletta sFlow, tipo M	 Advant	 in / in cm
V 55	Edelstahl, matt Acciaio inox, opaco	3 1/2" eFlow Desino	–	◀60▶
		3 1/2" TouchFlow Desino	–	
		3 1/2" Raumspar Desino / Salvaspazio Desino	✓	

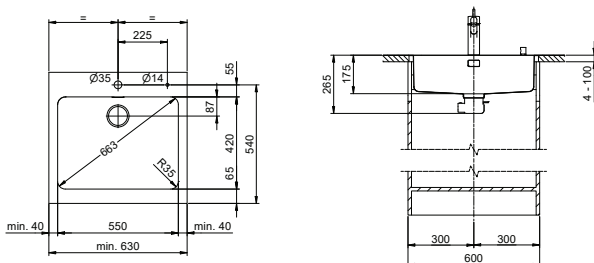

 eFlow mit eControl
eFlow con eControl

 27

 Schwenkbare Überlaufkappe
Placchetta di trooppieno a ribalta

 27

 Desino: Verdeckter Ablauf mit untenliegendem Sieb
Desino: Scarico coperto con griglietta inferiore

 26



Für eFlow Desino
Per eFlow Desino



Für TouchFlow Desino und Raumspar Desino
Per TouchFlow Desino e Salvaspazio Desino



Für eFlow Desino, TouchFlow Desino und Raumspar Desino
Per eFlow Desino, TouchFlow Desino e Salvaspazio Desino

Vantis

Küchenzubehör für Vantis siehe / Accessori per cucina per Vantis v.  310-312

Modell Modello	Material Materiale	Ventil Piletta	 Prime	 in / in cm
VX 34 Varix	Edelstahl, mid-matt	3 1/2" Raumspar / Salvaspazio	✓	◀40▶
	Acciaio inox, mid-matt	3 1/2" Siebstopfen / A tappo c. griglietta	–	

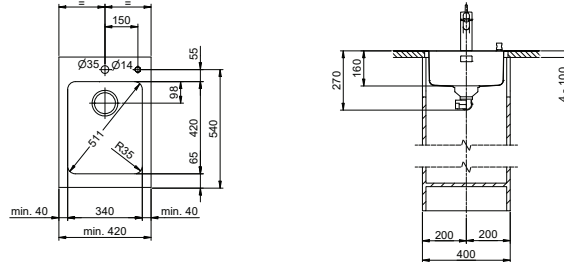

Modell Modello	Material Materiale	Ventil Piletta	 Prime	 in / in cm
VX 40 Varix	Edelstahl, mid-matt	3 1/2" Raumspar / Salvaspazio	✓	◀45▶
	Acciaio inox, mid-matt	3 1/2" Siebstopfen / A tappo c. griglietta	–	

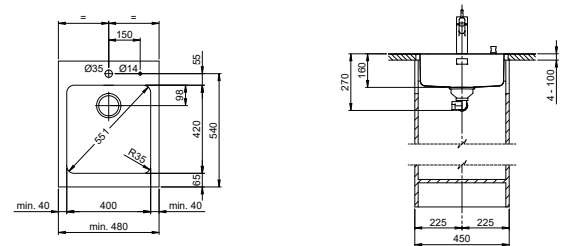

Modell Modello	Material Materiale	Ventil Piletta	 Prime	 in / in cm
VX 45 Varix	Edelstahl, mid-matt	3 1/2" Raumspar / Salvaspazio	✓	◀50▶
	Acciaio inox, mid-matt	3 1/2" Siebstopfen / A tappo c. griglietta	–	

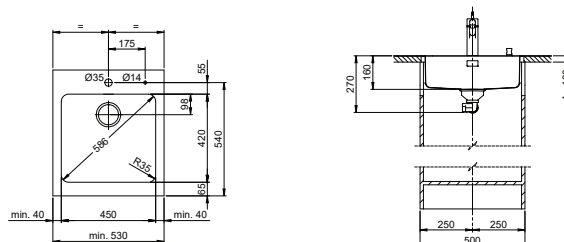

Vantis

Küchenzubehör für Vantis siehe / Accessori per cucina per Vantis v. 310-312



Modell Modello	Material Materiale	Ventil Piletta	Prime	in / in cm
VX 50-42 Varix	Edelstahl, mid-matt Acciaio inox, mid-matt	3 1/2" Raumspar / Salvaspazio	✓	◀55▶
		3 1/2" Siebstopfen / A tappo c. griglietta	–	

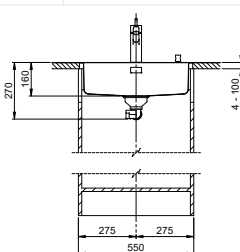
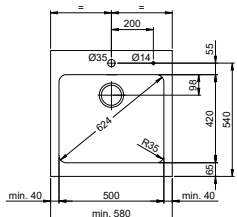

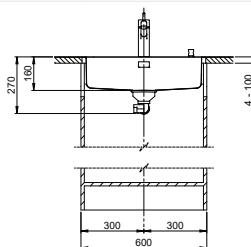
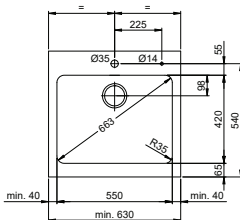

Modell Modello	Material Materiale	Ventil Piletta	Prime	in / in cm
VX 55 Varix	Edelstahl, mid-matt Acciaio inox, mid-matt	3 1/2" Raumspar / Salvaspazio	✓	◀60▶
		3 1/2" Siebstopfen / A tappo c. griglietta	–	







Silver Star

Küchenzubehör für Silver Star siehe / Accessori per cucina per Silver Star v. 

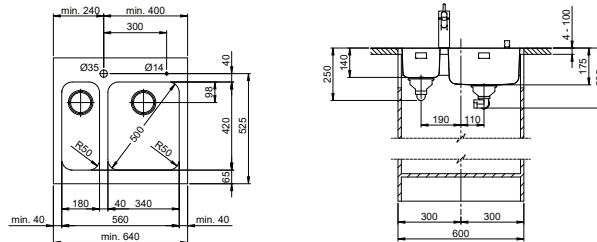
i Für Decor Oberfläche und BX auf Anfrage.
Su richiesta, per superfici Decor e BX.

Modell Modello	Material Materiale	Ventil Piletta	 Prime	 in / in cm
SIL 18	Edelstahl, matt Acciaio inox, opaco	3 1/2" Tipo	–	◀35▶
	Edelstahl, glanz Acciaio inox, lucido	3 1/2" Tipo	–	
SIL 34	Edelstahl, matt Acciaio inox, opaco	3 1/2" Raumspar / Salvaspazio	✓	◀40▶
		3 1/2" Tipo	–	
	Edelstahl, glanz Acciaio inox, lucido	3 1/2" Raumspar / Salvaspazio 3 1/2" Tipo	✓ –	
SIL 18 + SIL 34	Edelstahl, matt Acciaio inox, opaco	3 1/2" Tipo + Raumspar / Tipo + Salvaspazio	✓	◀60▶
		3 1/2" Tipo + Tipo	–	
	Edelstahl, glanz Acciaio inox, lucido	3 1/2" Tipo + Raumspar / Tipo + Salvaspazio 3 1/2" Tipo + Tipo	✓ –	



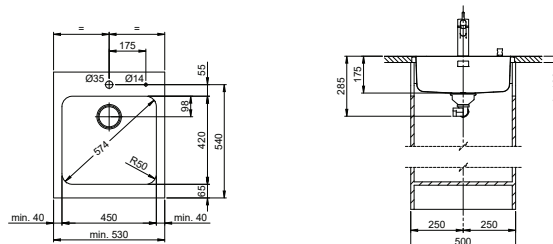

Modell Modello	Material Materiale	Ventil Piletta	 Prime	 in / in cm
SIL 45	Edelstahl, matt Acciaio inox, opaco	3 1/2" Raumspar / Salvaspazio	✓	◀50▶
		3 1/2" Tipo	–	
	Edelstahl, glanz Acciaio inox, lucido	3 1/2" Raumspar / Salvaspazio 3 1/2" Tipo	✓ –	
	Edelstahl, glanz Acciaio inox, lucido	Modell ist mit Überlaufschlitzen und Raumspar-Ventil ausgestattet. Beckentiefe 120 mm. Modello dotato di fessure di troppopieno e piletta salvaspazio. Profondità 120 mm.		◀50▶



Silver Star

Küchenzubehör für Silver Star siehe / Accessori per cucina per Silver Star v. 



Modell Modello	Material Materiale	Ventil Piletta	 Prime	 in / in cm
SIS 50	Edelstahl, matt Acciaio inox, opaco	3 1/2" Raumspar / Salvaspazio	✓	45
		3 1/2" Tipo	-	
	Edelstahl, glanz Acciaio inox, lucido	3 1/2" Raumspar / Salvaspazio	✓	
		3 1/2" Tipo	-	

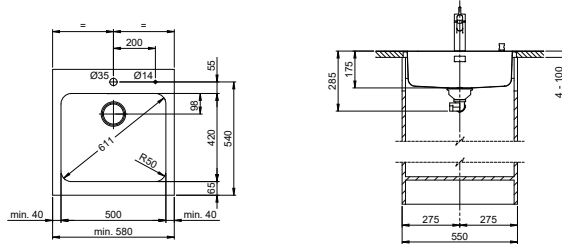

Modell Modello	Material Materiale	Ventil Piletta	 Prime	 in / in cm
SIL 9	Edelstahl, matt Acciaio inox, opaco	1 1/2" Stopfen / A tappo	-	35
		Edelstahl, glanz Acciaio inox, lucido	1 1/2" Stopfen / A tappo	
SIL 50	Edelstahl, matt Acciaio inox, opaco	3 1/2" Raumspar / Salvaspazio	✓	45
		3 1/2" Tipo	-	
	Edelstahl, glanz Acciaio inox, lucido	3 1/2" Raumspar / Salvaspazio	✓	
		3 1/2" Tipo	-	
SIL 50 + SIL 9	Edelstahl, matt Acciaio inox, opaco	3 1/2" Raumspar / Salvaspazio + 1 1/2" Stopfen / A tappo	✓	45
		3 1/2" Tipo + 1 1/2" Stopfen / A tappo	-	
	Edelstahl, glanz Acciaio inox, lucido	3 1/2" Raumspar / Salvaspazio + 1 1/2" Stopfen / A tappo	✓	
		3 1/2" Tipo + 1 1/2" Stopfen / A tappo	-	

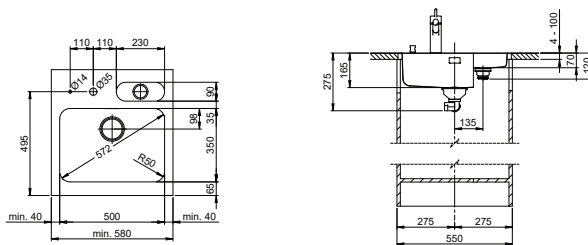

 Für Decor Oberfläche und BX auf Anfrage.
Su richiesta, per superfici Decor e BX.

Silver Star

Küchenzubehör für Silver Star siehe / Accessori per cucina per Silver Star v. 

Modell Modello	Material Materiale	Ventil Piletta	 Prime	 in / in cm
SIL 55	Edelstahl, matt Acciaio inox, opaco	3 1/2" Raumspar / Salvaspazio	✓	◀60▶
		3 1/2" Tipo	–	
	Edelstahl, glanz Acciaio inox, lucido	3 1/2" Raumspar / Salvaspazio	✓	
		3 1/2" Tipo	–	

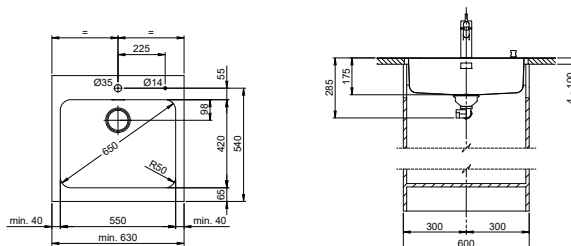

new

Modell Modello	Material Materiale	Ventil Piletta	 Prime	 in / in cm
SX 40 Varix	Edelstahl, mid-matt Eco Acciaio inox, mid-matt Eco	3 1/2" Raumspar / Salvaspazio	✓	◀45▶
		3 1/2" Siebstopfen / A tappo c. griglietta	–	

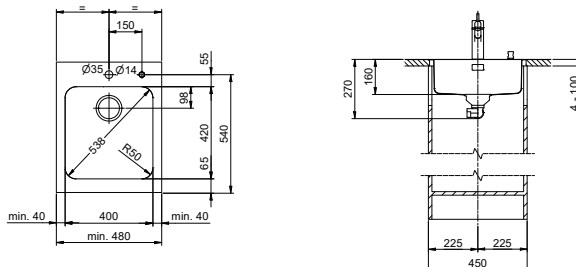

new

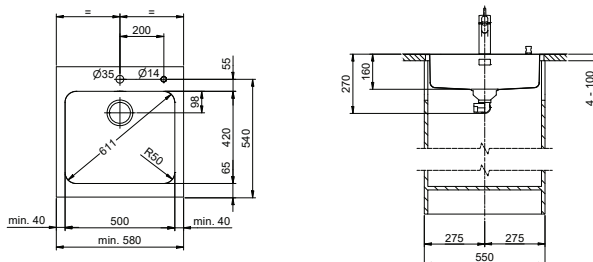

Modell Modello	Material Materiale	Ventil Piletta	 Prime	 in / in cm
SX 50-42 Varix	Edelstahl, mid-matt Eco Acciaio inox, mid-matt Eco	3 1/2" Raumspar / Salvaspazio	✓	◀55▶
		3 1/2" Siebstopfen / A tappo c. griglietta	–	





Comfort

Küchenzubehör für Comfort siehe / Accessori per cucina per Comfort v. 

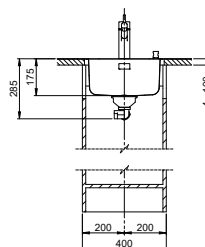
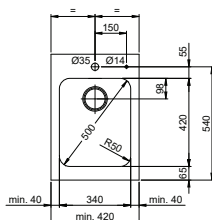

Modell Modello	Material Materiale	Ventil Piletta	 Prime	 in / in cm
COM 34	Edelstahl, glanz Acciaio inox, lucido	3 1/2" Raumspar / Salvaspazio	✓	◀40▶
		3 1/2" Tipo	-	
		1 1/2" Standrohr / Con tubo	-	



Modell Modello	Material Materiale	Ventil Piletta	 Prime	 in / in cm
COM 40	Edelstahl, glanz Acciaio inox, lucido	3 1/2" Raumspar / Salvaspazio	✓	◀45▶
		3 1/2" Tipo	-	

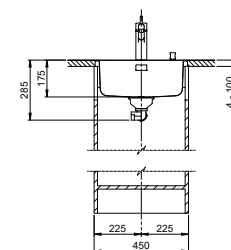
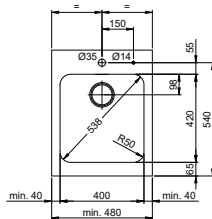

Gastro MaXX

Küchenzubehör für Gastro MaXX siehe / Accessori per cucina per Gastro MaXX v. 

i Für Decor Oberfläche und BX auf Anfrage.
Su richiesta, per superfici Decor e BX.

Modell Modello	Material Materiale	Ventil Piletta	 Advant	 in / in cm
MGM 1	Edelstahl, glanz Acciaio inox, lucido	3 1/2" Raumspar / Salvaspazio	✓	«XX»
		3 1/2" Siebstopfen / A tappo c. griglietta	–	

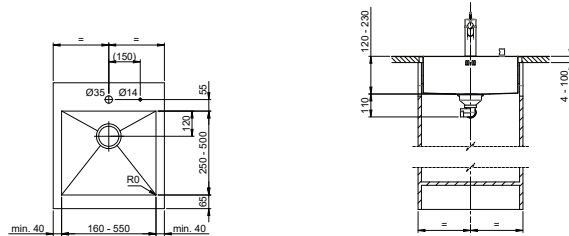

Individuelle Beckengröße möglich
Dimensioni di lavello personalizzabili



i Für Decor Oberfläche und BX auf Anfrage.
Su richiesta, per superfici Decor e BX.

Modell Modello	Material Materiale	Ventil Piletta	 Advant	 in / in cm
MGM 2	Edelstahl, glanz Acciaio inox, lucido	3 1/2" Raumspar / Salvaspazio	✓	«XX»
		3 1/2" Siebstopfen / A tappo c. griglietta	–	

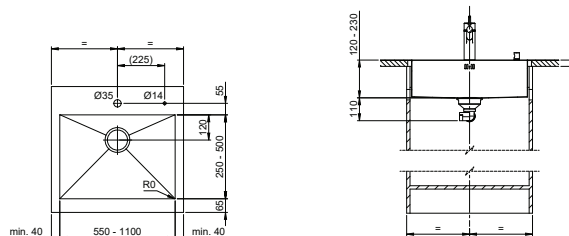

Individuelle Beckengröße möglich
Dimensioni di lavello personalizzabili

Rund



i Für Decor Oberfläche und BX auf Anfrage.
Su richiesta, per superfici Decor e BX.

Modell Modello	Material Materiale	Ventil Piletta	 Prime	 in / in cm
R 44	Edelstahl, glanz Acciaio inox, lucido	3 1/2" Raumspar / Salvaspazio	✓	«45»
		3 1/2" Tipo	–	

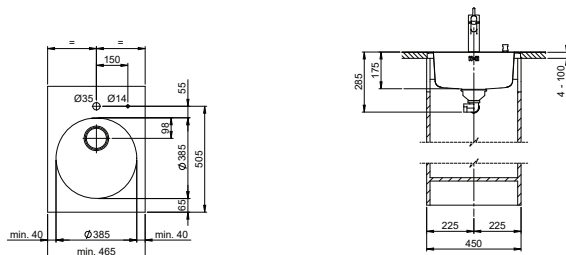



Accento

Küchenzubehör für Accento siehe / Accessori per cucina per Accento v.  310-312



 Schwenkbare Überlaufkappe
Tropspioeno coperto con placchetta a ribalta

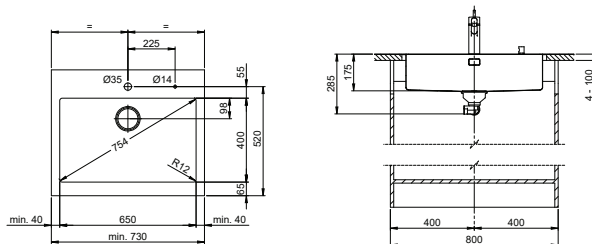

 Für Decor Oberfläche und BX auf Anfrage.
Su richiesta, per superfici Decor e BX.

Modell Modello	Material Materiale	Ventil Piletta	 Advant	 in / in cm
A 65	Edelstahl, glanz Acciaio inox, lucido	3 1/2" TouchFlow	–	◀80▶
		3 1/2" Raumspar / Salvaspazio	✓	
		3 1/2" Tipo	–	



 Schwenkbare Überlaufkappe
Tropspioeno coperto con placchetta a ribalta

 Für Decor Oberfläche und BX auf Anfrage.
Su richiesta, per superfici Decor e BX.

Modell Modello	Material Materiale	Ventil Piletta	 Advant	 in / in cm
A 75	Edelstahl, glanz Acciaio inox, lucido	3 1/2" TouchFlow	–	◀80▶
		3 1/2" Raumspar / Salvaspazio	✓	
		3 1/2" Tipo	–	

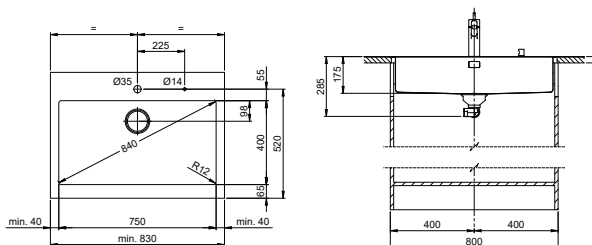

Spüleneinpressungen / Lavelli prestampati

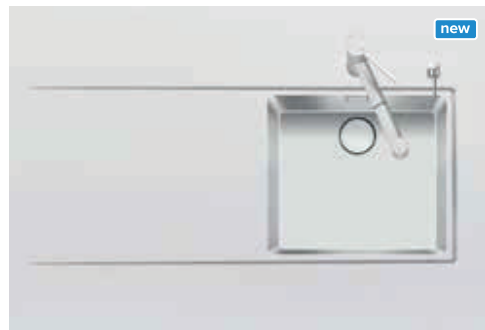

Starline Pure

Küchenzubehör ab Seite / Accessori a partire dalla pagina 309



i Version Tropfteil links oder rechts erhältlich. Erhältlich für SmartSteel Collection in folgenden Oberflächen:
Scolatoio disponibile in versione per posizionamento a sinistra o a destra. Disponibile per SmartSteel Collection nelle seguenti finiture:

Standard SF BF WF

Modell Modello	Material Materiale	Ventil sFlow, Typ M Piletta sFlow, tipo M	 Advant	 in / in cm
Linero LIO 45	Edelstahl, matt Acciaio inox, opaco	3 1/2" eFlow Desino	—	◀50▶
		3 1/2" TouchFlow Desino	—	
		3 1/2" Raumspar Desino / Salvaspazio Desino	✓	

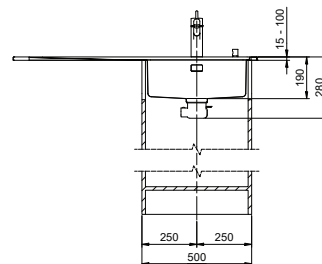
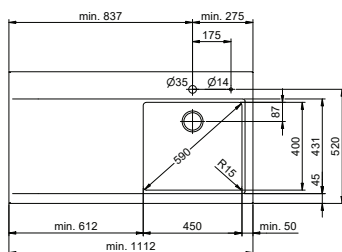

 eFlow mit eControl
eFlow con eControl



Für eFlow Desino
Per eFlow Desino

 Schwenkbare Überlaufkappe
Placchetta di troppopieno a ribalta



Für TouchFlow Desino und Raumspar Desino
Per TouchFlow Desino e Salvaspazio Desino

 Desino: Verdeckter Ablauf mit untenliegendem Sieb
Desino: Scarico coperto con griglietta inferiore



Für eFlow Desino, TouchFlow Desino und Raumspar Desino
Per eFlow Desino, TouchFlow Desino e Salvaspazio Desino

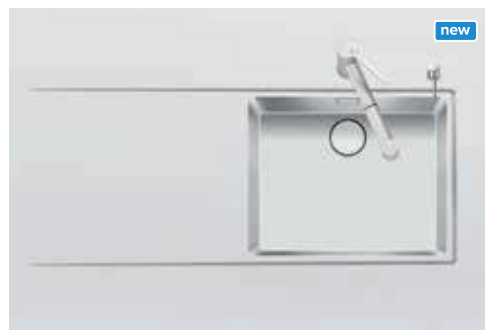

Starline Pure

Küchenzubehör ab Seite / Accessori a partire dalla pagina 309



i Version Tropfteil links oder rechts erhältlich. Erhältlich für SmartSteel Collection in folgenden Oberflächen:
Scolatoio disponibile in versione per posizionamento a sinistra o a destra. Disponibile per SmartSteel Collection nelle seguenti finiture:

Standard SF BF WF

Modell Modello	Material Materiale	Ventil sFlow, Typ M Piletta sFlow, tipo M	 Advant	 in / in cm
Linero LIO 50	Edelstahl, matt Acciaio inox, opaco	3 1/2" eFlow Desino	—	◀55▶
		3 1/2" TouchFlow Desino	—	
		3 1/2" Raumspar Desino / Salvaspazio Desino	✓	

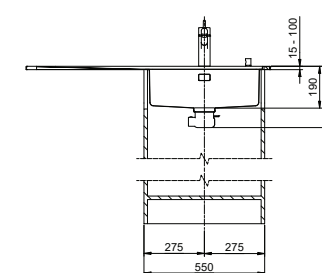
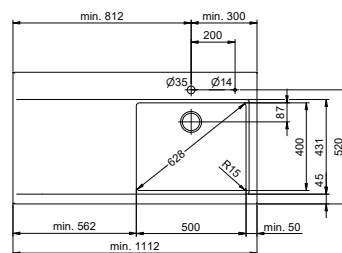

 eFlow mit eControl
eFlow con eControl



Für eFlow Desino
Per eFlow Desino

 Schwenkbare Überlaufkappe
Placchetta di troppopieno a ribalta



Für TouchFlow Desino und Raumspar Desino
Per TouchFlow Desino e Salvaspazio Desino

 Desino: Verdeckter Ablauf mit untenliegendem Sieb
Desino: Scarico coperto con griglietta inferiore



Für eFlow Desino, TouchFlow Desino und Raumspar Desino
Per eFlow Desino, TouchFlow Desino e Salvaspazio Desino

Starline Pure

Küchenzubehör ab Seite / Accessori a partire dalla pagina 309



i Version Tropfteil links oder rechts erhältlich. Erhältlich für SmartSteel Collection in folgenden Oberflächen:
Scolatoio disponibile in versione per posizionamento a sinistra o a destra. Disponibile per SmartSteel Collection nelle seguenti finiture:

Standard SF BF WF

Modell Modello	Material Materiale	Ventil sFlow, Typ M Piletta sFlow, tipo M	Advant	in / in cm
Linero LIO 55	Edelstahl, matt Acciaio inox, opaco	3 1/2" eFlow Desino	-	◀60▶
		3 1/2" TouchFlow Desino	-	
		3 1/2" Raumspar Desino / Salvaspazio Desino	✓	

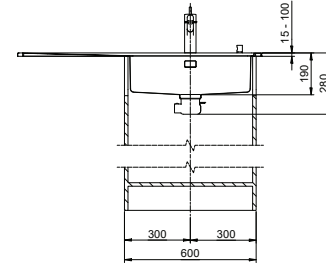
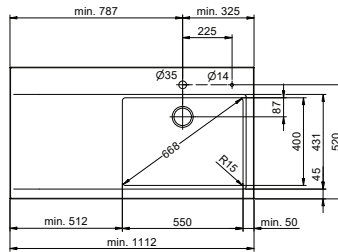

8 eFlow mit eControl
eFlow con eControl



Für eFlow Desino
Per eFlow Desino

27 Schwenkbare Überlaufkappe
Placchetta di troppopieno a ribalta



Für TouchFlow Desino und Raumspar Desino
Per TouchFlow Desino e Salvaspazio Desino

27 Desino: Verdeckter Ablauf mit untenliegendem Sieb
Desino: Scarico coperto con griglietta inferiore



Für eFlow Desino, TouchFlow Desino und Raumspar Desino
Per eFlow Desino, TouchFlow Desino e Salvaspazio Desino

Standardoberflächen / Superfici standard

SF	Seidenmatt-Finish / Finitura satinata
BF	Breitband-Finish / Finitura a nastro largo
BX	Breitband Varix / Nastro largo Varix
WF	Wirbel-Finish / Finitura a turbino

Decor Oberflächen / Superfici Decor

PS	Polaris Silver
PB	Polaris Black
TR	Terra

Spezialoberflächen / Superfici speciali

ID	IceDesign™	PL	Polar Look	XB	Xrange Black
BI	BlackRange Industrial	XI	Xrange Ice	SL	Silk Look
BP	BlackRange Passion	XF	Xrange Finline	WG	Warmgewalzt Laminazione a caldo

Alle Massangaben in mm
Unità di misura in mm

Starline Pure

Küchenzubehör ab Seite / Accessori a partire dalla pagina 309

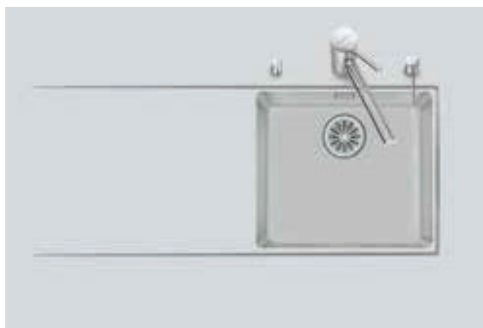

Schwenkbare Überlaufkappe
Trotopieno coperto con placchetta a ribalta

Version Tropfteil links oder rechts erhältlich. Erhältlich für SmartSteel Collection in folgenden Oberflächen:
Scolatoio disponibile in versione per posizionamento a sinistra o a destra. Disponibile per SmartSteel Collection nelle seguenti finiture:

Standard SF BF WF

Modell Modello	Material Materiale	Ventil sFlow, Typ S Piletta sFlow, tipo S	Advant	in / in cm
Daneo DAN 45	Edelstahl, matt Acciaio inox, opaco	3 1/2" TouchFlow	–	450
		3 1/2" Raumspar / Salvaspazio	✓	
		3 1/2" Tipo	–	

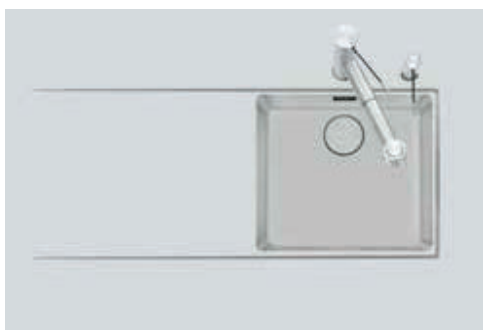
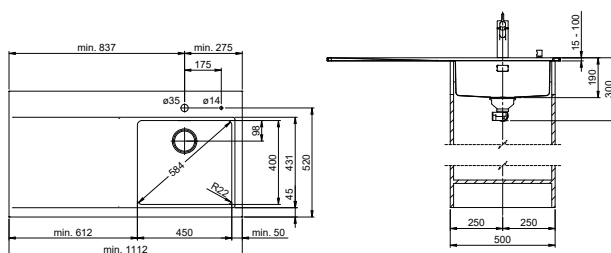

Version Tropfteil links oder rechts erhältlich. Erhältlich für SmartSteel Collection in folgenden Oberflächen:
Scolatoio disponibile in versione per posizionamento a sinistra o a destra. Disponibile per SmartSteel Collection nelle seguenti finiture:

Standard SF BF WF

Modell Modello	Material Materiale	Ventil sFlow, Typ M Piletta sFlow, tipo M	Advant	in / in cm
Daneo DAN 45	Edelstahl, matt Acciaio inox, opaco	3 1/2" eFlow Desino	–	450
		3 1/2" TouchFlow Desino	–	
		3 1/2" Raumspar Desino / Salvaspazio Desino	✓	

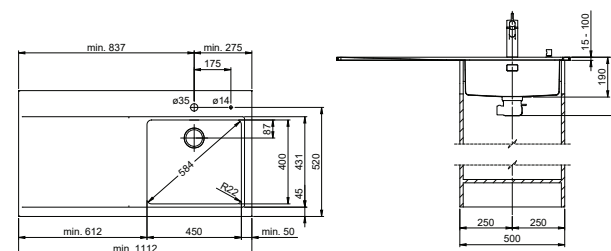

eFlow mit eControl
eFlow con eControl



Für eFlow Desino
Per eFlow Desino

Schwenkbare Überlaufkappe
Placchetta di trotopieno a ribalta



Für TouchFlow Desino und Raumspar Desino
Per TouchFlow Desino e Salvaspazio Desino

Desino: Verdeckter Ablauf mit untenliegendem Sieb
Desino: Scarico coperto con griglietta inferiore



Für eFlow Desino, TouchFlow Desino und Raumspar Desino
Per eFlow Desino, TouchFlow Desino e Salvaspazio Desino

Standardoberflächen / Superfici standard

SF	Seidenmatt-Finish / Finitura satinata
BF	Breitband-Finish / Finitura a nastro largo
BX	Breitband Varix / Nastro largo Varix
WF	Wirbel-Finish / Finitura a turbino

Decor Oberflächen / Superfici Decor

PS	Polaris Silver
PB	Polaris Black
TR	Terra

Spezialoberflächen / Superfici speciali

ID	IceDesign™	PL	Polar Look	XB	Xrange Black
BI	BlackRange Industrial	XI	Xrange Ice	SL	Silk Look
BP	BlackRange Passion	XF	Xrange Finline	WG	Warmgewalzt Laminazione a caldo

Alle Massangaben in mm
Unità di misura in mm

Starline Pure

Küchenzubehör ab Seite / Accessori a partire dalla pagina 309



Schwenkbare Überlaufkappe
Trotoppieno coperto con placchetta a ribalta

i Version Tropfteil links oder rechts erhältlich. Erhältlich für SmartSteel Collection in folgenden Oberflächen:
Scolatoio disponibile in versione per posizionamento a sinistra o a destra. Disponibile per SmartSteel Collection nelle seguenti finiture:

Standard **SF** **BF** **WF**

Modell Modello	Material Materiale	Ventil sFlow, Typ S Piletta sFlow, tipo S	Advant	in / en cm
Daneo DAN 50	Edelstahl, matt Acciaio inox, opaco	3 1/2" TouchFlow	–	◀55▶
		3 1/2" Raumspar / Salvaspazio	✓	
		3 1/2" Tipo	–	

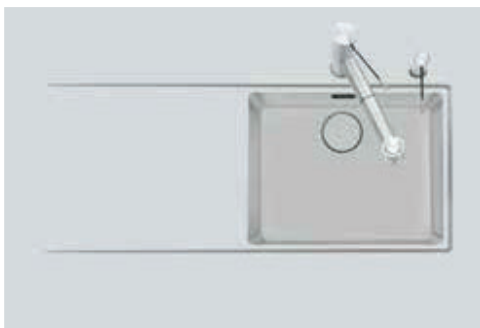
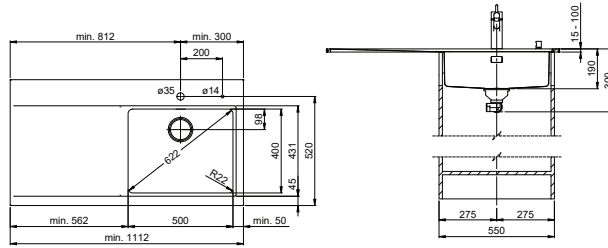

i Version Tropfteil links oder rechts erhältlich. Erhältlich für SmartSteel Collection in folgenden Oberflächen:
Scolatoio disponibile in versione per posizionamento a sinistra o a destra. Disponibile per SmartSteel Collection nelle seguenti finiture:

Standard **SF** **BF** **WF**

Modell Modello	Material Materiale	Ventil sFlow, Typ M Piletta sFlow, tipo M	Advant	in / en cm
Daneo DAN 50	Edelstahl, matt Acciaio inox, opaco	3 1/2" eFlow Desino	–	◀55▶
		3 1/2" TouchFlow Desino	–	
		3 1/2" Raumspar Desino / Salvaspazio Desino	✓	

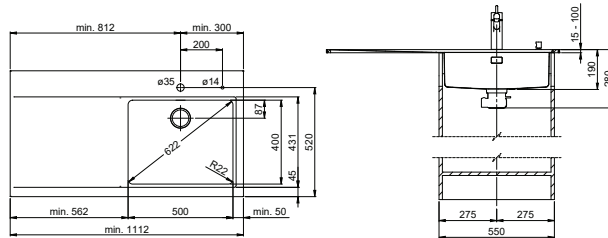

eFlow mit eControl
eFlow con eControl



Für eFlow Desino
Per eFlow Desino

Schwenkbare Überlaufkappe
Placchetta di trotoppieno a ribalta



Für TouchFlow Desino und Raumspar Desino
Per TouchFlow Desino e Salvaspazio Desino

Desino: Verdeckter Ablauf mit untenliegendem Sieb
Desino: Scarico coperto con griglietta inferiore



Für eFlow Desino, TouchFlow Desino und Raumspar Desino
Per eFlow Desino, TouchFlow Desino e Salvaspazio Desino

Standardoberflächen / Superfici standard

SF	Seidenmatt-Finish / Finitura satinata
BF	Breitband-Finish / Finitura a nastro largo
BX	Breitband Varix / Nastro largo Varix
WF	Wirbel-Finish / Finitura a turbino

Decor Oberflächen / Superfici Decor

PS	Polaris Silver
PB	Polaris Black
TR	Terra

Spezialoberflächen / Superfici speciali

ID	IceDesign™	PL	Polar Look	XB	Xrange Black
BI	BlackRange Industrial	XI	Xrange Ice	SL	Silk Look
BP	BlackRange Passion	XF	Xrange Finline	WG	Warmgewalzt Laminazione a caldo

Alle Massangaben in mm
Unità di misura in mm

Starline Pure

Küchenzubehör ab Seite / Accessori a partire dalla pagina 309

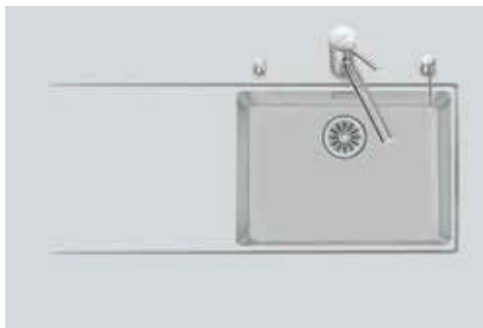

Schwenkbare Überlaufkappe
Troppieno coperto con placchetta a ribalta

i Version Tropfteil links oder rechts erhältlich. Erhältlich für SmartSteel Collection in folgenden Oberflächen:
Scolatoio disponibile in versione per posizionamento a sinistra o a destra. Disponibile per SmartSteel Collection nelle seguenti finiture:

Standard SF BF WF

Modell Modello	Material Materiale	Ventil sFlow, Typ S Piletta sFlow, tipo S	Advant	in / en cm
Daneo DAN 55	Edelstahl, matt Acciaio inox, opaco	3 1/2" TouchFlow	-	◀60▶
		3 1/2" Raumspar / Salvaspazio	✓	
		3 1/2" Tipo	-	

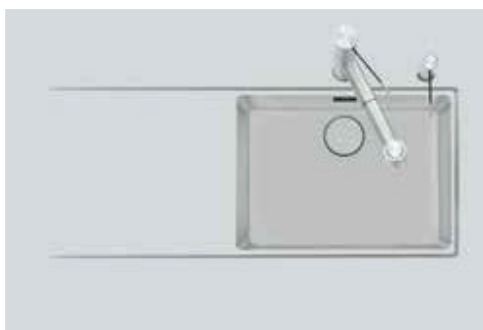
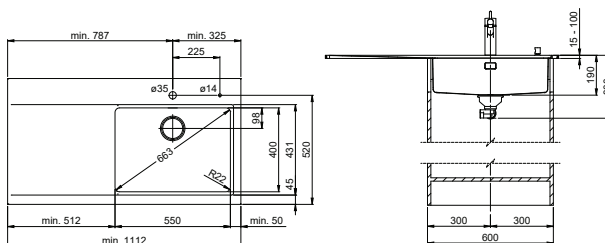

i Version Tropfteil links oder rechts erhältlich. Erhältlich für SmartSteel Collection in folgenden Oberflächen:
Scolatoio disponibile in versione per posizionamento a sinistra o a destra. Disponibile per SmartSteel Collection nelle seguenti finiture:

Standard SF BF WF

Modell Modello	Material Materiale	Ventil sFlow, Typ M Piletta sFlow, tipo M	Advant	in / en cm
Daneo DAN 55	Edelstahl, matt Acciaio inox, opaco	3 1/2" eFlow Desino	-	◀60▶
		3 1/2" TouchFlow Desino	-	
		3 1/2" Raumspar Desino / Salvaspazio Desino	✓	

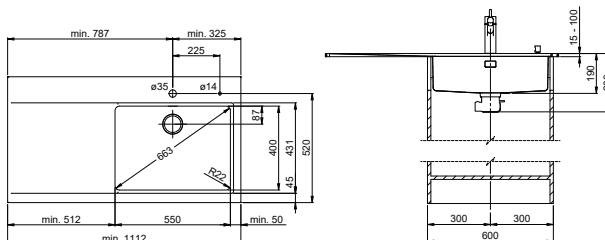

eFlow mit eControl
eFlow con eControl



Für eFlow Desino
Per eFlow Desino

Schwenkbare Überlaufkappe
Placchetta di troppieno a ribalta



Für TouchFlow Desino und Raumspar Desino
Per TouchFlow Desino e Salvaspazio Desino

Desino: Verdeckter Ablauf mit untenliegendem Sieb
Desino: Scarico coperto con griglietta inferiore



Für eFlow Desino, TouchFlow Desino und Raumspar Desino
Per eFlow Desino, TouchFlow Desino e Salvaspazio Desino

Standardoberflächen / Superfici standard

SF	Seidenmatt-Finish / Finitura satinata
BF	Breitband-Finish / Finitura a nastro largo
BX	Breitband Varix / Nastro largo Varix
WF	Wirbel-Finish / Finitura a turbino

Decor Oberflächen / Superfici Decor

PS	Polaris Silver
PB	Polaris Black
TR	Terra

Spezialoberflächen / Superfici speciali



ID	IceDesign™	PL	Polar Look	XB	Xrange Black
BI	BlackRange Industrial	XI	Xrange Ice	SL	Silk Look
BP	BlackRange Passion	XF	Xrange Finline	WG	Warmgewalzt Laminazione a caldo

Alle Massangaben in mm
Unità di misura in mm

Ambio

Küchenzubehör ab Seite / Accessori a partire dalla pagina 309



Modell Modello	Material Materiale	Ventil sFlow, Typ S Piletta sFlow, tipo S	 Advant	 in / in cm
Daneo DAN 100-45 EL Ambio	Edelstahl, matt Acciaio inox, opaco	3 1/2" TouchFlow	–	◀50▶
		3 1/2" Raumspar / Salvaspazio	✓	
		3 1/2" Tipo	–	
Daneo DAN 100-45 Ambio (mit Riffel / con scanalatura)	Edelstahl, matt Acciaio inox, opaco	3 1/2" TouchFlow	–	
		3 1/2" Raumspar / Salvaspazio	✓	
		3 1/2" Tipo	–	

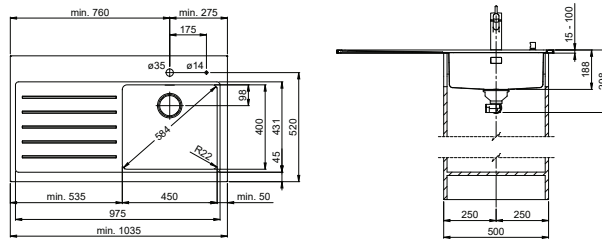



Masse für Variante ohne Riffel identisch.
Dimensioni identiche per variante senza scanalatura.

 Schwenkbare Überlaufkappe
Trotoppieno coperto con placchetta a ribalta

 Version Tropfteil links oder rechts erhältlich. Erhältlich für SmartSteel Collection in folgenden Oberflächen:
Scolatoio disponibile in versione per posizionamento a sinistra o a destra. Disponibile per SmartSteel Collection nelle seguenti finiture:

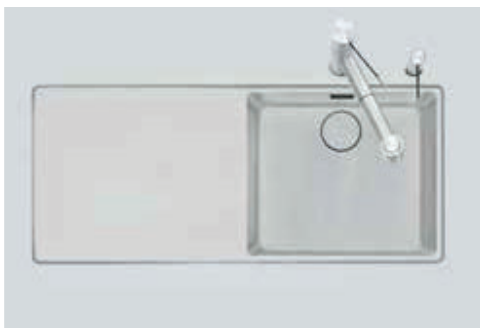
Standard SF BF WF



Modell Modello	Material Materiale	Ventil sFlow, Typ M Piletta sFlow, tipo M	 Advant	 in / in cm
Daneo DAN 100-45 EL Ambio	Edelstahl, matt Acciaio inox, opaco	3 1/2" eFlow Desino	–	◀50▶
		3 1/2" TouchFlow Desino	–	
		3 1/2" Raumspar Desino / Salvaspazio Desino	✓	
Daneo DAN 100-45 Ambio (mit Riffel / con scanalatura)	Edelstahl, matt Acciaio inox, opaco	3 1/2" eFlow Desino	–	
		3 1/2" TouchFlow Desino	–	
		3 1/2" Raumspar Desino / Salvaspazio Desino	✓	

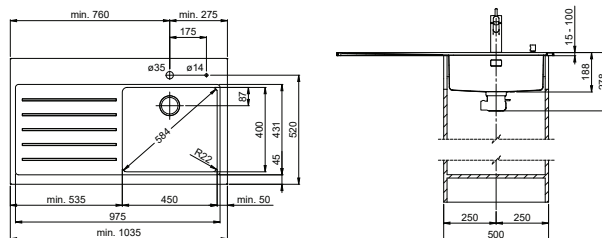

Masse für Variante ohne Riffel identisch.
Dimensioni identiche per variante senza scanalatura.

 Version Tropfteil links oder rechts erhältlich. Erhältlich für SmartSteel Collection in folgenden Oberflächen:
Scolatoio disponibile in versione per posizionamento a sinistra o a destra. Disponibile per SmartSteel Collection nelle seguenti finiture:

Standard SF BF WF

 eFlow mit eControl
eFlow con eControl

27

 Schwenkbare Überlaufkappe
Placchetta di trotoppieno a ribalta

27

 Desino: Verdeckter Ablauf mit untenliegendem Sieb
Desino: Scarico coperto con griglietta inferiore

26



Für eFlow Desino
Per eFlow Desino

Für TouchFlow Desino und Raumspar Desino
Per TouchFlow Desino e Salvaspazio Desino

Für eFlow Desino, TouchFlow Desino und Raumspar Desino
Per eFlow Desino, TouchFlow Desino e Salvaspazio Desino

Ambio

Küchenzubehör ab Seite / Accessori a partire dalla pagina 309



Modell Modello	Material Materiale	Ventil sFlow, Typ S Piletta sFlow, tipo S	Advant	in / in cm
Daneo DAN 100-50 EL Ambio	Edelstahl, matt Acciaio inox, opaco	3 1/2" TouchFlow	–	◀55▶
		3 1/2" Raumspar / Salvaspazio	✓	
		3 1/2" Tipo	–	
Daneo DAN 100-50 Ambio (mit Riffel / con scanalatura)	Edelstahl, matt Acciaio inox, opaco	3 1/2" TouchFlow	–	
		3 1/2" Raumspar / Salvaspazio	✓	
		3 1/2" Tipo	–	

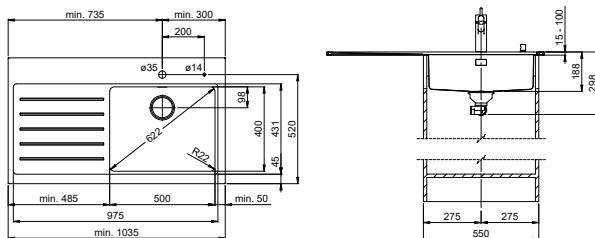

Masse für Variante ohne Riffel identisch.
Dimensioni identiche per variante senza scanalatura.

Schwenkbare Überlaufkappe
Trotoppieno coperto con placchetta a ribalta

Version Tropfteil links oder rechts erhältlich. Erhältlich für SmartSteel Collection in folgenden Oberflächen:
Scolatoio disponibile in versione per posizionamento a sinistra o a destra. Disponibile per SmartSteel Collection nelle seguenti finiture:

Standard SF BF WF

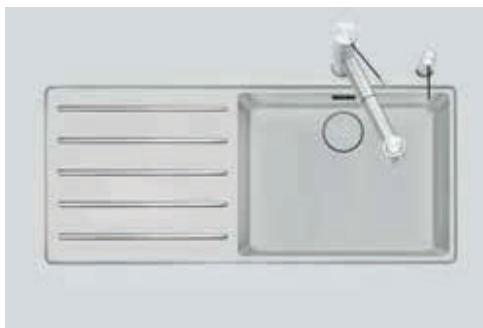
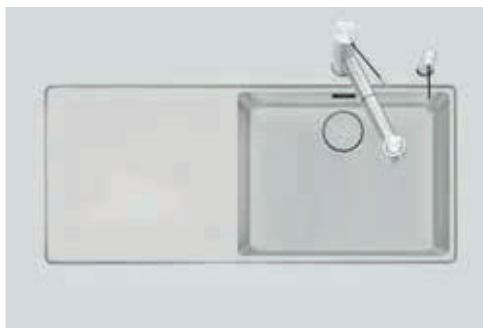

Modell Modello	Material Materiale	Ventil sFlow, Typ M Piletta sFlow, tipo M	Advant	in / in cm
Daneo DAN 100-50 EL Ambio	Edelstahl, matt Acciaio inox, opaco	3 1/2" eFlow Desino	–	◀55▶
		3 1/2" TouchFlow Desino	–	
		3 1/2" Raumspar Desino / Salvaspazio Desino	✓	
Daneo DAN 100-50 Ambio (mit Riffel / con scanalatura)	Edelstahl, matt Acciaio inox, opaco	3 1/2" eFlow Desino	–	
		3 1/2" TouchFlow Desino	–	
		3 1/2" Raumspar Desino / Salvaspazio Desino	✓	

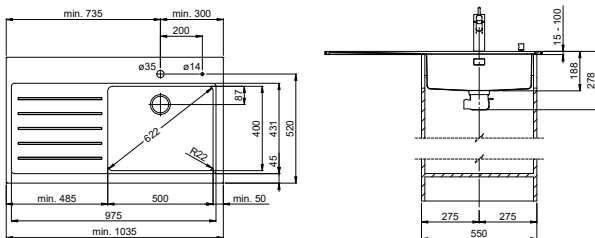

Masse für Variante ohne Riffel identisch.
Dimensioni identiche per variante senza scanalatura.

Version Tropfteil links oder rechts erhältlich. Erhältlich für SmartSteel Collection in folgenden Oberflächen:
Scolatoio disponibile in versione per posizionamento a sinistra o a destra. Disponibile per SmartSteel Collection nelle seguenti finiture:

Standard SF BF WF

eFlow mit eControl
eFlow con eControl

27

Schwenkbare Überlaufkappe
Placchetta di trotoppieno a ribalta

27

Desino: Verdeckter Ablauf mit untenliegendem Sieb
Desino: Scarico coperto con griglietta inferiore

26



Für eFlow Desino
Per eFlow Desino



Für TouchFlow Desino und Raumspar Desino
Per TouchFlow Desino e Salvaspazio Desino



Für eFlow Desino, TouchFlow Desino und Raumspar Desino
Per eFlow Desino, TouchFlow Desino e Salvaspazio Desino

Ambio

Küchenzubehör ab Seite / Accessori a partire dalla pagina 309

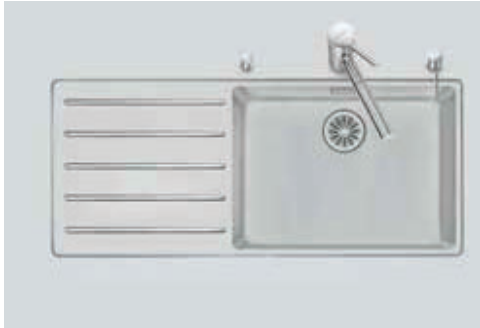
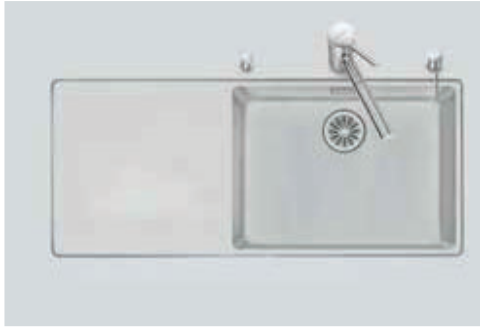

Modell Modello	Material Materiale	Ventil sFlow, Typ S Piletta sFlow, tipo S	Advant	in / in cm
Daneo DAN 100-55 EL Ambio	Edelstahl, matt Acciaio inox, opaco	3 1/2" TouchFlow	–	◀60▶
		3 1/2" Raumspar / Salvaspazio	✓	
		3 1/2" Tipo	–	
Daneo DAN 100-55 Ambio (mit Riffel / con scanalatura)	Edelstahl, matt Acciaio inox, opaco	3 1/2" TouchFlow	–	
		3 1/2" Raumspar / Salvaspazio	✓	
		3 1/2" Tipo	–	

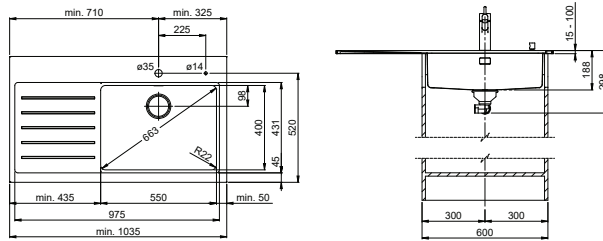

Masse für Variante ohne Riffel identisch.
Dimensioni identiche per variante senza scanalatura.

Schwenkbare Überlaufkappe
Troppopieno coperto con placchetta a ribalta

Version Tropfteil links oder rechts erhältlich. Erhältlich für SmartSteel Collection in folgenden Oberflächen:
Scolatoio disponibile in versione per posizionamento a sinistra o a destra. Disponibile per SmartSteel Collection nelle seguenti finiture:

Standard SF BF WF

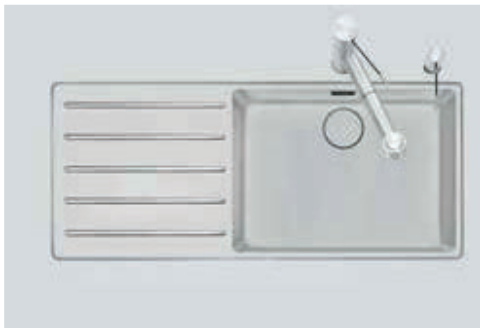
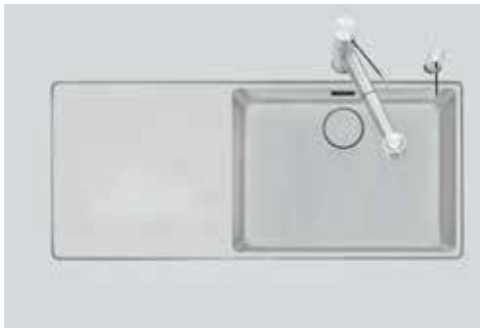

Modell Modello	Material Materiale	Ventil sFlow, Typ M Piletta sFlow, tipo M	Advant	in / in cm
Daneo DAN 100-55 EL Ambio	Edelstahl, matt Acciaio inox, opaco	3 1/2" eFlow Desino	–	◀60▶
		3 1/2" TouchFlow Desino	–	
		3 1/2" Raumspar Desino / Salvaspazio Desino	✓	
Daneo DAN 100-55 Ambio (mit Riffel / con scanalatura)	Edelstahl, matt Acciaio inox, opaco	3 1/2" eFlow Desino	–	
		3 1/2" TouchFlow Desino	–	
		3 1/2" Raumspar Desino / Salvaspazio Desino	✓	

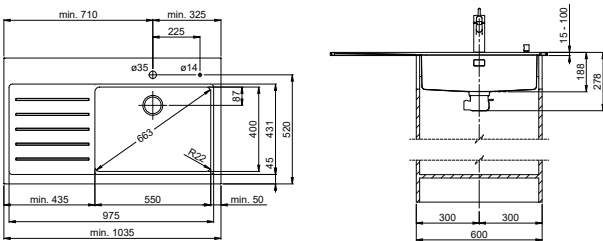

Masse für Variante ohne Riffel identisch.
Dimensioni identiche per variante senza scanalatura.

Version Tropfteil links oder rechts erhältlich. Erhältlich für SmartSteel Collection in folgenden Oberflächen:
Scolatoio disponibile in versione per posizionamento a sinistra o a destra. Disponibile per SmartSteel Collection nelle seguenti finiture:

Standard SF BF WF

eFlow mit eControl
eFlow con eControl

27

Schwenkbare Überlaufkappe
Placchetta di troppopieno a ribalta

27

Desino: Verdeckter Ablauf mit untenliegendem Sieb
Desino: Scarico coperto con griglietta inferiore

26



Für eFlow Desino
Per eFlow Desino



Für TouchFlow Desino und Raumspar Desino
Per TouchFlow Desino e Salvaspazio Desino



Für eFlow Desino, TouchFlow Desino und Raumspar Desino
Per eFlow Desino, TouchFlow Desino e Salvaspazio Desino

Classic

Küchenzubehör ab Seite / Accessori a partire dalla pagina 309



Modell Modello	Material Materiale	Ventil sFlow, Typ S Piletta sFlow, tipo S	Prime	in / in cm
Vantis V 90-45 EL Classic	Edelstahl, matt Acciaio inox, opaco	3 1/2" TouchFlow	—	450 ▶
		3 1/2" Raumspar / Salvaspazio	✓	
		3 1/2" Tipo	—	
Vantis V 90-45 Classic (mit Riffel / con scanalatura)	Edelstahl, matt Acciaio inox, opaco	3 1/2" TouchFlow	—	
		3 1/2" Raumspar / Salvaspazio	✓	
		3 1/2" Tipo	—	

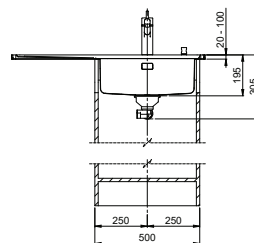
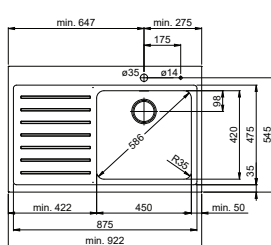

Masse für Variante ohne Riffel identisch.
Dimensioni identiche per variante senza scanalatura.

Schwenkbare Überlaufkappe
Troppopieno coperto con placchetta a ribalta

Version Tropfteil links oder rechts erhältlich. Erhältlich für SmartSteel Collection in folgenden Oberflächen:
Scolatoio disponibile in versione per posizionamento a sinistra o a destra. Disponibile per SmartSteel Collection nelle seguenti finiture:

Standard SF BF BX WF

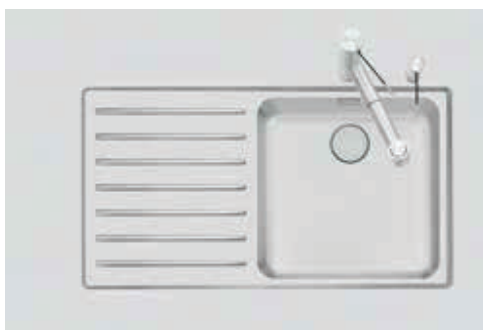
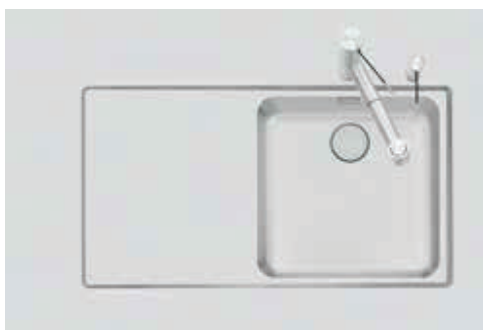

Modell Modello	Material Materiale	Ventil sFlow, Typ M Piletta sFlow, tipo M	Advant	in / in cm
Vantis V 90-45 EL Classic	Edelstahl, matt Acciaio inox, opaco	3 1/2" eFlow Desino	—	450 ▶
		3 1/2" TouchFlow Desino	—	
		3 1/2" Raumspar Desino / Salvaspazio Desino	✓	
Vantis V 90-45 Classic (mit Riffel / con scanalatura)	Edelstahl, matt Acciaio inox, opaco	3 1/2" eFlow Desino	—	
		3 1/2" TouchFlow Desino	—	
		3 1/2" Raumspar Desino / Salvaspazio Desino	✓	

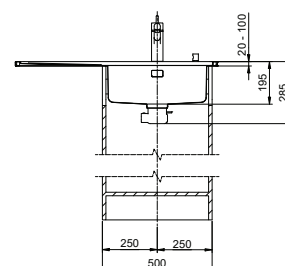
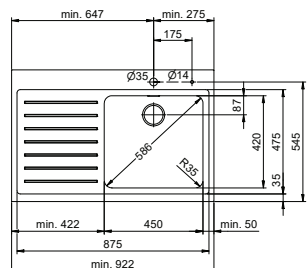

Masse für Variante ohne Riffel identisch.
Dimensioni identiche per variante senza scanalatura.

Version Tropfteil links oder rechts erhältlich. Erhältlich für SmartSteel Collection in folgenden Oberflächen:
Scolatoio disponibile in versione per posizionamento a sinistra o a destra. Disponibile per SmartSteel Collection nelle seguenti finiture:

Standard SF BF WF

eFlow mit eControl
eFlow con eControl

27

Schwenkbare Überlaufkappe
Placchetta di troppopieno a ribalta

27

Desino: Verdeckter Ablauf mit untenliegendem Sieb
Desino: Scarico coperto con griglietta inferiore

26



Für eFlow Desino
Per eFlow Desino

Für TouchFlow Desino und Raumspar Desino
Per TouchFlow Desino e Salvaspazio Desino

Für eFlow Desino, TouchFlow Desino und Raumspar Desino
Per eFlow Desino, TouchFlow Desino e Salvaspazio Desino

Classic

Küchenzubehör ab Seite / Accessori a partire dalla pagina 309



Schwenkbare Überlaufkappe
Troppopieno coperto con placchetta a ribalta

Version Tropfteil links oder rechts erhältlich. Erhältlich für SmartSteel Collection in folgenden Oberflächen:

Scolatoio disponibile in versione per posizionamento a sinistra o a destra. Disponibile per SmartSteel Collection nelle seguenti finiture:

Modell Modello	Material Materiale	Ventil sFlow, Typ S Piletta sFlow, tipo S	Prime	in / in cm
Vantis V 100-40 EL Classic	Edelstahl, matt Acciaio inox, opaco	3 1/2" TouchFlow	—	«45»
		3 1/2" Raumspar / Salvaspazio	✓	
		3 1/2" Tipo	—	
Vantis V 100-40 Classic (mit Riffel / con scanalatura)	Edelstahl, matt Acciaio inox, opaco	3 1/2" TouchFlow	—	
		3 1/2" Raumspar / Salvaspazio	✓	
		3 1/2" Tipo	—	

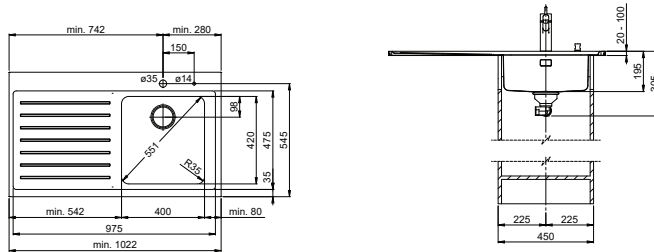

Masse für Variante ohne Riffel identisch.
Dimensioni identiche per variante senza scanalatura.

Standard **SF** **BF** **BX** **WF**



Modell Modello	Material Materiale	Ventil sFlow, Typ M Piletta sFlow, tipo M	Advant	in / in cm
Vantis V 100-40 EL Classic	Edelstahl, matt Acciaio inox, opaco	3 1/2" eFlow Desino	—	«45»
		3 1/2" TouchFlow Desino	—	
		3 1/2" Raumspar Desino / Salvaspazio Desino	✓	
Vantis V 100-40 Classic (mit Riffel / con scanalatura)	Edelstahl, matt Acciaio inox, opaco	3 1/2" eFlow Desino	—	
		3 1/2" TouchFlow Desino	—	
		3 1/2" Raumspar Desino / Salvaspazio Desino	✓	

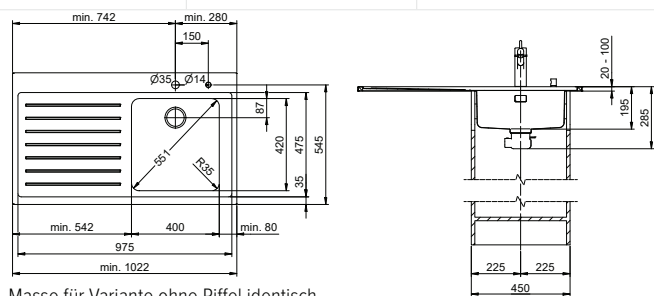

Masse für Variante ohne Riffel identisch.
Dimensioni identiche per variante senza scanalatura.

Version Tropfteil links oder rechts erhältlich. Erhältlich für SmartSteel Collection in folgenden Oberflächen:
Scolatoio disponibile in versione per posizionamento a sinistra o a destra. Disponibile per SmartSteel Collection nelle seguenti finiture:

Standard **SF** **BF** **WF**

eFlow mit eControl
eFlow con eControl

27

Schwenkbare Überlaufkappe
Placchetta di troppopieno a ribalta

27

Desino: Verdeckter Ablauf mit untenliegendem Sieb
Desino: Scarico coperto con griglietta inferiore

26



Für eFlow Desino
Per eFlow Desino

Für TouchFlow Desino und Raumspar Desino
Per TouchFlow Desino e Salvaspazio Desino

Für eFlow Desino, TouchFlow Desino und Raumspar Desino
Per eFlow Desino, TouchFlow Desino e Salvaspazio Desino

Classic

Küchenzubehör ab Seite / Accessori a partire dalla pagina 309



Modell Modello	Material Materiale	Ventil sFlow, Typ S Piletta sFlow, tipo S	Prime	in / in cm
Vantis V 100-45 EL Classic	Edelstahl, matt Acciaio inox, opaco	3 1/2" TouchFlow	-	450 ▶
		3 1/2" Raumspar / Salvaspazio	✓	
		3 1/2" Tipo	-	
Vantis V 100-45 Classic (mit Riffel / con scanalatura)	Edelstahl, matt Acciaio inox, opaco	3 1/2" TouchFlow	-	
		3 1/2" Raumspar / Salvaspazio	✓	
		3 1/2" Tipo	-	

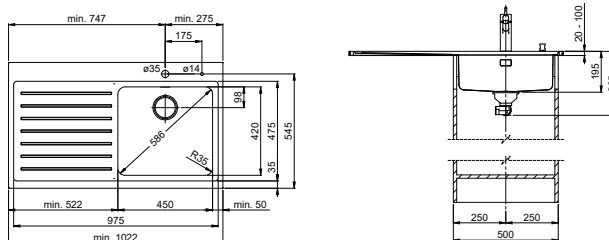

Masse für Variante ohne Riffel identisch.
Dimensioni identiche per variante senza scanalatura.

Schwenkbare Überlaufkappe
Troppopieno coperto con placchetta a ribalta

Version Tropfteil links oder rechts erhältlich. Erhältlich für SmartSteel Collection in folgenden Oberflächen:
Scolatoio disponibile in versione per posizionamento a sinistra o a destra. Disponibile per SmartSteel Collection nelle seguenti finiture:

Standard SF BF BX WF



Modell Modello	Material Materiale	Ventil sFlow, Typ M Piletta sFlow, tipo M	Advant	in / in cm
Vantis V 100-45 EL Classic	Edelstahl, matt Acciaio inox, opaco	3 1/2" eFlow Desino	-	450 ▶
		3 1/2" TouchFlow Desino	-	
		3 1/2" Raumspar Desino / Salvaspazio Desino	✓	
Vantis V 100-45 Classic (mit Riffel / con scanalatura)	Edelstahl, matt Acciaio inox, opaco	3 1/2" eFlow Desino	-	
		3 1/2" TouchFlow Desino	-	
		3 1/2" Raumspar Desino / Salvaspazio Desino	✓	

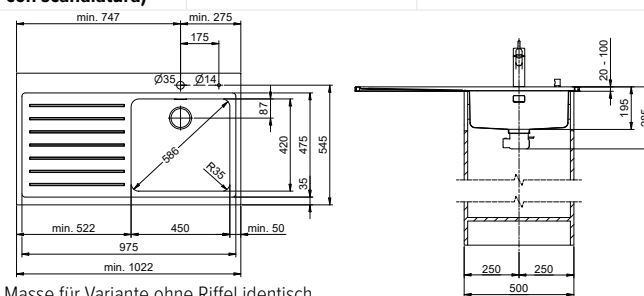

Masse für Variante ohne Riffel identisch.
Dimensioni identiche per variante senza scanalatura.

Version Tropfteil links oder rechts erhältlich. Erhältlich für SmartSteel Collection in folgenden Oberflächen:
Scolatoio disponibile in versione per posizionamento a sinistra o a destra. Disponibile per SmartSteel Collection nelle seguenti finiture:

Standard SF BF WF

eFlow mit eControl
eFlow con eControl

27

Schwenkbare Überlaufkappe
Placchetta di troppopieno a ribalta

27

Desino: Verdeckter Ablauf mit untenliegendem Sieb
Desino: Scarico coperto con griglietta inferiore

26



Für eFlow Desino
Per eFlow Desino



Für TouchFlow Desino und Raumspar Desino
Per TouchFlow Desino e Salvaspazio Desino



Für eFlow Desino, TouchFlow Desino und Raumspar Desino
Per eFlow Desino, TouchFlow Desino e Salvaspazio Desino

Classic

Küchenzubehör ab Seite / Accessori a partire dalla pagina 309



Schwenkbare Überlaufkappe
Troppieno coperto con placchetta a ribalta

Version Tropfteil links oder rechts erhältlich. Erhältlich für SmartSteel Collection in folgenden Oberflächen:
Scolatoio disponibile in versione per posizionamento a sinistra o a destra. Disponibile per SmartSteel Collection nelle seguenti finiture:



eFlow mit eControl
eFlow con eControl



Für eFlow Desino
Per eFlow Desino

Modell Modello	Material Materiale	Ventil sFlow, Typ S Piletta sFlow, tipo S	Prime	in / in cm
Vantis V 100-50 EL Classic	Edelstahl, matt Acciaio inox, opaco	3 1/2" TouchFlow	—	◀55▶
		3 1/2" Raumspar / Salvaspazio	✓	
		3 1/2" Tipo	—	
Vantis V 100-50 Classic (mit Riffel / con scanalatura)	Edelstahl, matt Acciaio inox, opaco	3 1/2" TouchFlow	—	
		3 1/2" Raumspar / Salvaspazio	✓	
		3 1/2" Tipo	—	

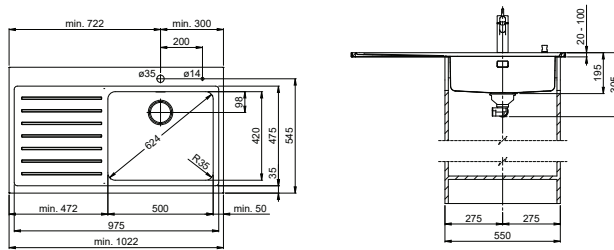

Masse für Variante ohne Riffel identisch.
Dimensioni identiche per variante senza scanalatura.

Standard SF BF BX WF

Modell Modello	Material Materiale	Ventil sFlow, Typ M Piletta sFlow, tipo M	Advant	in / in cm
Vantis V 100-50 EL Classic	Edelstahl, matt Acciaio inox, opaco	3 1/2" eFlow Desino	—	◀55▶
		3 1/2" TouchFlow Desino	—	
		3 1/2" Raumspar Desino / Salvaspazio Desino	✓	
Vantis V 100-50 Classic (mit Riffel / con scanalatura)	Edelstahl, matt Acciaio inox, opaco	3 1/2" eFlow Desino	—	
		3 1/2" TouchFlow Desino	—	
		3 1/2" Raumspar Desino / Salvaspazio Desino	✓	

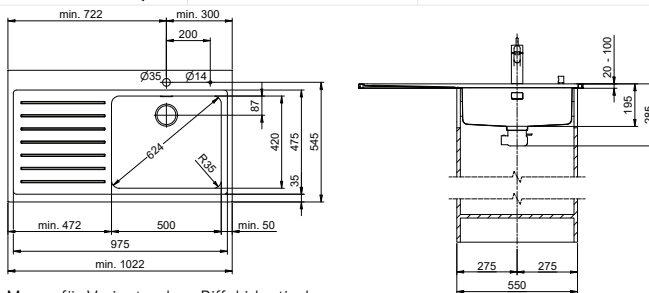

Masse für Variante ohne Riffel identisch.
Dimensioni identiche per variante senza scanalatura.

Version Tropfteil links oder rechts erhältlich. Erhältlich für SmartSteel Collection in folgenden Oberflächen:
Scolatoio disponibile in versione per posizionamento a sinistra o a destra. Disponibile per SmartSteel Collection nelle seguenti finiture:

Standard SF BF WF

Schwenkbare Überlaufkappe
Placchetta di troppieno a ribalta



Für TouchFlow Desino und Raumspar Desino
Per TouchFlow Desino e Salvaspazio Desino

Desino: Verdeckter Ablauf mit untenliegendem Sieb
Desino: Scarico coperto con griglietta inferiore



Für eFlow Desino, TouchFlow Desino und Raumspar Desino
Per eFlow Desino, TouchFlow Desino e Salvaspazio Desino

Classic

Küchenzubehör ab Seite / Accessori a partire dalla pagina 309



Modell Modello	Material Materiale	Ventil sFlow, Typ S Piletta sFlow, tipo S	Prime	in / in cm
Vantis V 100-55 EL Classic	Edelstahl, matt Acciaio inox, opaco	3 1/2" TouchFlow	–	◀60▶
		3 1/2" Raumspar / Salvaspazio	✓	
		3 1/2" Tipo	–	
Vantis V 100-55 Classic (mit Riffel/ con scanalatura)	Edelstahl, matt Acciaio inox, opaco	3 1/2" TouchFlow	–	
		3 1/2" Raumspar / Salvaspazio	✓	
		3 1/2" Tipo	–	

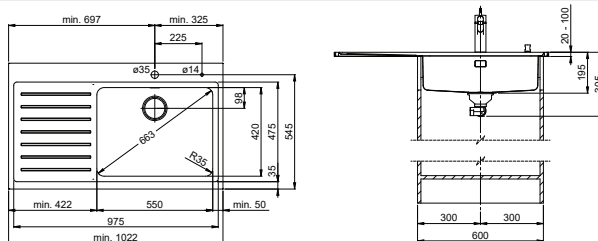

Masse für Variante ohne Riffel identisch.
Dimensioni identiche per variante senza scanalatura.

Schwenkbare Überlaufkappe
Troppopieno coperto con placchetta a ribalta

Version Tropfteil links oder rechts erhältlich. Erhältlich für SmartSteel Collection in folgenden Oberflächen:
Scolatoio disponibile in versione per posizionamento a sinistra o a destra. Disponibile per SmartSteel Collection nelle seguenti finiture:

Standard SF BF BX WF



Modell Modello	Material Materiale	Ventil sFlow, Typ M Piletta sFlow, tipo M	Advant	in / in cm
Vantis V 100-55 EL Classic	Edelstahl, matt Acciaio inox, opaco	3 1/2" eFlow Desino	–	◀60▶
		3 1/2" TouchFlow Desino	–	
		3 1/2" Raumspar Desino / Salvaspazio Desino	✓	
Vantis V 100-55 Classic (mit Riffel/ con scanalatura)	Edelstahl, matt Acciaio inox, opaco	3 1/2" eFlow Desino	–	
		3 1/2" TouchFlow Desino	–	
		3 1/2" Raumspar Desino / Salvaspazio Desino	✓	

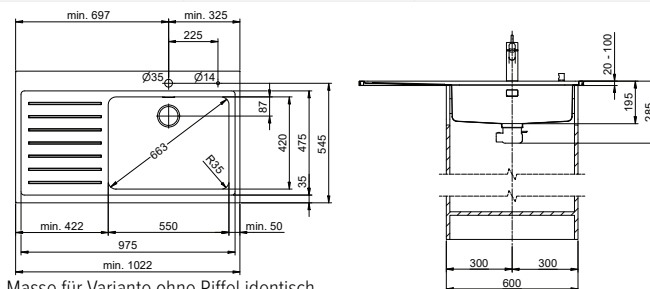

Masse für Variante ohne Riffel identisch.
Dimensioni identiche per variante senza scanalatura.

Version Tropfteil links oder rechts erhältlich. Erhältlich für SmartSteel Collection in folgenden Oberflächen:
Scolatoio disponibile in versione per posizionamento a sinistra o a destra. Disponibile per SmartSteel Collection nelle seguenti finiture:

Standard SF BF WF

eFlow mit eControl
eFlow con eControl

27

Schwenkbare Überlaufkappe
Placchetta di troppopieno a ribalta

27

Desino: Verdeckter Ablauf mit untenliegendem Sieb
Desino: Scarico coperto con griglietta inferiore

26



Für eFlow Desino
Per eFlow Desino

Für TouchFlow Desino und Raumspar Desino
Per TouchFlow Desino e Salvaspazio Desino

Für eFlow Desino, TouchFlow Desino und Raumspar Desino
Per eFlow Desino, TouchFlow Desino e Salvaspazio Desino

Classic

Küchenzubehör ab Seite / Accessori a partire dalla pagina 309



Modell Modello	Material Materiale	Ventil Piletta	Prime	in / in cm
Vantis VX 90-45 EL Varix Classic	Edelstahl, mid-matt Acciaio inox, mid-matt	3 1/2" Raumspar / Salvaspazio	✓	◀50▶
		3 1/2" Siebstopfen / A tappo c. griglietta	–	
Vantis VX 90-45 Varix Classic (mit Riffel / con scanalatura)	Edelstahl, mid-matt Acciaio inox, mid-matt	3 1/2" Raumspar / Salvaspazio	✓	
		3 1/2" Siebstopfen / A tappo c. griglietta	–	

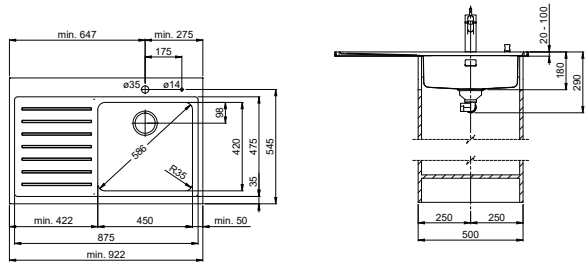

Masse für Variante ohne Riffel identisch.
Dimensioni identiche per variante senza scanalatura.

i Version Tropfteil links oder rechts erhältlich. Erhältlich für SmartSteel Collection in folgenden Oberflächen:

Scolatoio disponibile in versione per posizionamento a sinistra o a destra. Disponibile per SmartSteel Collection nelle seguenti finiture:

Standard SF BF BX WF

Standardoberflächen / Superfici standard

SF	Seidenmatt-Finish / Finitura satinata
BF	Breitband-Finish / Finitura a nastro largo
BX	Breitband Varix / Nastro largo Varix
WF	Wirbel-Finish / Finitura a turbino

Decor Oberflächen / Superfici Decor

PS	Polaris Silver
PB	Polaris Black
TR	Terra

Spezialoberflächen / Superfici speciali

ID	IceDesign™	PL	Polar Look	XB	Xrange Black
BI	BlackRange Industrial	XI	Xrange Ice	SL	Silk Look
BP	BlackRange Passion	XF	Xrange Fineline	WG	Warmgewalzt Laminazione a caldo

Alle Massangaben in mm
Unità di misura in mm

Classic

Küchenzubehör ab Seite / Accessori a partire dalla pagina 309



Modell Modello	Material Materiale	Ventil Piletta	Prime	in / in cm
Vantis VX 100-40 EL Varix Classic	Edelstahl, mid-matt	3 1/2" Raumspar / Salvaspazio	✓	◀45▶
	Acciaio inox, mid-matt	3 1/2" Siebstopfen / A tappo c. griglietta	–	
Vantis VX 100-40 Varix Classic (mit Riffel / con scanalatura)	Edelstahl, mid-matt	3 1/2" Raumspar / Salvaspazio	✓	
	Acciaio inox, mid-matt	3 1/2" Siebstopfen / A tappo c. griglietta	–	

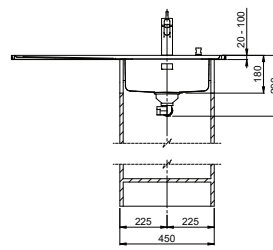
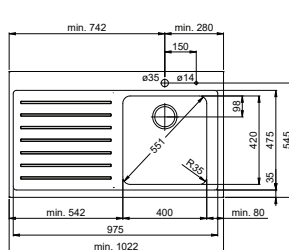

Masse für Variante ohne Riffel identisch.
Dimensioni identiche per variante senza scanalatura.

Standard SF BF BX WF

i Version Tropfteil links oder rechts erhältlich. Erhältlich für SmartSteel Collection in folgenden Oberflächen:
Scolatoio disponibile in versione per posizionamento a sinistra o a destra. Disponibile per SmartSteel Collection nelle seguenti finiture:



Modell Modello	Material Materiale	Ventil Piletta	Prime	in / in cm
Vantis VX 100-45 EL Varix Classic	Edelstahl, mid-matt	3 1/2" Raumspar / Salvaspazio	✓	◀50▶
	Acciaio inox, mid-matt	3 1/2" Siebstopfen / A tappo c. griglietta	–	
Vantis VX 100-45 Varix Classic (mit Riffel / con scanalatura)	Edelstahl, mid-matt	3 1/2" Raumspar / Salvaspazio	✓	
	Acciaio inox, mid-matt	3 1/2" Siebstopfen / A tappo c. griglietta	–	

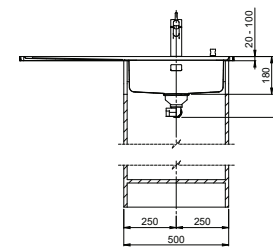
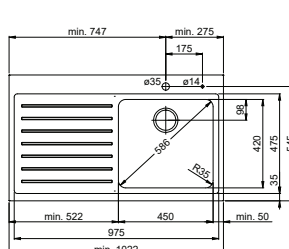

Masse für Variante ohne Riffel identisch.
Dimensioni identiche per variante senza scanalatura.

Standard SF BF BX WF

i Version Tropfteil links oder rechts erhältlich. Erhältlich für SmartSteel Collection in folgenden Oberflächen:
Scolatoio disponibile in versione per posizionamento a sinistra o a destra. Disponibile per SmartSteel Collection nelle seguenti finiture:

Standardoberflächen / Superfici standard

SF	Seidenmatt-Finish / Finitura satinata
BF	Breitband-Finish / Finitura a nastro largo
BX	Breitband Varix / Nastro largo Varix
WF	Wirbel-Finish / Finitura a turbino

Decor Oberflächen / Superfici Decor

PS	Polaris Silver
PB	Polaris Black
TR	Terra

Spezialoberflächen / Superfici speciali

ID	IceDesign™	PL	Polar Look	XB	Xrange Black
BI	BlackRange Industrial	XI	Xrange Ice	SL	Silk Look
BP	BlackRange Passion	XF	Xrange Fineline	WG	Warmgewalzt Laminazione a caldo

Alle Massangaben in mm
Unità di misura in mm

Classic

Küchenzubehör ab Seite / Accessori a partire dalla pagina 309

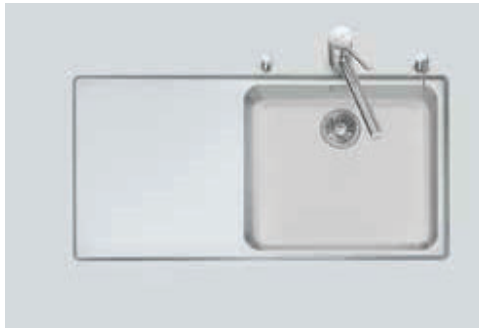

Modell Modello	Material Materiale	Ventil Piletta	Prime	in / in cm
Vantis VX 100-50 EL Varix Classic	Edelstahl, mid-matt	3 1/2" Raumspar / Salvaspazio	✓	◀55▶
	Acciaio inox, mid-matt	3 1/2" Siebstopfen / A tappo c. griglietta	–	
Vantis VX 100-50 Varix Classic (mit Riffel / con scanalatura)	Edelstahl, mid-matt	3 1/2" Raumspar / Salvaspazio	✓	
	Acciaio inox, mid-matt	3 1/2" Siebstopfen / A tappo c. griglietta	–	

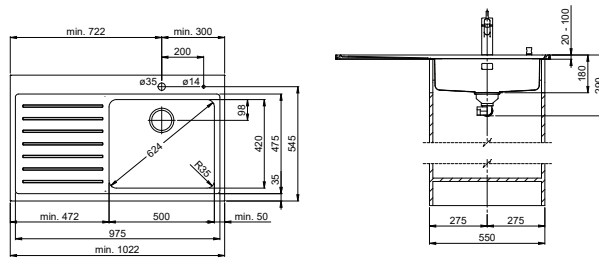

Masse für Variante ohne Riffel identisch.
Dimensioni identiche per variante senza scanalatura.

Standard SF BF BX WF

i Version Tropfteil links oder rechts erhältlich. Erhältlich für SmartSteel Collection in folgenden Oberflächen:
Scolatoio disponibile in versione per posizionamento a sinistra o a destra. Disponibile per SmartSteel Collection nelle seguenti finiture:

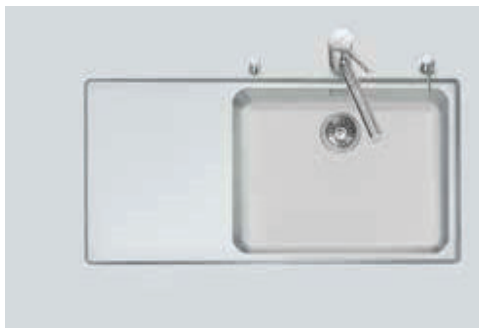

Modell Modello	Material Materiale	Ventil Piletta	Prime	in / in cm
Vantis VX 100-55 EL Varix Classic	Edelstahl, mid-matt	3 1/2" Raumspar / Salvaspazio	✓	◀60▶
	Acciaio inox, mid-matt	3 1/2" Siebstopfen / A tappo c. griglietta	–	
Vantis VX 100-55 Varix Classic (mit Riffel / con scanalatura)	Edelstahl, mid-matt	3 1/2" Raumspar / Salvaspazio	✓	
	Acciaio inox, mid-matt	3 1/2" Siebstopfen / A tappo c. griglietta	–	

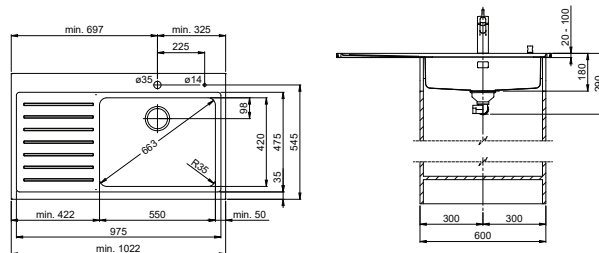

Masse für Variante ohne Riffel identisch.
Dimensioni identiche per variante senza scanalatura.

Standard SF BF BX WF

i Version Tropfteil links oder rechts erhältlich. Erhältlich für SmartSteel Collection in folgenden Oberflächen:
Scolatoio disponibile in versione per posizionamento a sinistra o a destra. Disponibile per SmartSteel Collection nelle seguenti finiture:

Standardoberflächen / Superfici standard

SF	Seidenmatt-Finish / Finitura satinata
BF	Breitband-Finish / Finitura a nastro largo
BX	Breitband Varix / Nastro largo Varix
WF	Wirbel-Finish / Finitura a turbino

Decor Oberflächen / Superfici Decor

PS	Polaris Silver
PB	Polaris Black
TR	Terra

Spezialoberflächen / Superfici speciali

ID	IceDesign™	PL	Polar Look	XB	Xrange Black
BI	BlackRange Industrial	XI	Xrange Ice	SL	Silk Look
BP	BlackRange Passion	XF	Xrange Finition	WG	Warmgewalzt Laminazione a caldo

Alle Massangaben in mm
Unità di misura in mm

Classic

Küchenzubehör ab Seite / Accessori a partire dalla pagina 309



Modell Modello	Material Materiale	Ventil Piletta	Prime	in / in cm
Silver Star SIL 90-45 EL Classic	Edelstahl, matt Acciaio inox, opaco	3 1/2" Raumspar / Salvaspazio	✓	◀50▶
		3 1/2" Tipo	–	
	Edelstahl, glanz Acciaio inox, lucido	3 1/2" Raumspar / Salvaspazio	✓	
		3 1/2" Tipo	–	
Silver Star SIL 90-45 Classic (mit Riffel / con scanalatura)	Edelstahl, matt Acciaio inox, opaco	3 1/2" Raumspar / Salvaspazio	✓	
		3 1/2" Tipo	–	
	Edelstahl, glanz Acciaio inox, lucido	3 1/2" Raumspar / Salvaspazio	✓	
		3 1/2" Tipo	–	

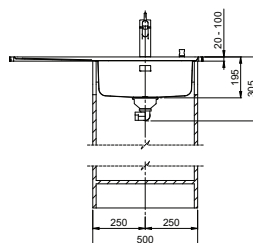
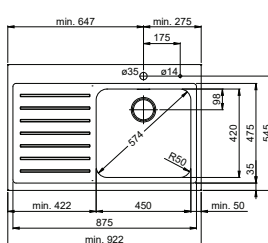

i Version Tropfteil links oder rechts erhältlich. Erhältlich für SmartSteel Collection in folgenden Oberflächen:

Scolatoio disponibile in versione per posizionamento a sinistra o a destra. Disponibile per SmartSteel Collection nelle seguenti finiture:

Standard SF BF BX WF

Masse für Variante ohne Riffel identisch.
Dimensioni identiche per variante senza scanalatura.



Modell Modello	Material Materiale	Ventil Piletta	Prime	in / in cm
Silver Star SIL 100-18/34 EL Classic	Edelstahl, matt Acciaio inox, opaco	3 1/2" Raumspar / Salvaspazio	✓	◀60▶
		3 1/2" Tipo	–	
	Edelstahl, glanz Acciaio inox, lucido	3 1/2" Raumspar / Salvaspazio	✓	
		3 1/2" Tipo	–	
Silver Star SIL 100-18/34 Classic (mit Riffel / con scanalatura)	Edelstahl, matt Acciaio inox, opaco	3 1/2" Raumspar / Salvaspazio	✓	
		3 1/2" Tipo	–	
	Edelstahl, glanz Acciaio inox, lucido	3 1/2" Raumspar / Salvaspazio	✓	
		3 1/2" Tipo	–	

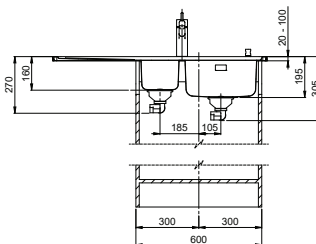
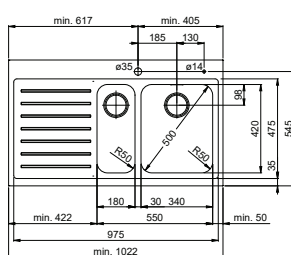

i Version Tropfteil links oder rechts erhältlich. Erhältlich für SmartSteel Collection in folgenden Oberflächen:

Scolatoio disponibile in versione per posizionamento a sinistra o a destra. Disponibile per SmartSteel Collection nelle seguenti finiture:

Standard SF BF BX WF

Masse für Variante ohne Riffel identisch.
Dimensioni identiche per variante senza scanalatura.

Classic

Küchenzubehör ab Seite / Accessori a partire dalla pagina 309



Modell Modello	Material Materiale	Ventil Piletta	Prime	in / in cm
Silver Star SIL 100-45 EL Classic	Edelstahl, matt Acciaio inox, opaco	3 1/2" Raumspar / Salvaspazio	✓	◀50▶
		3 1/2" Tipo	-	
	Edelstahl, glanz Acciaio inox, lucido	3 1/2" Raumspar / Salvaspazio	✓	
		3 1/2" Tipo	-	
Silver Star SIL 100-45 Classic (mit Riffel / con scanalatura)	Edelstahl, matt Acciaio inox, opaco	3 1/2" Raumspar / Salvaspazio	✓	
		3 1/2" Tipo	-	
	Edelstahl, glanz Acciaio inox, lucido	3 1/2" Raumspar / Salvaspazio	✓	
		3 1/2" Tipo	-	

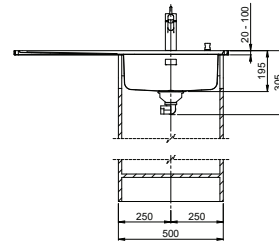
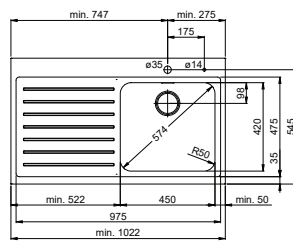

i Version Tropfteil links oder rechts erhältlich. Erhältlich für SmartSteel Collection in folgenden Oberflächen:

Scolatoio disponibile in versione per posizionamento a sinistra o a destra. Disponibile per SmartSteel Collection nelle seguenti finiture:

Standard SF BF BX WF

Masse für Variante ohne Riffel identisch.
Dimensioni identiche per variante senza scanalatura.



Modell Modello	Material Materiale	Ventil Piletta	Prime	in / in cm
Silver Star SIS 100-50 EL Classic	Edelstahl, matt Acciaio inox, opaco	3 1/2" Raumspar / Salvaspazio	✓	◀55▶
		3 1/2" Tipo	-	
	Edelstahl, glanz Acciaio inox, lucido	3 1/2" Raumspar / Salvaspazio	✓	
		3 1/2" Tipo	-	
Silver Star SIS 100-50 Classic (mit Riffel / con scanalatura)	Edelstahl, matt Acciaio inox, opaco	3 1/2" Raumspar / Salvaspazio	✓	
		3 1/2" Tipo	-	
	Edelstahl, glanz Acciaio inox, lucido	3 1/2" Raumspar / Salvaspazio	✓	
		3 1/2" Tipo	-	

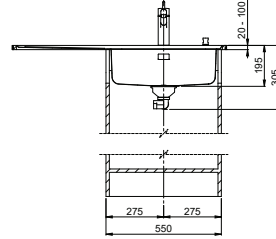
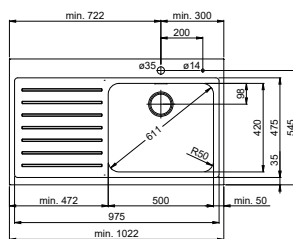

i Version Tropfteil links oder rechts erhältlich. Erhältlich für SmartSteel Collection in folgenden Oberflächen:

Scolatoio disponibile in versione per posizionamento a sinistra o a destra. Disponibile per SmartSteel Collection nelle seguenti finiture:

Standard SF BF BX WF

Masse für Variante ohne Riffel identisch.
Dimensioni identiche per variante senza scanalatura.

Silver Star

Küchenzubehör ab Seite / Accessori a partire dalla pagina 309



Modell Modello	Material Materiale	Ventil Piletta	Prime	in / in cm
Silver Star SIL 100-55 EL Classic	Edelstahl, matt Acciaio inox, opaco	3 1/2" Raumspar / Salvaspazio	✓	◀60▶
		3 1/2" Tipo	-	
	Edelstahl, glanz Acciaio inox, lucido	3 1/2" Raumspar / Salvaspazio	✓	
		3 1/2" Tipo	-	
Silver Star SIL 100-55 Classic (mit Riffel/ con scanalatura)	Edelstahl, matt Acciaio inox, opaco	3 1/2" Raumspar / Salvaspazio	✓	
		3 1/2" Tipo	-	
	Edelstahl, glanz Acciaio inox, lucido	3 1/2" Raumspar / Salvaspazio	✓	
		3 1/2" Tipo	-	

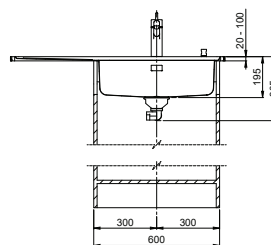
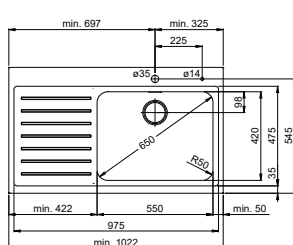

Masse für Variante ohne Riffel identisch.
Dimensioni identiche per variante senza scanalatura.

i Version Tropfteil links oder rechts erhältlich. Erhältlich für SmartSteel Collection in folgenden Oberflächen:
Scolatoio disponibile in versione per posizionamento a sinistra o a destra. Disponibile per SmartSteel Collection nelle seguenti finiture:

Standard SF BF BX WF



Modell Modello	Material Materiale	Ventil Piletta	Advant	in / in cm
SIL 100	Edelstahl, glanz Acciaio inox, lucido	3 1/2" Raumspar / Salvaspazio	✓	◀55▶
		3 1/2" Tipo	-	

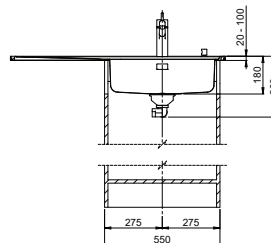
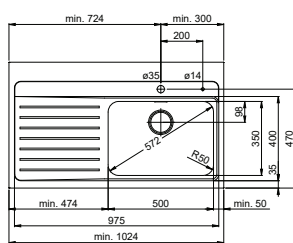

i Version Tropfteil links oder rechts erhältlich. Erhältlich für SmartSteel Collection in folgenden Oberflächen:
Scolatoio disponibile in versione per posizionamento a sinistra o a destra. Disponibile per SmartSteel Collection nelle seguenti finiture:

Standard SF BF BX WF

Standardoberflächen / Superfici standard

SF	Seidenmatt-Finish / Finitura satinata
BF	Breitband-Finish / Finitura a nastro largo
BX	Breitband Varix / Nastro largo Varix
WF	Wirbel-Finish / Finitura a turbino

Decor Oberflächen / Superfici Decor

PS	Polaris Silver
PB	Polaris Black
TR	Terra

Spezialoberflächen / Superfici speciali

ID	IceDesign™	PL	Polar Look	XB	Xrange Black
BI	BlackRange Industrial	XI	Xrange Ice	SL	Silk Look
BP	BlackRange Passion	XF	Xrange Fineline	WG	Warmgewalzt Laminazione a caldo

Alle Massangaben in mm
Unità di misura in mm

Comfort

Küchenzubehör ab Seite / Accessori a partire dalla pagina 309



i Version Tropfteil links oder rechts erhältlich. Erhältlich für SmartSteel Collection in folgenden Oberflächen:
Scolatoio disponibile in versione per posizionamento a sinistra o a destra. Disponibile per SmartSteel Collection nelle seguenti finiture:

Standard SF BF BX WF

Modell Modello	Material Materiale	Ventil Piletta	Prime	in / in cm
Comfort COM 75	Edelstahl, glanz Acciaio inox, lucido	3 1/2" Raumspar / Salvaspazio	✓	◀40▶
		3 1/2" Tipo	-	
		1 1/2" Standrohr / Con tubo	-	

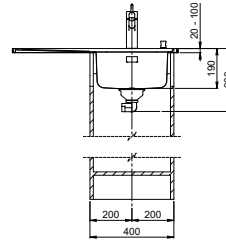
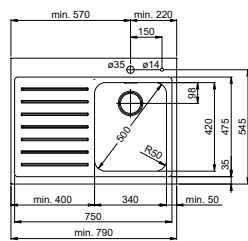

i Version Tropfteil links oder rechts erhältlich. Erhältlich für SmartSteel Collection in folgenden Oberflächen:
Scolatoio disponibile in versione per posizionamento a sinistra o a destra. Disponibile per SmartSteel Collection nelle seguenti finiture:

Standard SF BF BX WF

Modell Modello	Material Materiale	Ventil Piletta	Prime	in / in cm
Comfort COM 90	Edelstahl, glanz Acciaio inox, lucido	3 1/2" Raumspar / Salvaspazio	✓	◀40▶
		3 1/2" Tipo	-	
		1 1/2" Standrohr / Con tubo	-	

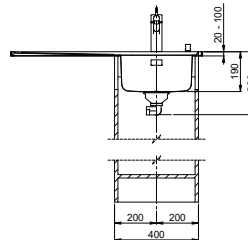
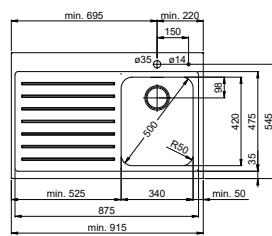

Modell Modello	Material Materiale	Ventil Piletta	Prime	in / in cm
Comfort COM 100-40 EL	Edelstahl, glanz Acciaio inox, lucido	3 1/2" Raumspar / Salvaspazio	✓	◀45▶
		3 1/2" Tipo	-	
Comfort COM 100-40 (mit Riffel / con scanalatura)	Edelstahl, glanz Acciaio inox, lucido	3 1/2" Raumspar / Salvaspazio	✓	
		3 1/2" Tipo	-	

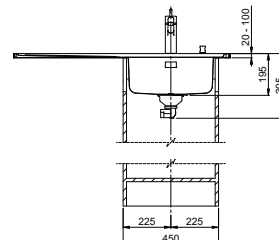
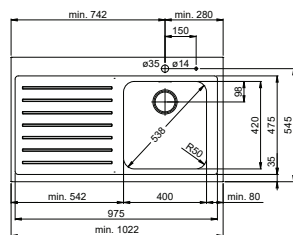

Masse für Variante ohne Riffel identisch.
Dimensioni identiche per variante senza scanalatura.

i Version Tropfteil links oder rechts erhältlich. Erhältlich für SmartSteel Collection in folgenden Oberflächen:
Scolatoio disponibile in versione per posizionamento a sinistra o a destra. Disponibile per SmartSteel Collection nelle seguenti finiture:

Standard SF BF BX WF

Comfort

Küchenzubehör ab Seite / Accessori a partire dalla pagina 309



i Version Tropfteil links oder rechts erhältlich. Erhältlich für SmartSteel Collection in folgenden Oberflächen:
Scolatoio disponibile in versione per posizionamento a sinistra o a destra. Disponibile per SmartSteel Collection nelle seguenti finiture:

Standard SF BF WF

Modell Modello	Material Materiale	Ventil Piletta	Prime	in / in cm
Comfort COM 135-34	Edelstahl, glanz Acciaio inox, lucido	3 1/2" Raumspar / Salvaspazio	✓	◀80▶
		3 1/2" Tipo	-	

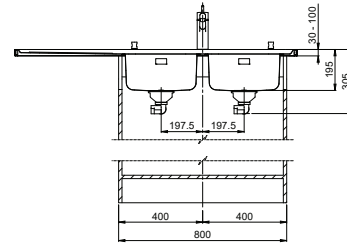
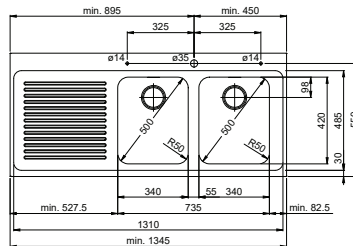

i Version Tropfteil links oder rechts erhältlich. Erhältlich für SmartSteel Collection in folgenden Oberflächen:
Scolatoio disponibile in versione per posizionamento a sinistra o a destra. Disponibile per SmartSteel Collection nelle seguenti finiture:

Standard SF BF WF

Modell Modello	Material Materiale	Ventil Piletta	Prime	in / in cm
Comfort COM 135-40	Edelstahl, glanz Acciaio inox, lucido	3 1/2" Raumspar / Salvaspazio	✓	◀90▶
		3 1/2" Tipo	-	

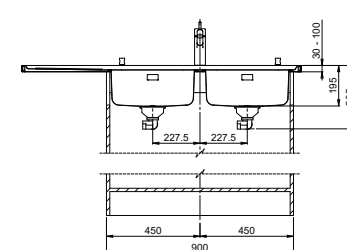
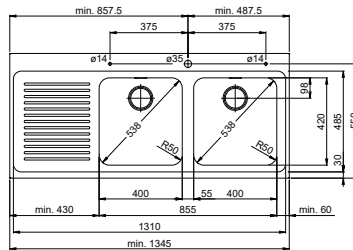

Standardoberflächen / Superfici standard

SF	Seidenmatt-Finish / Finitura satinata
BF	Breitband-Finish / Finitura a nastro largo
BX	Breitband Varix / Nastro largo Varix
WF	Wirbel-Finish / Finitura a turbino

Decor Oberflächen / Superfici Decor

PS	Polaris Silver
PB	Polaris Black
TR	Terra

Spezialoberflächen / Superfici speciali

ID	IceDesign™	PL	Polar Look	XB	Xrange Black
BI	BlackRange Industrial	XI	Xrange Ice	SL	Silk Look
BP	BlackRange Passion	XF	Xrange Finline	WG	Warmgewalzt Laminazione a caldo

Alle Massangaben in mm
Unità di misura in mm

Manufaktur Tropfteile / Scolatoi di manifattura

Evo Manufaktur Tropfteil / Scolatoi di manifattura Evo

Küchenzubehör ab Seite / Accessori a partire dalla pagina 309

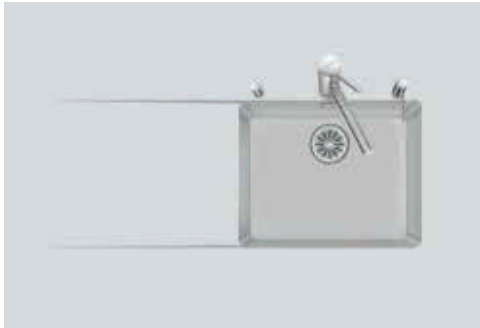

Schwenkbare Überlaufkappe
Troppieno coperto con placchetta a ribalta

Version Tropfteil links oder rechts erhältlich. Erhältlich für SmartSteel Collection in folgenden Oberflächen:
Scolatoio disponibile in versione per posizionamento a sinistra o a destra. Disponibile per SmartSteel Collection nelle seguenti finiture:

Standard SF BF WF

Modell Modello	Material Materiale	Ventil sFlow, Typ S Piletta sFlow, tipo S	Advant	in / in cm
Daneo DAN 50 Evo	Edelstahl, matt Acciaio inox, opaco	3 1/2" TouchFlow	—	◀55▶
		3 1/2" Raumspar / Salvaspazio	✓	
		3 1/2" Tipo	—	

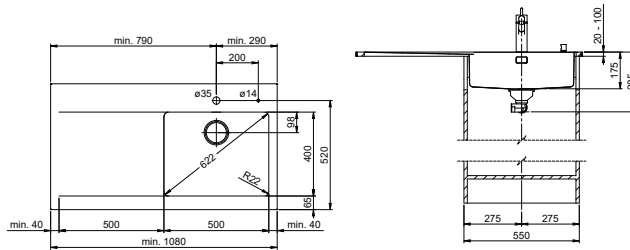

Version Tropfteil links oder rechts erhältlich. Erhältlich für SmartSteel Collection in folgenden Oberflächen:
Scolatoio disponibile in versione per posizionamento a sinistra o a destra. Disponibile per SmartSteel Collection nelle seguenti finiture:

Standard SF BF WF

Modell Modello	Material Materiale	Ventil sFlow, Typ M Piletta sFlow, tipo M	Advant	in / in cm
Daneo DAN 50 Evo	Edelstahl, matt Acciaio inox, opaco	3 1/2" eFlow Desino	—	◀55▶
		3 1/2" TouchFlow Desino	—	
		3 1/2" Raumspar Desino / Salvaspazio Desino	✓	

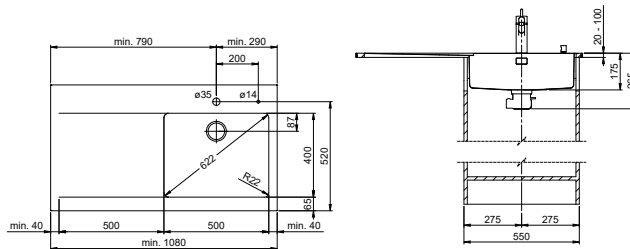

eFlow mit eControl
eFlow con eControl



Für eFlow Desino
Per eFlow Desino

Schwenkbare Überlaufkappe
Placchetta di troppieno a ribalta



Für TouchFlow Desino und Raumspar Desino
Per TouchFlow Desino e Salvaspazio Desino

Desino: Verdeckter Ablauf mit untenliegendem Sieb
Desino: Scarico coperto con griglietta inferiore



Für eFlow Desino, TouchFlow Desino und Raumspar Desino
Per eFlow Desino, TouchFlow Desino e Salvaspazio Desino

Standardoberflächen / Superfici standard

SF	Seidenmatt-Finish / Finitura satinata
BF	Breitband-Finish / Finitura a nastro largo
BX	Breitband Varix / Nastro largo Varix
WF	Wirbel-Finish / Finitura a turbino

Decor Oberflächen / Superfici Decor

PS	Polaris Silver
PB	Polaris Black
TR	Terra

Spezialoberflächen / Superfici speciali

ID	IceDesign™	PL	Polar Look	XB	Xrange Black
BI	BlackRange Industrial	XI	Xrange Ice	SL	Silk Look
BP	BlackRange Passion	XF	Xrange Finline	WG	Warmgewalzt Laminazione a caldo

Alle Massangaben in mm
Unità di misura in mm

Evo Manufaktur Tropfteil / Scolatoi di manifattura Evo

Küchenzubehör ab Seite / Accessori a partire dalla pagina 309

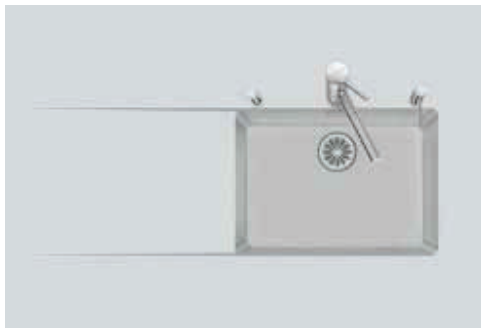

Schwenkbare Überlaufkappe
Trooppieno coperto con placchetta a ribalta

Version Tropfteil links oder rechts erhältlich. Erhältlich für SmartSteel Collection in folgenden Oberflächen:
Scolatoio disponibile in versione per posizionamento a sinistra o a destra. Disponibile per SmartSteel Collection nelle seguenti finiture:

Standard SF BF WF

Modell Modello	Material Materiale	Ventil sFlow, Typ S Piletta sFlow, tipo S	Advant	in / in cm
Daneo DAN 55 Evo	Edelstahl, matt Acciaio inox, opaco	3 1/2" TouchFlow	—	◀60▶
		3 1/2" Raumspar / Salvaspazio	✓	
		3 1/2" Tipo	—	

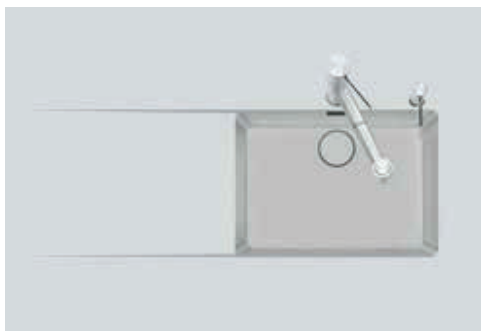
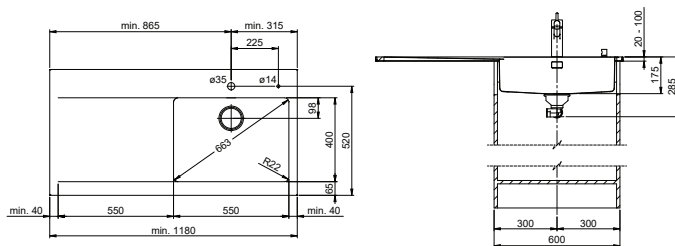

Version Tropfteil links oder rechts erhältlich. Erhältlich für SmartSteel Collection in folgenden Oberflächen:
Scolatoio disponibile in versione per posizionamento a sinistra o a destra. Disponibile per SmartSteel Collection nelle seguenti finiture:

Standard SF BF WF

Modell Modello	Material Materiale	Ventil sFlow, Typ M Piletta sFlow, tipo M	Advant	in / in cm
Daneo DAN 55 Evo	Edelstahl, matt Acciaio inox, opaco	3 1/2" eFlow Desino	—	◀60▶
		3 1/2" TouchFlow Desino	—	
		3 1/2" Raumspar Desino / Salvaspazio Desino	✓	

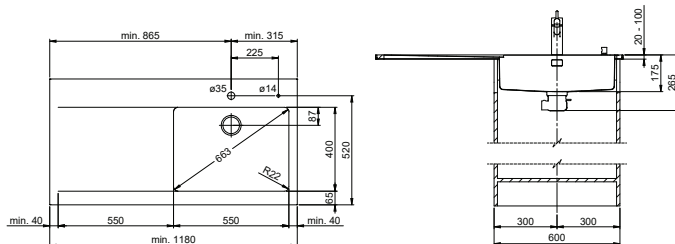

eFlow mit eControl
eFlow con eControl

Schwenkbare Überlaufkappe
Placchetta di trooppieno a ribalta

Desino: Verdeckter Ablauf mit untenliegendem Sieb
Desino: Scarico coperto con griglietta inferiore



Für eFlow Desino
Per eFlow Desino

Für TouchFlow Desino und Raumspar Desino
Per TouchFlow Desino e Salvaspazio Desino

Für eFlow Desino, TouchFlow Desino und Raumspar Desino
Per eFlow Desino, TouchFlow Desino e Salvaspazio Desino

Standardoberflächen / Superfici standard

SF	Seidenmatt-Finish / Finitura satinata
BF	Breitband-Finish / Finitura a nastro largo
BX	Breitband Varix / Nastro largo Varix
WF	Wirbel-Finish / Finitura a turbino

Decor Oberflächen / Superfici Decor

PS	Polaris Silver
PB	Polaris Black
TR	Terra

Spezialoberflächen / Superfici speciali

ID	IceDesign™	PL	Polar Look	XB	Xrange Black
BI	BlackRange Industrial	XI	Xrange Ice	SL	Silk Look
BP	BlackRange Passion	XF	Xrange Finline	WG	Warmgewalzt Laminazione a caldo

Alle Massangaben in mm
Unità di misura in mm

Kochfelder / Piani cottura

Ausschnitt für Kochfelder mit Auflagerahmen / Intaglio per piani di cottura con telaio di appoggio



Erhältliche Ausführung / Lavorazione disponibile

SmartSteel Collection



SolidSteel Collection



Weitere Produktinformationen / Altre informazioni prodotto

38

Erhältliche Oberflächen / Superfici disponibili

Standard

SF BF WF

Decor

PS PB TR

Spezial

ID BI BP PL XI XF XB SL WG

Weitere Produktinformationen / Altre informazioni prodotto

32-36

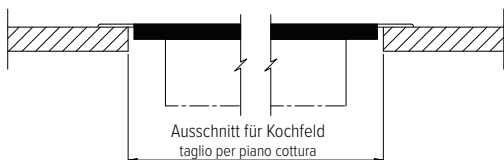
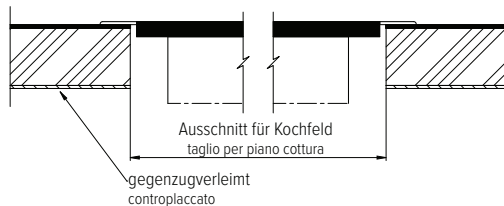

i Zur Vermeidung von Transportschäden bei der Ausführung SmartSteel Collection ist die durchgehende Spanplatte inkl. Gegenzugverleimung bauseits zu entfernen. Dies kann mit einem normalen Holzsaägeblatt bewerkstelligt werden.

Per evitare danni durante il trasporto, il pannello in truciolato comprensivo di controplaccatura dev'essere rimosso sul posto. Per farlo è possibile utilizzare una normale sega per legno.

Ausschnitt für Kochfelder mit Auflagerahmen Varix / Intaglio per piani di cottura con telaio di appoggio Varix



Erhältliche Ausführung / Lavorazione disponibile

SmartSteel Collection



SolidSteel Collection



Weitere Produktinformationen / Altre informazioni prodotto

38

Erhältliche Oberflächen / Superfici disponibili

Standard

SF BF BX WF

Weitere Produktinformationen / Altre informazioni prodotto

32-36

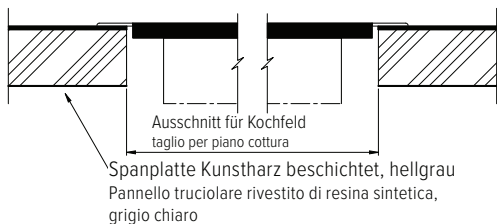

i Zur Vermeidung von Transportschäden bei der Ausführung SmartSteel Collection ist die durchgehende Spanplatte bauseits zu entfernen. Dies kann mit einem normalen Holzsaägeblatt bewerkstelligt werden.

Per evitare danni durante il trasporto, il pannello in truciolato dev'essere rimosso sul posto. Per farlo è possibile utilizzare una normale sega per legno.

Standardoberflächen / Superfici standard

SF	Seidenmatt-Finish / Finitura satinata
BF	Breitband-Finish / Finitura a nastro largo
BX	Breitband Varix / Nastro largo Varix
WF	Wirbel-Finish / Finitura a turbino

Decor Oberflächen / Superfici Decor

PS	Polaris Silver
PB	Polaris Black
TR	Terra

Spezialoberflächen / Superfici speciali

ID	IceDesign™	PL	Polar Look	XB	Xrange Black
BI	BlackRange Industrial	XI	Xrange Ice	SL	Silk Look
BP	BlackRange Passion	XF	Xrange Finline	WG	Warmgewalzt Laminazione a caldo

Alle Massangaben in mm
Unità di misura in mm

Ausschnitt für Kochfelder flächenbündig eingebaut / Intaglio per piani di cottura montati a filo top



Erhältliche Ausführung / Lavorazione disponibile

SmartSteel Collection

SolidSteel Collection

Weitere Produktinformationen / Altre informazioni prodotto 38

Erhältliche Oberflächen / Superfici disponibili

Standard	SF	BF	WF						
Decor	PS	PB	TR						
Spezial	ID	BI	BP	PL	XI	XF	XB	SL	WG

Weitere Produktinformationen / Altre informazioni prodotto 32-36

SmartSteel Collection

Mass variabel nach Kochfeld-Hersteller
dimensioni variabili in base al produttore del piano cottura

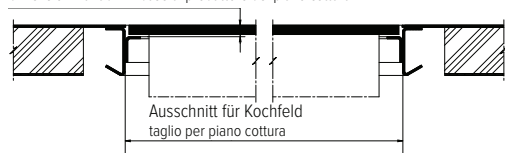

SolidSteel Collection

Mass variabel nach Kochfeld-Hersteller
dimensioni variabili in base al produttore del piano cottura

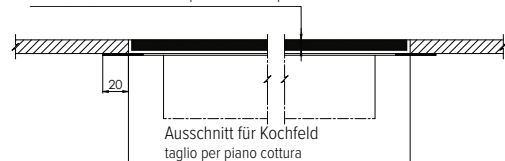

i Kochfeldrahmenaufbau bei Trägerplatte und Küchenmöbel beachten.
Nel montaggio del telaio per piano di cottura, prestare attenzione alla piastra di supporto e al mobilio della cucina.

Ausschnitt für Kochfelder flächenbündig eingebaut Varix / Intaglio per piani di cottura montati a filo top Varix



Erhältliche Ausführung / Lavorazione disponibile

SmartSteel Collection

SolidSteel Collection

Weitere Produktinformationen / Altre informazioni prodotto 38

Erhältliche Oberflächen / Superfici disponibili

Standard	SF	BF	BX	WF
----------	----	----	----	----

Weitere Produktinformationen / Altre informazioni prodotto 32

Mass variabel nach Kochfeld-Hersteller
dimensioni variabili in base al produttore del piano cottura

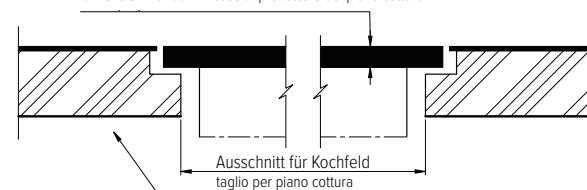

Spanplatte Kunstharz beschichtet, hellgrau
Pannello truciolare rivestito di resina sintetica,
grigio chiaro

Standardoberflächen / Superfici standard

SF	Seidenmatt-Finish / Finitura satinata
BF	Breitband-Finish / Finitura a nastro largo
BX	Breitband Varix / Nastro largo Varix
WF	Wirbel-Finish / Finitura a turbino

Decor Oberflächen / Superfici Decor

PS	Polaris Silver
PB	Polaris Black
TR	Terra

Spezialoberflächen / Superfici speciali

ID	IceDesign™	PL	Polar Look	XB	Xrange Black
BI	BlackRange Industrial	XI	Xrange Ice	SL	Silk Look
BP	BlackRange Passion	XF	Xrange Finline	WG	Warmgewalzt Laminazione a caldo

Alle Massangaben in mm
Unità di misura in mm

Ausschnitt mit Auflagerahmen / Intaglio per telaio di appoggio

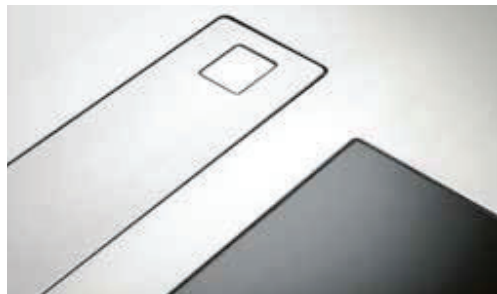

Erhältliche Ausführung / Lavorazione disponibile

SmartSteel Collection



SolidSteel Collection



Weitere Produktinformationen / Altre informazioni prodotto



Erhältliche Oberflächen / Superfici disponibili

Standard

SF BF WF

Decor

PS PB TR

Spezial

ID BI BP PL XI XF XB SL WG

Weitere Produktinformationen / Altre informazioni prodotto



Ausschnitt für SmartSteel Collection mit oder ohne Verkleidung möglich.
Possibile intaglio per SmartSteel Collection con o senza rivestimento.

Standardoberflächen / Superfici standard

SF	Seidenmatt-Finish / Finitura satinata
BF	Breitband-Finish / Finitura a nastro largo
BX	Breitband Varix / Nastro largo Varix
WF	Wirbel-Finish / Finitura a turbino

Decor Oberflächen / Superfici Decor

PS	Polaris Silver
PB	Polaris Black
TR	Terra

Spezialoberflächen / Superfici speciali

ID	IceDesign™	PL	Polar Look	XB	Xrange Black
BI	BlackRange Industrial	XI	Xrange Ice	SL	Silk Look
BP	BlackRange Passion	XF	Xrange Fineline	WG	Warmgewalzt Laminazione a caldo

Alle Massangaben in mm
Unità di misura in mm

Rückwände, Seitenwände / Pannelli posteriori, pannelli laterali

Rück- und Seitenwände mehrteilig / Pannelli posteriori e fianchi in più parti

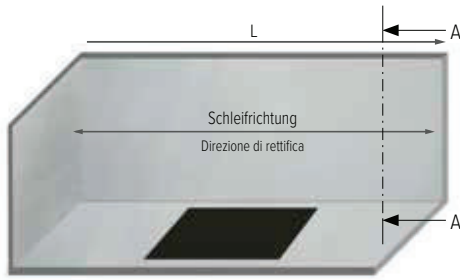

Schnitt A-A / Intaglio A-A

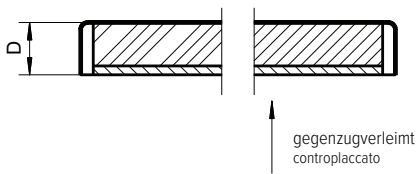

SolidSteel Collection

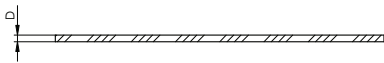

Erhältliche Ausführung / Lavorazione disponibile

SmartSteel Collection

SolidSteel Collection

Weitere Produktinformationen / Altre informazioni prodotto 38

Erhältliche Oberflächen / Superfici disponibili

Standard	SF	BF	WF							
Decor	PS	PB	TR							
Spezial	ID	BI	BP	PL	XI	XF	XB	SL	WG	

Weitere Produktinformationen / Altre informazioni prodotto 32-36

SmartSteel Collection

Kantenhöhe (D) Altezze di bordo (D)	max. Länge (L) / Lunghezza max (L)		max. Höhe (H) / Altezza max (H)	
	Standardoberflächen Superfici standard	Decor Oberflächen Superfici Decor	Standardoberflächen Superfici standard	Decor Oberflächen Superfici Decor
10	2500	2500	1750	1400
12/15/18/21	6000	3900	1750	1400

SolidSteel Collection

Kantenhöhe (D) Altezze di bordo (D)	max. Länge (L) / Lunghezza max (L)		max. Höhe (H) / Altezza max (H)	
	Standardoberflächen ¹ Superfici standard ¹	Spezialoberflächen ¹ Superfici speciali ¹	Standardoberflächen ¹ Superfici standard ¹	Spezialoberflächen ¹ Superfici speciali ¹
4/5/8	3980-4980 ¹	3900-4950 ¹	1980 ¹	1400-1480 ¹

¹Verfügbare Oberflächen und Abmessungen siehe Seite 38
¹Per la disponibilità di superfici e misure, vedi alla pagina

Rück- und Seitenwände mehrteilig Varix / Pannelli posteriori e fianchi in più parti Varix



Schnitt A-A / Intaglio A-A

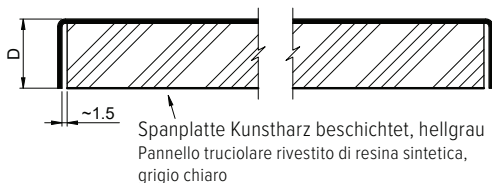

Erhältliche Ausführung / Lavorazione disponibile

SmartSteel Collection

SolidSteel Collection

Weitere Produktinformationen / Altre informazioni prodotto 38

Erhältliche Oberflächen / Superfici disponibili

Standard	SF	BF	BX	WF						
----------	----	----	----	----	--	--	--	--	--	--

Weitere Produktinformationen / Altre informazioni prodotto 32

SmartSteel Collection

Kantenhöhe (D) Hauteur de chant (D)	max. Länge (L) / Longueur maximale (L)		max. Höhe (H) / Hauteur maximale (H)	
	Varix		Varix	
11	2500		1400	
20	3900		1400	

Standardoberflächen / Superfici standard

SF	Seidenmatt-Finish / Finitura satinata
BF	Breitband-Finish / Finitura a nastro largo
BX	Breitband Varix / Nastro largo Varix
WF	Wirbel-Finish / Finitura a turbino

Decor Oberflächen / Superfici Decor

PS	Polaris Silver
PB	Polaris Black
TR	Terra

Spezialoberflächen / Superfici speciali

ID	IceDesign™	PL	Polar Look	XB	Xrange Black
BI	BlackRange Industrial	XI	Xrange Ice	SL	Silk Look
BP	BlackRange Passion	XF	Xrange Finline	WG	Warmgewalzt Laminazione a caldo

Alle Massangaben in mm
Unità di misura in mm

Rück- und Seitenwände mit Holz lose mitgeliefert / Pannelli posteriori e laterali con legno fornito separatamente



Schnitt A-A / Intaglio A-A

SmartSteel Collection

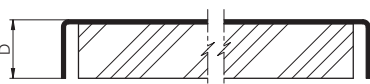

Erhältliche Ausführung / Lavorazione disponibile

SmartSteel Collection SolidSteel Collection

Weitere Produktinformationen / Altre informazioni prodotto 38

Erhältliche Oberflächen / Superfici disponibili

Standard	SF	BF	WF
Decor	PS	PB	TR

Weitere Produktinformationen / Altre informazioni prodotto 32+33

i Alle Ausschnitte, Schrägen (ausgenommen Schrägen ① und ② Seite 131) und Rundungen nur geschnitten möglich. Holz im Lieferumfang enthalten. Holzmontage auf Rückwand mit bauseitigem Montagekleber. Tutti gli intagli, smussi (eccetto smussi ① e ② a pagina 131) e stondature di bordi sono possibili solo pretagliati. Legno compreso nella fornitura. Montaggio del legno su pannello posteriore con collante fornito in loco.

Kantenhöhe (D) Altezze di bordo (D)	Holzstärke Spessore del legno	max. Länge (L) / Lunghezza max (L)		max. Höhe (H) / Altezza max (H)	
		Standardoberflächen Superfici standard	Decor Oberflächen Superfici Decor	Standardoberflächen Superfici standard	Decor Oberflächen Superfici Decor
9	8	2500	2500	600	600
11/14/17/20	10/13/16/19	3900	3900	900	900

Rück- und Seitenwände mehrteilig 1.5 mm / Pannelli posteriori e fianchi in più parti 1.5 mm

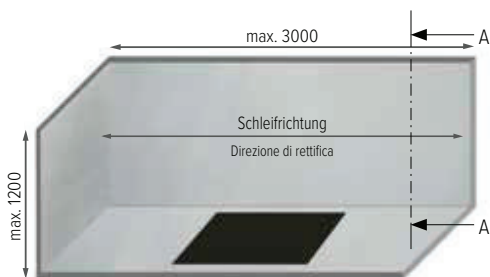

Schnitt A-A / Intaglio A-A

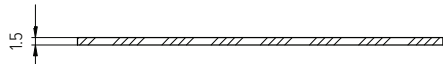

Erhältliche Ausführung / Lavorazione disponibile

SmartSteel Collection SolidSteel Collection

Weitere Produktinformationen / Altre informazioni prodotto 38

Erhältliche Oberflächen / Superfici disponibili

Standard	SF	BF	WF
----------	----	----	----

Weitere Produktinformationen / Altre informazioni prodotto 32

i Ferritischer Chrom Edelstahl, magnetisierbar. Im Preis inklusiv: Erster Steckdosenausschnitt, schräge Kanten, mittlerer Ausschnitt und Eckausschnitt.

Acciaio ferritico (al cromo), magnetizzabile. Inclusi nel prezzo: primo intaglio per presa elettrica, taglio inclinato bordi, intaglio intermedio e intaglio angolare.

Standardoberflächen / Superfici standard

SF	Seidenmatt-Finish / Finitura satinata
BF	Breitband-Finish / Finitura a nastro largo
BX	Breitband Varix / Nastro largo Varix
WF	Wirbel-Finish / Finitura a turbino

Decor Oberflächen / Superfici Decor

PS	Polaris Silver
PB	Polaris Black
TR	Terra

Spezialoberflächen / Superfici speciali

ID	IceDesign™	PL	Polar Look	XB	Xrange Black
BI	BlackRange Industrial	XI	Xrange Ice	SL	Silk Look
BP	BlackRange Passion	XF	Xrange Finline	WG	Warmgewalzt Laminazione a caldo

Alle Massangaben in mm
Unità di misura in mm

Tablare, Fronten und Sockelbleche / Ripiani, frontali e zoccolature

Tablare / Ripiani

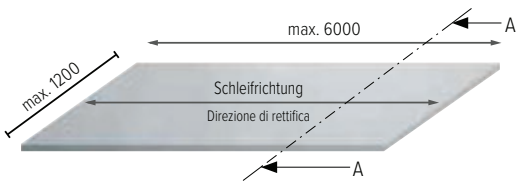

Schnitt A-A / Intaglio A-A

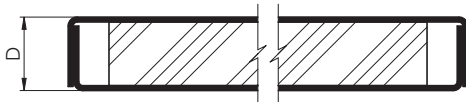

Kantenhöhe (D) Altezza di bordo (D)	max. Länge Lunghezza max.	max. Tiefe Profondità max.
15	2500	600
18 / 24 / 27	6000	1200

Erhältliche Ausführung / Lavorazione disponibile

SmartSteel Collection



SolidSteel Collection



Weitere Produktinformationen / Altre informazioni prodotto



Erhältliche Oberflächen / Superfici disponibili

Standard



Weitere Produktinformationen / Altre informazioni prodotto



i Unabhängig von der Ausführung und der Oberfläche wird die sichtbare Unterseite in der Oberfläche Breitband-Finish ausgeführt. Situativ wird in Abhängigkeit von der Länge eine zusätzliche Abstützung empfohlen.

Indipendentemente dal tipo di esecuzione e dalla superficie, il lato inferiore a vista viene eseguito con finitura superficiale a nastro largo. A seconda della lunghezza, si raccomanda l'uso di un supporto supplementare.

Fronten einbaufertig / Frontali pronti per il montaggio

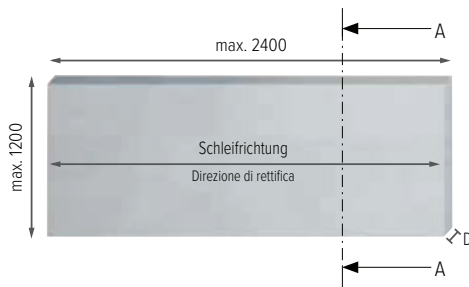

Schnitt A-A / Intaglio A-A



D	15.5	18.5
---	------	------

Erhältliche Ausführung / Lavorazione disponibile

SmartSteel Collection



SolidSteel Collection



Weitere Produktinformationen / Altre informazioni prodotto



Erhältliche Oberflächen / Superfici disponibili

Standard



Weitere Produktinformationen / Altre informazioni prodotto



Erhältliche Bohrungen Forature disponibili



Lochbohrung für Fronten \varnothing 3–65 mm
Foratura sul frontale \varnothing 3–65 mm

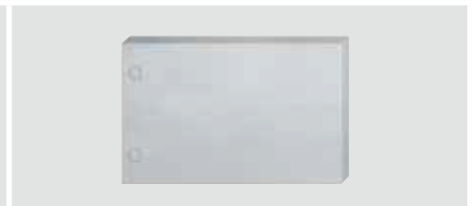

Bandbohrung in Fronten
Foratura per cerniere sul frontale

Standardoberflächen / Superfici standard

SF	Seidenmatt-Finish / Finitura satinata
BF	Breitband-Finish / Finitura a nastro largo
BX	Breitband Varix / Nastro largo Varix
WF	Wirbel-Finish / Finitura a turbino

Decor Oberflächen / Superfici Decor

PS	Polaris Silver
PB	Polaris Black
TR	Terra

Spezialoberflächen / Superfici speciali

ID	IceDesign™	PL	Polar Look	XB	Xrange Black
BI	BlackRange Industrial	XI	Xrange Ice	SL	Silk Look
BP	BlackRange Passion	XF	Xrange Finline	WG	Warmgewalzt Laminazione a caldo

Alle Massangaben in mm
Unità di misura in mm

Fronten zum bauseitig anpassen / Adattare i frontali



D	15.5	18.5
---	------	------

Erhältliche Ausführung / Lavorazione disponibile

SmartSteel Collection SolidSteel Collection

Weitere Produktinformationen / Altre informazioni prodotto 38

Erhältliche Oberflächen / Superfici disponibili

Standard SF BF WF

Weitere Produktinformationen / Altre informazioni prodotto 32

Empfohlener bauseitiger Arbeitsvorgang
Procedura raccomandata da eseguire

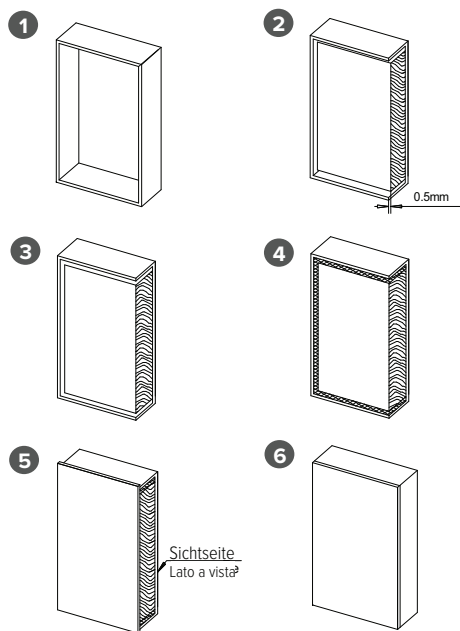

- 1 Schale ohne Holz / Struttura senza legno
- 2 Holz zurückstehend einleimen / Sincollare il legno con un margine rientrante
- 3 Blechplan schleifen / Rettificare in piano la lamiera
- 4 Spalt mit Silikon auffüllen / Riempire il margine con silicone
- 5 Rückseite beschichten / Ricoprire il lato posteriore
- 6 Vorstehende Kante abschleifen / Rimuovere il bordo sporgente anteriore

Erhältliche Bohrungen
Forature disponibili

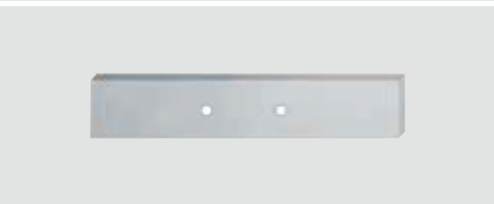

Lochbohrung für Fronten \varnothing 3–65 mm
Foratura sul frontale \varnothing 3–65 mm

i Fronten sind auch ohne eingeklebte Holzplatte erhältlich. Bitte bei Bestellung angeben.
Empfohlener bauseitiger Arbeitsvorgang für Weiterverarbeitung von Fronten ohne eingeklebte Holzplatte.
I frontali sono disponibili anche senza pannello in legno incollato. Si prega di precisare in sede di ordine.
Procedura raccomandata da eseguire sul posto per la rifinitura di frontali senza pannello in legno incollato.

Standardoberflächen / Superfici standard

SF	Seidenmatt-Finish / Finitura satinata
BF	Breitband-Finish / Finitura a nastro largo
BX	Breitband Varix / Nastro largo Varix
WF	Wirbel-Finish / Finitura a turbino

Decor Oberflächen / Superfici Decor

PS	Polaris Silver
PB	Polaris Black
TR	Terra

Spezialoberflächen / Superfici speciali

ID	IceDesign™	PL	Polar Look	XB	Xrange Black
BI	BlackRange Industrial	XI	Xrange Ice	SL	Silk Look
BP	BlackRange Passion	XF	Xrange Finline	WG	Warmgewalzt Laminazione a caldo

Alle Massangaben in mm
Unità di misura in mm

Sockelbleche / Lamiere per zoccoli

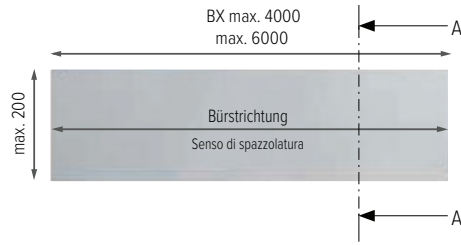

Schnitt A-A / Intaglio A-A

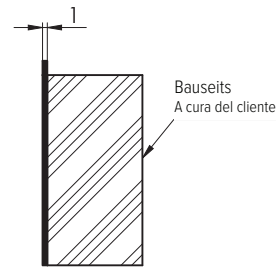

Erhältliche Ausführung / Lavorazione disponibile

SmartSteel Collection SolidSteel Collection

Weitere Produktinformationen / Altre informazioni prodotto 38

Erhältliche Oberflächen / Superfici disponibili

Standard SF BF BX WF
Decor PS PB TR

Weitere Produktinformationen / Altre informazioni prodotto 32+33

Erhältliche Ausführungen

Versioni disponibili

Abkantung / Piegature	Lüftungsöffnung nach Vorgabe. Apertura per ventilazione secondo specifica.	Ausschnitt / Taglio

i Massgenau zugeschnittene Edelstahlblechen, zwecks bauseitiger Aufleimung auf Küchensockel.
Abkantungen nur für Standardoberflächen erhältlich.

Lamiere in acciaio tagliate su misura da incollare in loco sullo zoccolo della cucina.
Piegature disponibili solo per superfici standard.

Standardoberflächen / Superfici standard

SF	Seidenmatt-Finish / Finitura satinata
BF	Breitband-Finish / Finitura a nastro largo
BX	Breitband Varix / Nastro largo Varix
WF	Wirbel-Finish / Finitura a turbino

Decor Oberflächen / Superfici Decor

PS	Polaris Silver
PB	Polaris Black
TR	Terra

Spezialoberflächen / Superfici speciali

ID	IceDesign™	PL	Polar Look	XB	Xrange Black
BI	BlackRange Industrial	XI	Xrange Ice	SL	Silk Look
BP	BlackRange Passion	XF	Xrange Finline	WG	Warmgewalzt Laminazione a caldo

Alle Massangaben in mm
Unità di misura in mm

Ausschnitte / Intagli

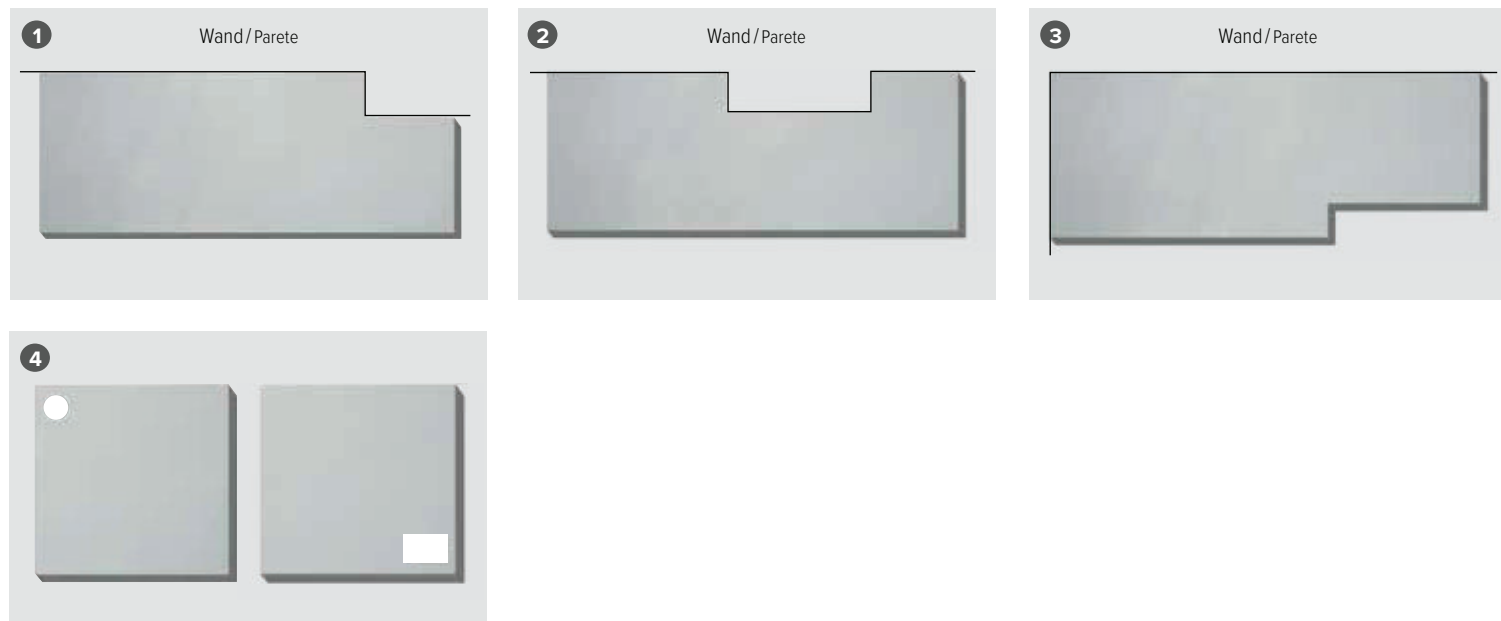

i Für versenkbare Steckdosen, Bedienelemente, Lüftungöffnungen oder Beleuchtungen.
 Per prese a scomparsa, comandi, griglie di ventilazione o luci.

Ausschnitt Intaglio	Erhältlich für Oberfläche Disponibile per superficie	SmartSteel Collection			SolidSteel Collection	
		Kanten Bordi	Zarge Telaio	Geschnitten Tagliato	Geschnitten Tagliato	Geschliffen Rettificato
1 Eckausschnitt wandseitig Intaglio angolare lato parete	Standard SF BF WF	✓	✓	✓	✓	-
	Decor PS PB TR Varix BX	-	-	✓	-	-
	Spezial ID BI BP PL XI XF XB SL WG	-	-	-	✓	-
2 Wandseitiger Ausschnitt Intaglio lato parete	Standard SF BF WF	✓	✓	✓	✓	-
	Decor PS PB TR Varix BX	-	-	✓	-	-
	Spezial ID BI BP PL XI XF XB SL WG	-	-	-	✓	-
3 Frontseitiger Ausschnitt Intaglio lato frontale	Standard SF BF WF	✓	-	-	✓	✓
	Spezial ID BI BP PL XI XF XB SL WG	-	-	-	✓	✓
4 Ausschnitt rund oder eckig Intaglio rotondo o angolare	Standard SF BF WF	✓	✓	✓	✓	-
	Decor PS PB TR Varix BX	-	-	✓	-	-
	Spezial ID BI BP PL XI XF XB SL WG	-	-	-	✓	-

i Standardoberfläche Seidenmatt-Finish für die Ausführung SolidSteel Collection nicht erhältlich.
 Nella versione SolidSteel Collection, la superficie standard con finitura satinata non è disponibile.

Standardoberflächen / Superfici standard

SF	Seidenmatt-Finish / Finitura satinata
BF	Breitband-Finish / Finitura a nastro largo
BX	Breitband Varix / Nastro largo Varix
WF	Wirbel-Finish / Finitura a turbino

Decor Oberflächen / Superfici Decor

PS	Polaris Silver
PB	Polaris Black
TR	Terra

Spezialoberflächen / Superfici speciali

ID	IceDesign™	PL	Polar Look	XB	Xrange Black
BI	BlackRange Industrial	XI	Xrange Ice	SL	Silk Look
BP	BlackRange Passion	XF	Xrange Finline	WG	Warmgewalzt Laminazione a caldo

Alle Massangaben in mm
 Unità di misura in mm

Schrägen/Tagli inclinati

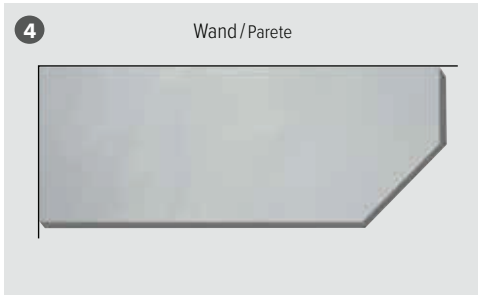
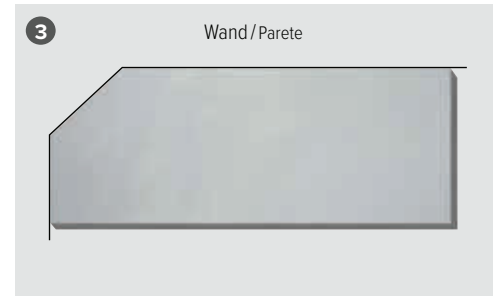
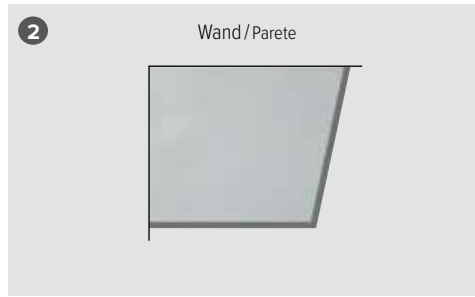
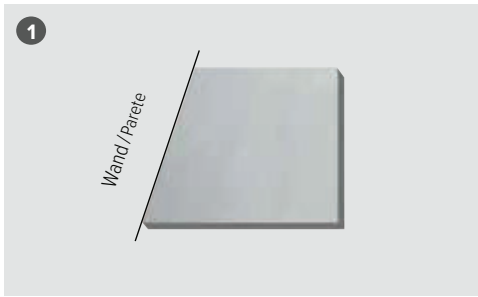

Schräge Taglio inclinato	Erhältlich für Oberfläche Disponibile per superficie	SmartSteel Collection			SolidSteel Collection	
		Kanten Bordi	Zarge Telaio	Geschnitten Tagliato	Geschnitten Tagliato	Geschliffen Rettificato
1 Wandseitig offener oder geschlossener Winkel Angolo aperto o chiuso lato parete	Standard SF BF WF	✓	✓	✓	✓	-
	Decor PS PB TR Varix BX	✓	-	✓	-	-
	Spezial ID BI BP PL XI XF XB SL WG	-	-	-	✓	-
2 Frontseitig offener oder geschlossener Winkel Angolo aperto o chiuso lato frontale	Standard SF BF WF	✓	-	-	✓	✓
	Decor PS PB TR Varix BX	✓	-	-	-	-
	Spezial ID BI BP PL XI XF XB SL WG	-	-	-	✓	✓
3 Eckschräge wandseitig Taglio inclinato angolare lato parete	Standard SF BF WF	✓	✓	✓	✓	-
	Decor PS PB TR Varix BX	-	-	✓	-	-
	Spezial ID BI BP PL XI XF XB SL WG	-	-	-	✓	-
4 Eckschräge frontseitig Taglio inclinato angolare lato frontale	Standard SF BF WF	✓	-	-	✓	✓
	Spezial ID BI BP PL XI XF XB SL WG	-	-	-	✓	✓

i Standardoberfläche Seidenmatt-Finish für die Ausführung SolidSteel Collection nicht erhältlich.
Nella versione SolidSteel Collection, la superficie standard con finitura satinata non è disponibile.

Standardoberflächen / Superfici standard

SF	Seidenmatt-Finish / Finitura satinata
BF	Breitband-Finish / Finitura a nastro largo
BX	Breitband Varix / Nastro largo Varix
WF	Wirbel-Finish / Finitura a turbino

Decor Oberflächen / Superfici Decor

PS	Polaris Silver
PB	Polaris Black
TR	Terra

Spezialoberflächen / Superfici speciali

ID	IceDesign™	PL	Polar Look	XB	Xrange Black
BI	BlackRange Industrial	XI	Xrange Ice	SL	Silk Look
BP	BlackRange Passion	XF	Xrange Finline	WG	Warmgewalzt Laminazione a caldo

Alle Massangaben in mm
Unità di misura in mm

Rundungen / Curvatura

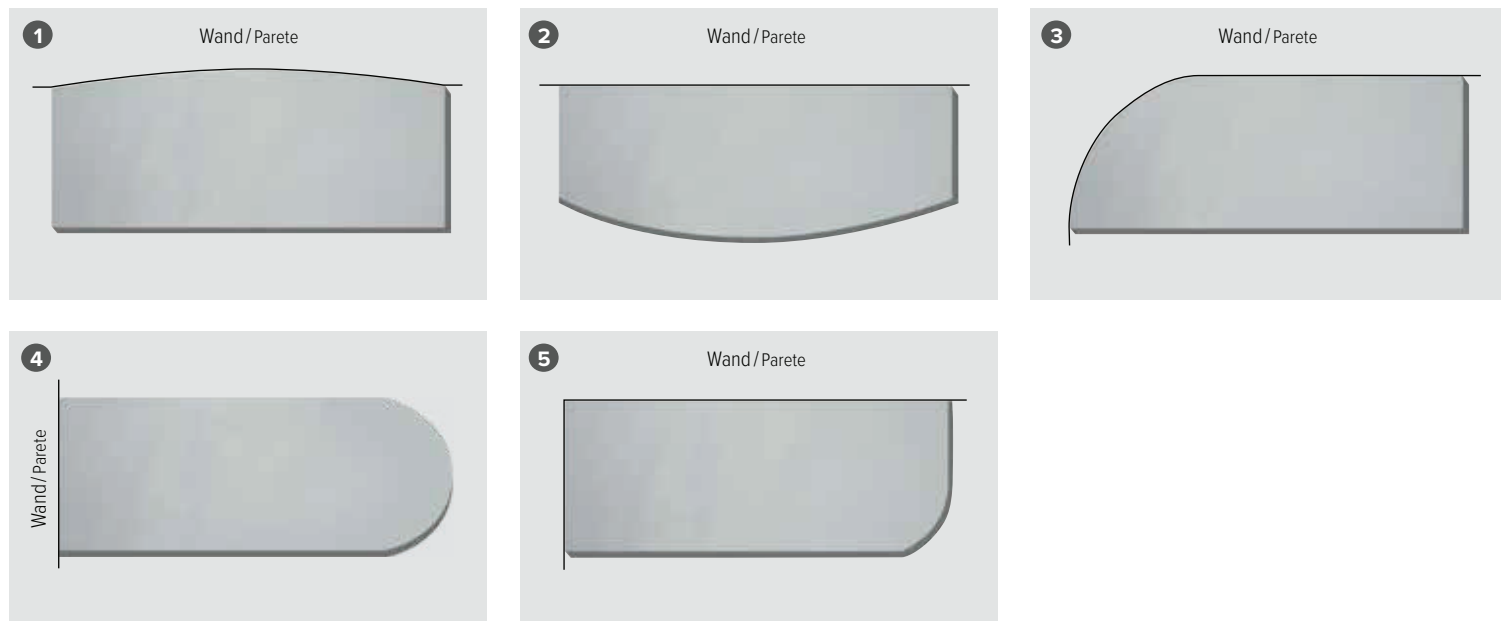

Rundung Curvatura	Erhältlich für Oberfläche Disponibile per superficie	SmartSteel Collection			SolidSteel Collection	
		Kanten Bordi	Zarge Telaio	Geschnitten Tagliato	Geschnitten Tagliato	Geschliffen Rettificato
1 Flache Rundung wandseitig Curvatura piatta lato parete	Standard SF BF WF	✓	-	✓	✓	-
	Decor PS PB TR Varix BX	-	-	✓	-	-
	Spezial ID BI BP PL XI XF XB SL WG	-	-	-	✓	-
2 Flache Rundung frontseitig Curvatura piatta lato frontale	Standard SF BF WF	✓	-	-	✓	✓
	Spezial ID BI BP PL XI XF XB SL WG	-	-	-	✓	✓
3 Wandseitig abgerundet Curvatura lato parete	Standard SF BF WF	✓	-	✓	✓	-
	Decor PS PB TR Varix BX	-	-	✓	-	-
	Spezial ID BI BP PL XI XF XB SL WG	-	-	-	✓	-
4 Ganze Rundung stirnseitig Stondatura completa frontale	Standard SF BF WF	✓	-	-	✓	✓
	Spezial ID BI BP PL XI XF XB SL WG	-	-	-	✓	✓
5 Halbe Rundung frontseitig Semi-stondatura frontale	Standard SF BF WF	✓	-	-	✓	✓
	Spezial ID BI BP PL XI XF XB SL WG	-	-	-	✓	✓

i Standardoberfläche Seidenmatt-Finish für die Ausführung SolidSteel Collection nicht erhältlich.
Nella versione SolidSteel Collection, la superficie standard con finitura satinata non è disponibile.

Standardoberflächen / Superfici standard

SF	Seidenmatt-Finish / Finitura satinata
BF	Breitband-Finish / Finitura a nastro largo
BX	Breitband Varix / Nastro largo Varix
WF	Wirbel-Finish / Finitura a turbino

Decor Oberflächen / Superfici Decor

PS	Polaris Silver
PB	Polaris Black
TR	Terra

Spezialoberflächen / Superfici speciali

ID	IceDesign™	PL	Polar Look	XB	Xrange Black
BI	BlackRange Industrial	XI	Xrange Ice	SL	Silk Look
BP	BlackRange Passion	XF	Xrange Finline	WG	Warmgewalzt Laminazione a caldo

Alle Massangaben in mm
Unità di misura in mm

Verbindung von mehrteiligen Oberflächen / Giunzione di superfici in più parti

Stecknaht «Easy» / Giunto a innesto «Easy»

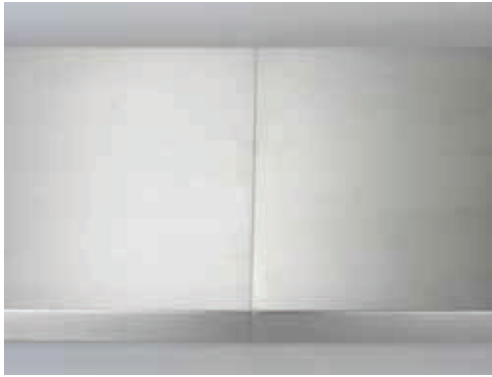

Erhältliche Ausführung / Lavorazione disponibile

SmartSteel Collection

SolidSteel Collection

Weitere Produktinformationen / Altre informazioni prodotto



Erhältliche Oberflächen / Superfici disponibili

Standard

SF BF WF

Decor

PS PB TR

Weitere Produktinformationen / Altre informazioni prodotto

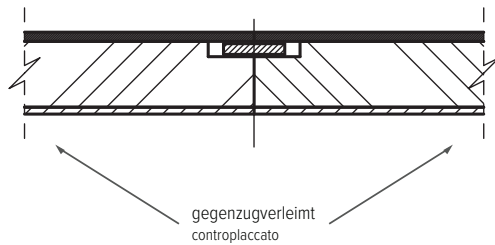

Für Kantenhöhen A12 – A100 erhältlich. Die Stecknaht ist bauseits gut abzustützen. Positionierung der Nahtstelle nach Vorgaben im freien Winkel oder in der Gehrung möglich. Feder für Verbindung wird lose mitgeliefert.

Disponibile per altezze di bordo A12 – A100. Il giunto ad innesto dev'essere supportato in loco nel miglior. Possibile posizionamento del punto di giunzione come da specifica, ad angolo aperto o nello smusso. La linguetta per il collegamento viene fornita sfusa.

Standardoberflächen / Superfici standard

SF	Seidenmatt-Finish / Finitura satinata
BF	Breitband-Finish / Finitura a nastro largo
BX	Breitband Varix / Nastro largo Varix
WF	Wirbel-Finish / Finitura a turbino

Decor Oberflächen / Superfici Decor

PS	Polaris Silver
PB	Polaris Black
TR	Terra

Spezialoberflächen / Superfici speciali

ID	IceDesign™	PL	Polar Look	XB	Xrange Black
BI	BlackRange Industrial	XI	Xrange Ice	SL	Silk Look
BP	BlackRange Passion	XF	Xrange Fineline	WG	Warmgewalzt Laminazione a caldo

Alle Massangaben in mm
Unità di misura in mm

Stecknaht «Stabilo» / Giunto a innesto «Stabilo»

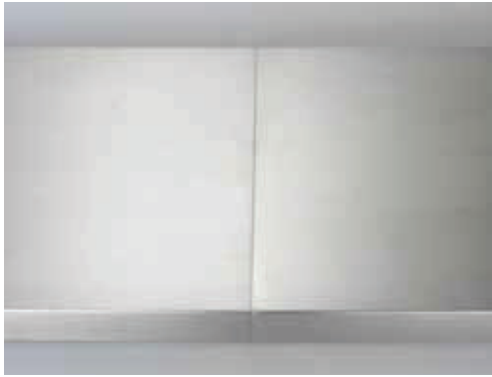

Erhältliche Ausführung / Lavorazione disponibile

SmartSteel Collection



SolidSteel Collection



Weitere Produktinformationen / Altre informazioni prodotto



Erhältliche Oberflächen / Superfici disponibili

Standard

 SF
 BF
 BX
 WF

Decor

 PS
 PB
 TR

Weitere Produktinformationen / Altre informazioni prodotto

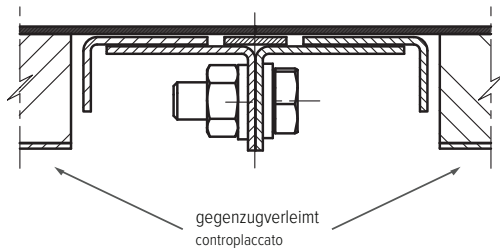

Für Kantenhöhen A20 – A100 erhältlich. Die Stecknaht ist bauseits gut abzustützen. Die Schrauben sind nur leicht anzustellen. Positionierung der Nahtstelle nach Vorgaben im freien Winkel oder in der Gehrung möglich. Feder für Verbindung wird lose mitgeliefert.

Disponibile per altezze di bordo A20 – A100. Il giunto ad innesto dev'essere supportato in loco. Le viti devono essere serrate solo leggermente. Possibile posizionamento del punto di giunzione come da specifica, ad angolo aperto o nello smusso. La linguetta per il collegamento viene fornita sfusa.

Standardoberflächen / Superfici standard

SF	Seidenmatt-Finish / Finitura satinata
BF	Breitband-Finish / Finitura a nastro largo
BX	Breitband Varix / Nastro largo Varix
WF	Wirbel-Finish / Finitura a turbino

Decor Oberflächen / Superfici Decor

PS	Polaris Silver
PB	Polaris Black
TR	Terra

Spezialoberflächen / Superfici speciali

ID	IceDesign™	PL	Polar Look	XB	Xrange Black
BI	BlackRange Industrial	XI	Xrange Ice	SL	Silk Look
BP	BlackRange Passion	XF	Xrange Finline	WG	Warmgewalzt Laminazione a caldo

Alle Massangaben in mm
Unità di misura in mm

Stossverbindungen / Giunti di testa



Erhältliche Ausführung / Lavorazione disponibile

SmartSteel Collection SolidSteel Collection

Weitere Produktinformationen / Altre informazioni prodotto 38

Erhältliche Oberflächen / Superfici disponibili

Standard BF WF
Spezial ID BI BP PL XI XF XB SL WG

Weitere Produktinformationen / Altre informazioni prodotto 32+34

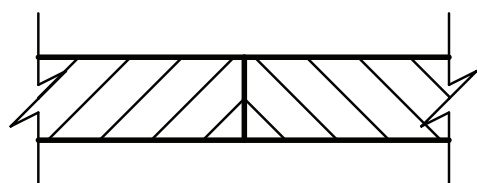

i Die Stossverbindung ist bauseits gut abzustützen und spaltfrei zusammenzufügen. Positionierung der Nahtstelle nach Vorgaben im freien Winkel oder in der Gehrung möglich.
Il giunto di testa dev'essere supportato in loco e il collegamento va effettuato senza fessure. Possibile posizionamento del punto di giunzione come da specifica, ad angolo aperto o nello smusso.

Steckverbindungen / Giunti ad innesto

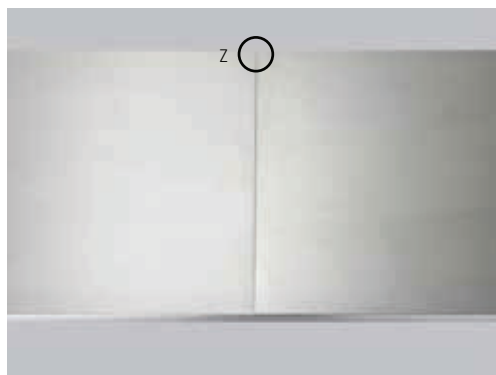

Erhältliche Ausführung / Lavorazione disponibile

SmartSteel Collection SolidSteel Collection

Weitere Produktinformationen / Altre informazioni prodotto 38

Erhältliche Oberflächen / Superfici disponibili

Standard BF WF
Spezial ID BI BP PL XB SL WG

Weitere Produktinformationen / Altre informazioni prodotto 32+34

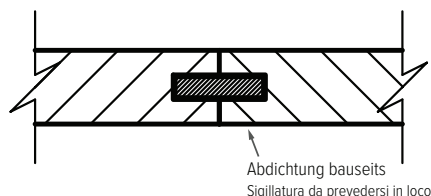

Detail Z / Dettaglio a Z

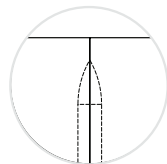

i Nur für Kantenhöhe 8 mm erhältlich. Die Stossverbindung ist bauseits gut abzustützen und spaltfrei zusammenzufügen. Positionierung der Nahtstelle nach Vorgaben im freien Winkel oder in der Gehrung möglich.
Disponibile solo per altezza di bordo 8 mm. Il giunto di testa dev'essere supportato in loco e il collegamento va effettuato senza fessure. Possibile posizionamento del punto di giunzione come da specifica, ad angolo aperto o nello smusso.

Standardoberflächen / Superfici standard

SF	Seidenmatt-Finish / Finitura satinata
BF	Breitband-Finish / Finitura a nastro largo
BX	Breitband Varix / Nastro largo Varix
WF	Wirbel-Finish / Finitura a turbino

Decor Oberflächen / Superfici Decor

PS	Polaris Silver
PB	Polaris Black
TR	Terra

Spezialoberflächen / Superfici speciali

ID	IceDesign™	PL	Polar Look	XB	Xrange Black
BI	BlackRange Industrial	XI	Xrange Ice	SL	Silk Look
BP	BlackRange Passion	XF	Xrange Finline	WG	Warmgewalzt Laminazione a caldo

Alle Massangaben in mm
Unità di misura in mm



Sortiment nach Unterschrankmassen

Assortimento per dimensioni di base **138**

Edelstahl/Acciaio inox

Linero

LIO 18U + LIO 34U	140
LIO 40U	141
LIO 45U	142
LIO 50U	143
LIO 55U	144

Daneo

DAN 18U + DAN 34U	146 – 147
DAN 40U	148 – 149
DAN 45U	150 – 151
DAN 50U	152 – 153
DAN 55U	154 – 155

Vantis

V 34U	156 – 157
V 40U	158 – 159
V 45U	160 – 161
V 50-42U	162 – 163
V 50-35U + V 11U	164 – 165
V 55U	166 – 167
VX 34U Varix	168
VX 40U Varix	169
VX 45U Varix	170
VX 50-42U Varix	171
VX 55U Varix	172

Silver Star

SIL 18U + SIL 34U	174
SIL 18/34U	176
SIL 45U	178
SIS 50U	179
SIL 50U + SIL 9U	180
SIL 55U	182
SX 40U Varix	183
SX 50-42U Varix	184

Comfort

COM 34U	185
COM 40U	186

Accento

A 65U	187
A 75U	188
A 40/34U	189

Gastro MaXX

MGM 1U + MGM 2U	190
-----------------	------------

Rund

R 44BU	190
--------	------------

Granit (Cristadur)

Granito (Cristadur)

Linero

LIO CD 50U	192
LIO CDAB 50U	194

Granit (Cristalite Plus)

Granito (Cristalite Plus)

Daneo

DAN CP 45U	196
DAN CP 50U/1 / DAN CP 50U/2	198
DAN CP 55U	200

Brooklyn

BYK N 100S U	202
BYKAB N 100S U Black Edition	203
BYK N 100U	204
BYKAB N 100U Black Edition	205
BYK N 100L U	206
BYKAB N 100L U Black Edition	207

Quadro

QUA N 100	208
-----------	------------

Carbon / Carbone

Carbon

CAR N 100U	209
------------	------------

Montagematerial/Materiale per il montaggio





























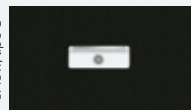





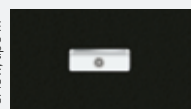







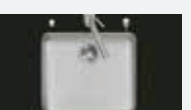







Befestigungsklammern für Unterbau-Becken
Staffe di fissaggio per lavelli sottopiano
40.000.437.00





Befestigungsklammern für Unterbau-Becken Schock Granitspülen
Staffe di fissaggio per lavelli sottopiano in granito Schock
40.002.461.00

Sortiment nach Unterschrankmassen / Assortimento per dimensioni di base

	35cm	40cm	45cm	50cm	55cm
Linero sFlow, Typ M sFlow, tipo M	 Linero: LIO 18U 140	 Linero: LIO 34U 140	 Linero: LIO 40U 141	 Linero: LIO 45U 142	 Linero: LIO 50U 143
					 Linero: LIO CD 50U/2 192
Daneo sFlow, Typ S sFlow, tipo S	 Daneo: DAN 18U 146	 Daneo: DAN 34U 146	 Daneo: DAN 40U 148	 Daneo: DAN 45U 150	 Daneo: DAN 50U 152
					 Daneo: DAN CP 45U 196
Daneo sFlow, Typ M sFlow, tipo M	 Daneo: DAN 18U 147	 Daneo: DAN 34U 147	 Daneo: DAN 40U 149	 Daneo: DAN 45U 151	 Daneo: DAN 50U 153
					 Daneo: DAN CP 50U/2 198
Vantis sFlow, Typ S sFlow, tipo S	 Vantis: V 11U 164	 Vantis: V 34U 156	 Vantis: V 40U 158	 Vantis: V 45U 160	 Vantis: V 50-42U 162
					 Vantis: V 50-35U Vantis: V 50-35U + V 11U 164
Vantis sFlow, Typ M sFlow, tipo M	 Vantis: V 11U 165	 Vantis: V 34U 157	 Vantis: V 40U 159	 Vantis: V 45U 161	 Vantis: V 50-42U 163
		 Vantis: VX 34U Varix 168	 Vantis: VX 40U Varix 169	 Vantis: VX 45U Varix 170	 Vantis: VX 50-42U Varix 171
Silver Star	 Silver Star: SIL 9U 180	 Silver Star: SIL 34U 174		 Silver Star: SIL 45U 178	 Silver Star: SIS 50U 179
	 Silver Star: SIL 18U 174		 Silver Star: SX 40U Varix 183		 Silver Star: SX 50-42U Varix 184
Comfort / Accento		 Comfort: COM 34U 185	 Comfort: COM 40U 186		
Einzel-Becken Lavelli a vasca singola		 Rund: R 44BU 190	 Brooklyn: BYK N 100S U 202	 Brooklyn: BYK N 100U 204	
			 Brooklyn: BYKAB N 100S U 202	 Brooklyn: BYKAB N 100U 205	

 eFlow mit eControl
eFlow con eControl

 Schwenkbare Überlaufkappe
Placchetta di troppopieno a ribalta

 Desino: Verdeckter Ablauf mit untenliegendem Sieb
Desino: Scarico coperto con griglietta inferiore

60cm

80cm



Linero: LIO 18U + LIO 34U  140

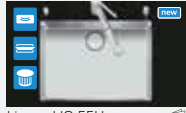

Linero: LIO 55U  144



Linero: LIO CD 50U/1  192

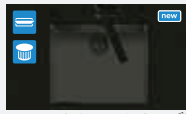

Linero: LIO CDAB 50U/1  194



Daneo: DAN 18U + DAN 34U  146



Daneo: DAN 55U  154



Daneo: DAN 18U + DAN 34U  147



Daneo: DAN 55U  155



Daneo: DAN CP 50U/1  198



Daneo: DAN CP 55U  200



Vantis: V 55U  166



Vantis: V 55U  167



Vantis: VX 55U Varix  172



Silver Star: SIL 18U + SIL 34U  174



Silver Star: SIL 55U  182



Silver Star: SIL 18/34U  176



Accento: A 65U  187



Accento: A 40/34U  189



Quadro: QUA N 100  208



Brooklyn: BYK N 100L U  206



Carbon: CAR N 100U  209



Brooklyn: BYKAB N 100L U  207

Linero: LIO 18U + LIO 34U

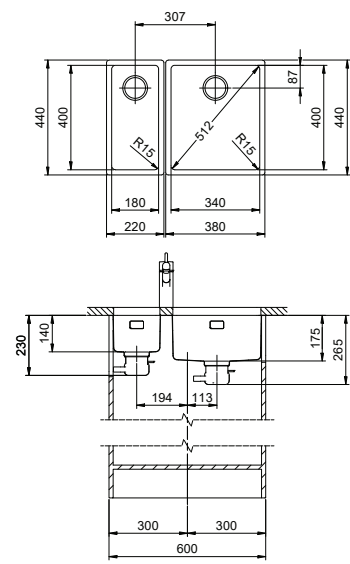

eFlow mit eControl
eFlow con eControl

Schwenkbare Überlaufkappe
Placchetta di troppopieno a ribalta

Desino: Verdeckter Ablauf mit untenliegendem Sieb
Desino: Scarico coperto con griglietta inferiore



Für eFlow Desino
Per eFlow Desino



Für TouchFlow Desino und Raumspaar Desino
Per TouchFlow Desino e Salvaspazio Desino



Für eFlow Desino, TouchFlow Desino und Raumspaar Desino
Per eFlow Desino, TouchFlow Desino e Salvaspazio Desino

Optionales Zubehör / Accessori opzionali



Resteschale gelocht
Vaschetta forato
CHF 106.– 40.000.912.00



Resteschale ungelocht
Vaschetta non forato
CHF 106.– 40.001.289.00

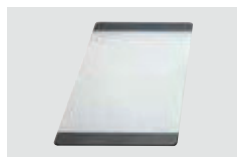

Schneidebrett aus Glas
Tagliere in vetro
CHF 151.– 40.000.909.00



Schneidebrett aus Kunststoff
Tagliere sintetico
CHF 151.– 40.001.277.00

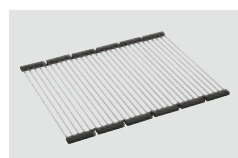

Inox Pad
CHF 125.– 40.001.138.00

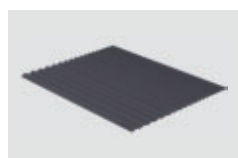

Maro Abtropfmatte aus Silikon
Maro tappetino scolapiatti in silicone
CHF 51.– 40.002.008.00

Zeichnung als pdf / dxf und Montageanleitung siehe:
V. disegno in formato pdf / dxf e montaggio:
suter.ch

Kombination LIO 18U + LIO 34U:
Erfordert beidseitigen Ausschnitt der Korpuswand, bei LIO 18U mit vergrössertem Ausschnitt.
Combinazione LIO 18U + LIO 34U:
Richiede un intaglio della parete dell'armadio su entrambi i lati, per LIO 18U un intaglio allargato.

Preis CHF/Prezzo in CHF

Modell Modello	Material Materiale	Ventil sFlow, Typ M Piletta sFlow, tipo M	Artikel-Nr. N. di articolo	Beckentiefe Profondità	Exkl. MWST IVA esclusa	Inkl. MWST IVA inclusa	VRG TRA
Linero LIO 18U	Edelstahl, matt Acciaio inox, opaco	18/10	3 1/2" eFlow Desino	10.105.216.00	140 mm	A 1285.–	1389.– 0.19
			3 1/2" TouchFlow Desino	10.105.217.00	140 mm	A 1170.–	1265.– 0.19
Linero LIO 34U	Edelstahl, matt Acciaio inox, opaco	18/10	3 1/2" eFlow Desino	10.105.218.00	175 mm	A 1548.–	1673.– 0.19
			3 1/2" TouchFlow Desino	10.105.219.00	175 mm	A 1433.–	1549.– 0.19
			3 1/2" Raumspaar Desino Salvaspazio Desino	10.105.220.00	175 mm	A 1223.–	1322.–
Linero LIO 18U + Linero LIO 34U	Edelstahl, matt Acciaio inox, opaco	18/10	3 1/2" eFlow Desino + eFlow Desino	10.105.286.00	140 mm 175 mm	A 2748.–	2971.– 0.19
			3 1/2" TouchFlow Desino + TouchFlow Desino	10.105.287.00	140 mm 175 mm	A 2525.–	2730.– 0.19

Linero: LIO 40U

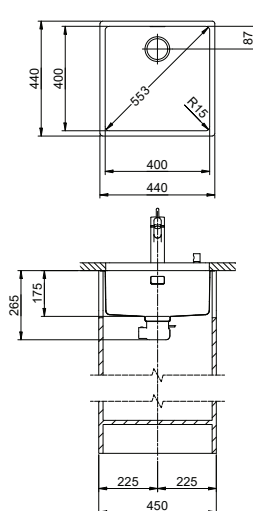

eFlow mit eControl
eFlow con eControl



Schwenkbare Überlaufkappe
Placchetta di troppopieno a ribalta



Desino: Verdeckter Ablauf mit untenliegendem Sieb
Desino: Scarico coperto con griglietta inferiore



Für eFlow Desino
Per eFlow Desino



Für TouchFlow Desino und Raumspaar Desino
Per TouchFlow Desino e Salvaspazio Desino



Für eFlow Desino, TouchFlow Desino und Raumspaar Desino
Per eFlow Desino, TouchFlow Desino e Salvaspazio Desino

Optionales Zubehör / Accessori opzionali



Resteschale gelocht
Vaschetta forato
CHF 106.– 40.000.912.00



Resteschale ungelocht
Vaschetta non forato
CHF 106.– 40.001.289.00

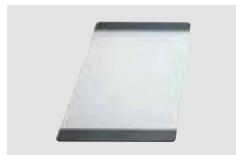

Schneidebrett aus Glas
Tagliere in vetro
CHF 151.– 40.000.909.00



Schneidebrett aus Kunststoff
Tagliere sintetico
CHF 151.– 40.001.277.00

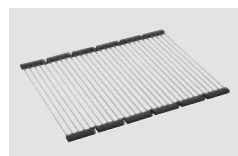

Inox Pad
CHF 125.– 40.001.138.00

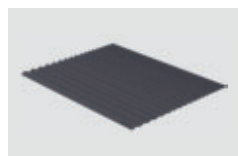

Maro Abtropfmatte aus Silikon
Maro tappetino scolapiatti in silicone
CHF 51.– 40.002.008.00

Zeichnung als pdf/dxf und Montageanleitung siehe:
V. disegno in formato pdf/dxf e montaggio:
suter.ch

Preis CHF/Prezzo in CHF

Modell Modello	Material Materiale	Ventil sFlow, Typ M Piletta sFlow, tipo M	Artikel-Nr. N. di articolo	Beckentiefe Profondità	Exkl. MWST IVA esclusa	Inkl. MWST IVA inclusa	VRG TRA
Linero LIO 40U	Edelstahl, matt Acciaio inox, opaco	3 1/2" eFlow Desino	10.105.221.00	175 mm	1609.–	1739.–	0.19
		3 1/2" TouchFlow Desino	10.105.222.00	175 mm	1494.–	1615.–	0.19
		3 1/2" Raumspaar Desino Salvaspazio Desino	10.105.223.00	175 mm	1284.–	1388.–	

Linero: LIO 45U

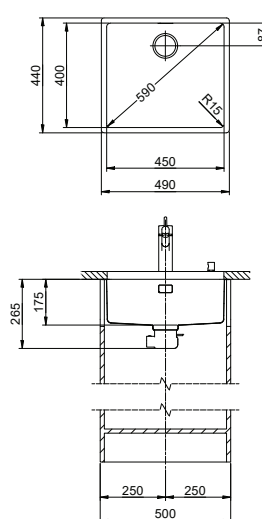

eFlow mit eControl
eFlow con eControl



Schwenkbare Überlaufkappe
Placchetta di troppopieno a ribalta



Desino: Verdeckter Ablauf mit untenliegendem Sieb
Desino: Scarico coperto con griglietta inferiore



Für eFlow Desino
Per eFlow Desino



Für TouchFlow Desino und Raumspaar Desino
Per TouchFlow Desino e Salvaspazio Desino



Für eFlow Desino, TouchFlow Desino und Raumspaar Desino
Per eFlow Desino, TouchFlow Desino e Salvaspazio Desino

Optionales Zubehör / Accessori opzionali



Resteschale gelocht
Vaschetta forato
CHF 106.– 40.000.912.00



Resteschale ungelocht
Vaschetta non forato
CHF 106.– 40.001.289.00

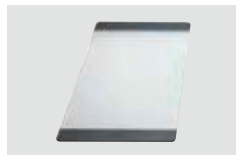

Schneidebrett aus Glas
Tagliere in vetro
CHF 151.– 40.000.909.00



Schneidebrett aus Kunststoff
Tagliere sintetico
CHF 151.– 40.001.277.00

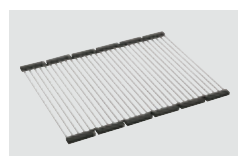

Inox Pad
CHF 125.– 40.001.138.00

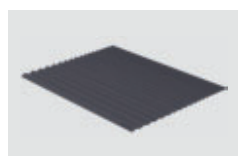

Maro Abtropfmatte aus Silikon
Maro tappetino scolapiatti in silicone
CHF 51.– 40.002.008.00

Zeichnung als pdf / dxf und Montageanleitung siehe:
V. disegno in formato pdf / dxf e montaggio:
suter.ch

Preis CHF / Prezzo in CHF

Modell Modello	Material Materiale	Ventil sFlow, Typ M Piletta sFlow, tipo M	Artikel-Nr. N. di articolo	Beckentiefe Profondità	Exkl. MWST IVA esclusa	Inkl. MWST IVA inclusa	VRG TRA			
Linero LIO 45U	Edelstahl, matt Acciaio inox, opaco	18/10	3 1/2" eFlow Desino	10.105.224.00	L	175 mm	A	1633.–	1765.–	0.19
		3 1/2" TouchFlow Desino	10.105.225.00	L	175 mm	A	1518.–	1641.–	0.19	
		3 1/2" Raumspaar Desino Salvaspazio Desino	10.105.226.00	L	175 mm	A	1308.–	1414.–		

Linero: LIO 50U

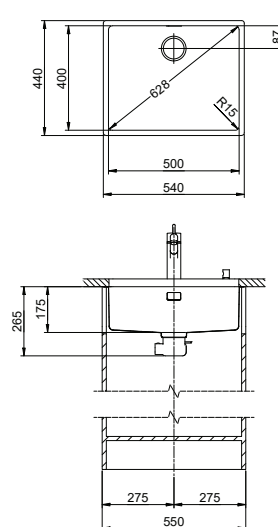

eFlow mit eControl
eFlow con eControl

27

Schwenkbare Überlaufkappe
Placchetta di troppopieno a ribalta

27

Desino: Verdeckter Ablauf mit untenliegendem Sieb
Desino: Scarico coperto con griglietta inferiore

26



Für eFlow Desino
Per eFlow Desino



Für TouchFlow Desino und Raumspar Desino
Per TouchFlow Desino e Salvaspazio Desino



Für eFlow Desino, TouchFlow Desino und Raumspar Desino
Per eFlow Desino, TouchFlow Desino e Salvaspazio Desino

Optionales Zubehör / Accessori opzionali

310



Resteschale gelocht
Vaschetta forato
CHF 106.– 40.000.912.00



Resteschale ungelocht
Vaschetta non forato
CHF 106.– 40.001.289.00

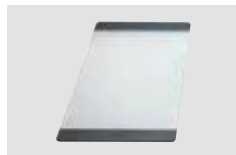

Schneidebrett aus Glas
Tagliere in vetro
CHF 151.– 40.000.909.00



Schneidebrett aus Kunststoff
Tagliere sintetico
CHF 151.– 40.001.277.00

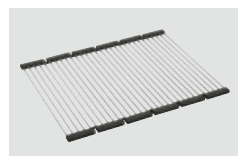

Inox Pad
CHF 125.– 40.001.138.00

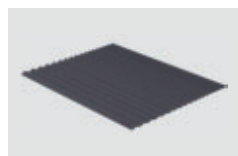

Maro Abtropfmatte aus Silikon
Maro tappetino scolapiatti in silicone
CHF 51.– 40.002.008.00

Zeichnung als pdf / dxf und Montageanleitung siehe:
V. disegno in formato pdf / dxf e montaggio:
suter.ch

Preis CHF/Prezzo in CHF

Modell Modello	Material Materiale	Ventil sFlow, Typ M Piletta sFlow, tipo M	Artikel-Nr. N. di articolo	Beckentiefe Profondità	Exkl. MWST IVA esclusa	Inkl. MWST IVA inclusa	VRG TRA
Linero LIO 50U	Edelstahl, matt Acciaio inox, opaco	18/10	3 1/2" eFlow Desino	10.105.227.00	175 mm	A 1656.–	1790.– 0.19
			3 1/2" TouchFlow Desino	10.105.228.00	175 mm	A 1541.–	1666.– 0.19
			3 1/2" Raumspar Desino Salvaspazio Desino	10.105.229.00	175 mm	A 1331.–	1439.–

Linero: LIO 55U

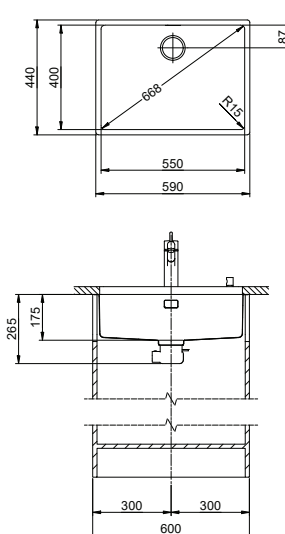

eFlow mit eControl
eFlow con eControl



Schwenkbare Überlaufkappe
Placchetta di troppopieno a ribalta



Desino: Verdeckter Ablauf mit untenliegendem Sieb
Desino: Scarico coperto con griglietta inferiore



Für eFlow Desino
Per eFlow Desino



Für TouchFlow Desino und Raumspar Desino
Per TouchFlow Desino e Salvaspazio Desino



Für eFlow Desino, TouchFlow Desino und Raumspar Desino
Per eFlow Desino, TouchFlow Desino e Salvaspazio Desino

Optionales Zubehör / Accessori opzionali



Resteschale gelocht
Vaschetta forato
CHF 106.– 40.000.912.00



Resteschale ungelocht
Vaschetta non forato
CHF 106.– 40.001.289.00

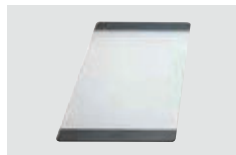

Schneidebrett aus Glas
Tagliere in vetro
CHF 151.– 40.000.909.00



Schneidebrett aus Kunststoff
Tagliere sintetico
CHF 151.– 40.001.277.00

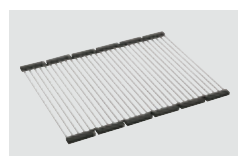

Inox Pad
CHF 125.– 40.001.138.00

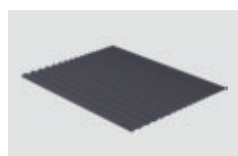

Maro Abtropfmatte aus Silikon
Maro tappetino scolapiatti in silicone
CHF 51.– 40.002.008.00

Zeichnung als pdf / dxf und Montageanleitung siehe:
V. disegno in formato pdf / dxf e montaggio:
suter.ch

Preis CHF / Prezzo in CHF

Modell Modello	Material Materiale	Ventil sFlow, Typ M Piletta sFlow, tipo M	Artikel-Nr. N. di articolo	Beckentiefe Profondità	Exkl. MWST IVA esclusa	Inkl. MWST IVA inclusa	VRG TRA		
Linero LIO 55U	Edelstahl, matt Acciaio inox, opaco	18/10	3 1/2" eFlow Desino	10.105.230.00	175 mm	A	1740.–	1881.–	0.19
		3 1/2" TouchFlow Desino	10.105.231.00	175 mm	A	1625.–	1757.–	0.19	
		3 1/2" Raumspar Desino Salvaspazio Desino	10.105.232.00	175 mm	A	1415.–	1530.–		



Daneo: DAN 18U + DAN 34U

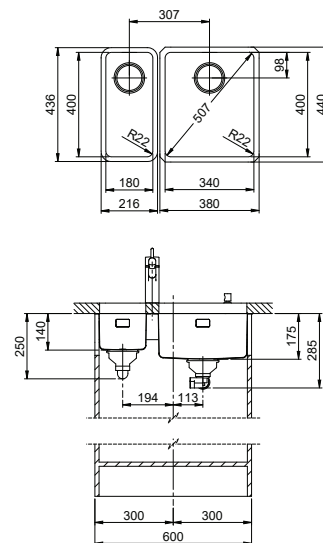

Schwenkbare Überlaufkappe
Placchetta di troppopieno a ribalta

27

Obenliegendes Sieb
Griglietta superiore

26



Zeichnung als pdf/dxf und Montageanleitung siehe:
V. disegno in formato pdf/dxf e montaggio:
suter.ch

Optionales Zubehör / Accessori opzionali

310

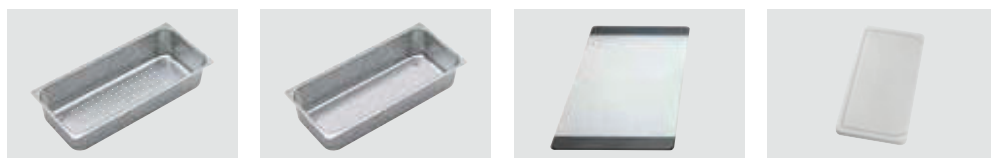

Resteschale gelocht
Vaschetta forata

CHF 106.– 40.000.912.00

Resteschale ungelocht
Vaschetta non forata

CHF 106.– 40.001.289.00

Schneidebrett aus Glas
Tagliere in vetro

CHF 151.– 40.000.909.00

Schneidebrett aus Kunststoff
Tagliere sintetico

CHF 151.– 40.001.277.00

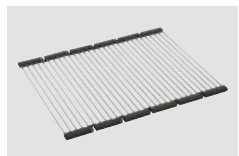

Innox Pad

CHF 125.– 40.001.138.00

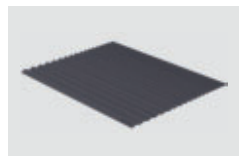

Maro Abtropfmatte aus Silikon
Maro tappetino scolapiatti in silicone

CHF 51.– 40.002.008.00

Varianten: Für das Unterbau-Becken Daneo mit Standard Zugknopf Advant Chrom bestellen Sie

xx.xxx.xx.01 Standardartikel ohne Zugknopf. Reduktion CHF 24.–. Im Austausch wählen Sie den gewünschten Zugknopf auf Seite 358.

Varianti: per il lavello sottopiano Daneo con pomolo standard Advant cromato, ordinate
xx.xxx.xx.01 – Articolo standard senza pomolo. Riduzione di CHF 24.–. In sostituzione, scegliete il pomolo desiderato a pagina 358.

Preis CHF/Prezzo in CHF

Modell Modello	Material Materiale	Ventil sFlow, Typ S Piletta sFlow, tipo S	Artikel-Nr. N. di articolo	Beckentiefe Profondità	Exkl. MWST IVA esclusa	Inkl. MWST IVA inclusa	VRG TRA
Daneo DAN 18U	Edelstahl, matt Acciaio inox, opaco	18/10	3 1/2" Tipo	10.103.806.00	140 mm	A	735.– 795.–
Daneo DAN 34U	Edelstahl, matt Acciaio inox, opaco	18/10	3 1/2" TouchFlow	10.103.789.00	175 mm	A	1220.– 1319.– 0.19
			3 1/2" Raumsparsalvaspazio	10.103.790.00	175 mm	A	1022.– 1105.–
			3 1/2" Tipo	10.103.791.00	175 mm	A	981.– 1060.–
Daneo DAN 18U + Daneo DAN 34U	Edelstahl, matt Acciaio inox, opaco	18/10	3 1/2" Tipo + TouchFlow	10.103.810.00	140 mm 175 mm	A	1902.– 2056.– 0.19
			3 1/2" Tipo + Raumsparsalvaspazio	10.103.811.00	140 mm 175 mm	A	1704.– 1842.–
			3 1/2" Tipo + Tipo	10.103.812.00	140 mm 175 mm	A	1663.– 1798.–

Daneo: DAN 18U + DAN 34U

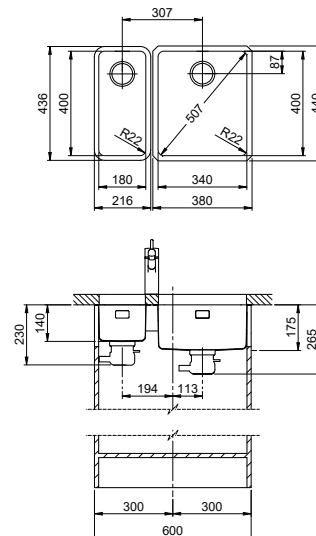

eFlow mit eControl
eFlow con eControl



Schwenkbare Überlaufkappe
Placchetta di troppopieno a ribalta



Desino: Verdeckter Ablauf mit untenliegendem Sieb
Desino: Scarico coperto con griglietta inferiore



Für eFlow Desino
Per eFlow Desino



Für TouchFlow Desino und Raumspaar Desino
Per TouchFlow Desino e Salvaspazio Desino



Für eFlow Desino, TouchFlow Desino und Raumspaar Desino
Per eFlow Desino, TouchFlow Desino e Salvaspazio Desino

Optionales Zubehör / Accessori opzionali



Resteschale gelocht
Vaschetta forato
CHF 106.– 40.000.912.00



Resteschale ungelocht
Vaschetta non forato
CHF 106.– 40.001.289.00



Schneidebrett aus Glas
Tagliere in vetro
CHF 151.– 40.000.909.00



Schneidebrett aus Kunststoff
Tagliere sintetico
CHF 151.– 40.001.277.00

Zeichnung als pdf / dxf und Montageanleitung siehe:
V. disegno in formato pdf / dxf e montaggio:
suter.ch



Kombination DAN 18U + DAN 34U:
Erfordert beidseitigen Ausschnitt der Korpuswand, bei DAN 18U mit vergrößerter Ausschnitt.
Combinazione DAN 18U + DAN 34U:
Richiede un taglio della parete dell'armadio su entrambi i lati, per DAN 18U un taglio allargato.

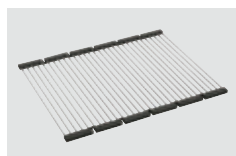

Inox Pad
CHF 125.– 40.001.138.00

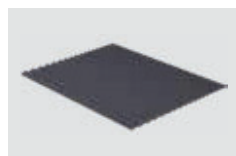

Maro Abtropfmatte aus Silikon
Maro tappetino scolapiatti in silicone
CHF 51.– 40.002.008.00



Varianten: Für das Unterbau-Becken Daneo mit Standard Zugknopf Advant Chrom bestellen Sie

xx.xxx.xx.01 Standardartikel ohne Zugknopf. Reduktion CHF 24.–. Im Austausch wählen Sie den gewünschten Zugknopf auf Seite 358.

Varianti: per il lavello sottopiano Daneo con pomolo standard Advant cromato, ordinate
xx.xxx.xx.01 – Articolo standard senza pomolo. Riduzione di CHF 24.–. In sostituzione, scegliete il pomolo desiderato a pagina 358.

Preis CHF/Prezzo in CHF

Modell Modello	Material Materiale	Ventil sFlow, Typ M Piletta sFlow, tipo M	Artikel-Nr. N. di articolo	Beckentiefe Profondità	Exkl. MWST IVA esclusa	Inkl. MWST IVA inclusa	VRG TRA
Daneo DAN 18U	Edelstahl, matt Acciaio inox, opaco	18/10	3 1/2" eFlow Desino	10.104.663.00	140 mm	1241.–	0.19
			3 1/2" TouchFlow Desino	10.104.631.00	140 mm	1126.–	0.19
Daneo DAN 34U	Edelstahl, matt Acciaio inox, opaco	18/10	3 1/2" eFlow Desino	10.104.664.00	175 mm	1487.–	0.19
			3 1/2" TouchFlow Desino	10.104.632.00	175 mm	1372.–	0.19
			3 1/2" Raumspaar Desino Salvaspazio Desino	10.104.633.00	175 mm	1162.–	
Daneo DAN 18U + Daneo DAN 34U	Edelstahl, matt Acciaio inox, opaco	18/10	3 1/2" eFlow Desino + eFlow Desino	10.105.203.00	140 mm 175 mm	2646.–	0.19
			3 1/2" TouchFlow Desino + TouchFlow Desino	10.105.202.00	140 mm 175 mm	2423.–	0.19

Daneo: DAN 40U

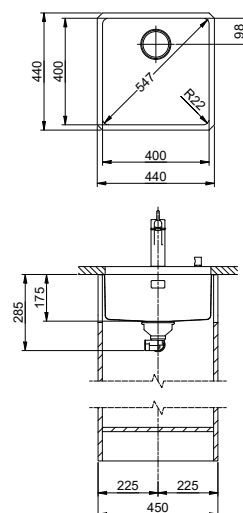

 Schwenkbare Überlaufkappe
Placchetta di troppopieno a ribalta

27

 Obenliegendes Sieb
Griglietta superiore

26



Zeichnung als pdf/dxf und Montageanleitung siehe:
V. disegno in formato pdf/dxf e montaggio:
suter.ch

Optionales Zubehör / Accessori opzionali

310

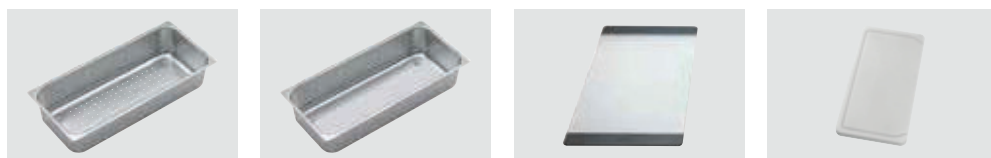

Resteschale gelocht
Vaschetta forata

CHF 106.– 40.000.912.00

Resteschale ungelocht
Vaschetta non forata

CHF 106.– 40.001.289.00

Schneidebrett aus Glas
Tagliere in vetro

CHF 151.– 40.000.909.00

Schneidebrett aus Kunststoff
Tagliere sintetico

CHF 151.– 40.001.277.00

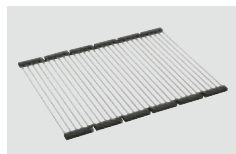

Inox Pad

CHF 125.– 40.001.138.00

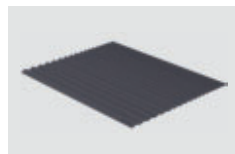

Maro Abtropfmatte aus Silikon
Maro tappetino scolapiatti in silicone

CHF 51.– 40.002.008.00

 **Varianten: Für das Unterbau-Becken Daneo mit Standard Zugknopf Advant Chrom bestellen Sie**
xx.xxx.xx.01 Standardartikel ohne Zugknopf. Reduktion CHF 24.–. Im Austausch wählen Sie den gewünschten Zugknopf auf Seite 358.
Varianti: per il lavello sottopiano Daneo con pomolo standard Advant cromato, ordinate
xx.xxx.xx.01 – Articolo standard senza pomolo. Riduzione di CHF 24.–. In sostituzione, scegliete il pomolo desiderato a pagina 358.

Preis CHF/Prezzo in CHF

Modell Modello	Material Materiale	Ventil sFlow, Typ S Piletta sFlow, tipo S	Artikel-Nr. N. di articolo	Beckentiefe Profondità	Exkl. MWST IVA esclusa	Inkl. MWST IVA inclusa	VRG TRA		
Daneo DAN 40U	Edelstahl, matt Acciaio inox, opaco	18/10	3 1/2" TouchFlow	10.103.557.00 	175 mm	A	1277.–	1380.–	0.19
			3 1/2" Raumspär Salvaspazio	10.103.558.00 	175 mm	A	1079.–	1166.–	
			3 1/2" Tipo	10.103.559.00 	175 mm	A	1038.–	1122.–	

Daneo: DAN 40U

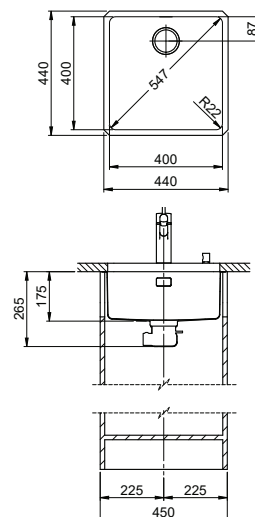

eFlow mit eControl
eFlow con eControl

27

Schwenkbare Überlaufkappe
Placchetta di troppopieno a ribalta

27

Desino: Verdeckter Ablauf mit untenliegendem Sieb
Desino: Scarico coperto con griglietta inferiore

26



Für eFlow Desino
Per eFlow Desino



Für TouchFlow Desino und Raumspars Desino
Per TouchFlow Desino e Salvaspazio Desino



Für eFlow Desino, TouchFlow Desino und Raumspars Desino
Per eFlow Desino, TouchFlow Desino e Salvaspazio Desino

Optionales Zubehör / Accessori opzionali

310



Resteschale gelocht
Vaschetta forato
CHF 106.– 40.000.912.00



Resteschale ungelocht
Vaschetta non forato
CHF 106.– 40.001.289.00

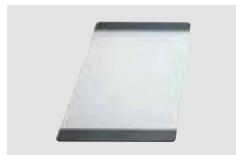

Schneidebrett aus Glas
Tagliere in vetro
CHF 151.– 40.000.909.00



Schneidebrett aus Kunststoff
Tagliere sintetico
CHF 151.– 40.001.277.00

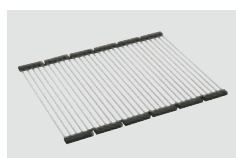

Inox Pad
CHF 125.– 40.001.138.00

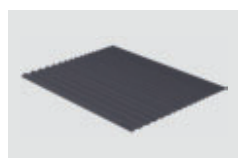

Maro Abtropfmatte aus Silikon
Maro tappetino scolapiatti in silicone
CHF 51.– 40.002.008.00

Zeichnung als pdf / dxf und Montageanleitung siehe:
V. disegno in formato pdf / dxf e montaggio:
suter.ch

Varianten: Für das Unterbau-Becken Daneo mit Standard Zugknopf Advant Chrom bestellen Sie
xx.xxx.xx.01 Standardartikel ohne Zugknopf. Reduktion CHF 24.–. Im Austausch wählen Sie den gewünschten Zugknopf auf Seite 358.
Varianti: per il lavello sottopiano Daneo con pomolo standard Advant cromato, ordinate
xx.xxx.xx.01 – Articolo standard senza pomolo. Riduzione di CHF 24.–. In sostituzione, scegliete il pomolo desiderato a pagina 358.

Preis CHF/Prezzo in CHF

Modell Modello	Material Materiale	Ventil sFlow, Typ M Piletta sFlow, tipo M	Artikel-Nr. N. di articolo	Beckentiefe Profondità	Exkl. MWST IVA esclusa	Inkl. MWST IVA inclusa	VRG TRA
Daneo DAN 40U	Edelstahl, matt Acciaio inox, opaco	18/10	3 1/2" eFlow Desino	10.104.665.00	175 mm	A 1544.–	1669.– 0.19
			3 1/2" TouchFlow Desino	10.104.634.00	175 mm	A 1429.–	1545.– 0.19
			3 1/2" Raumspars Desino Salvaspazio Desino	10.104.635.00	175 mm	A 1219.–	1318.–

Daneo: DAN 45U

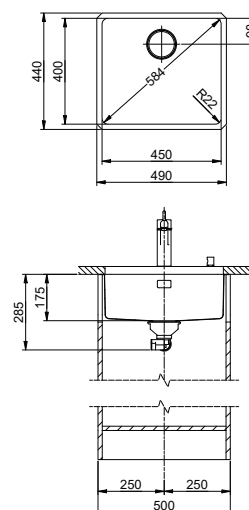

Schwenkbare Überlaufkappe
Placchetta di troppopieno a ribalta

27

Obenliegendes Sieb
Griglietta superiore

26



Zeichnung als pdf/dxf und Montageanleitung siehe:
V. disegno in formato pdf/dxf e montaggio:
suter.ch

Optionales Zubehör / Accessori opzionali

310

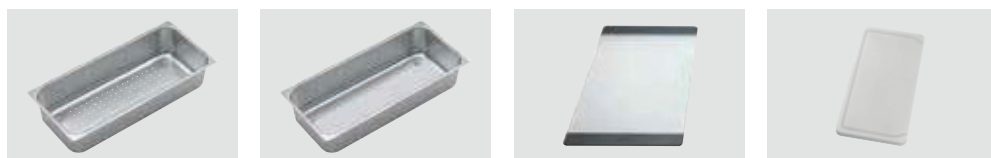

Resteschale gelocht
Vaschetta forato

CHF 106.- 40.000.912.00

Resteschale ungelocht
Vaschetta non forato

CHF 106.- 40.001.289.00

Schneidebrett aus Glas
Tagliere in vetro

CHF 151.- 40.000.909.00

Schneidebrett aus Kunststoff
Tagliere sintetico

CHF 151.- 40.001.277.00

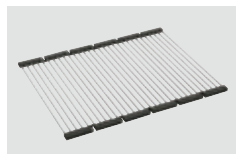

Inox Pad

CHF 125.- 40.001.138.00

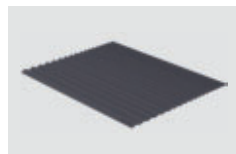

Maro Abtropfmatte aus Silikon
Maro tappetino scolapiatti in silicone

CHF 51.- 40.002.008.00

Varianten: Für das Unterbau-Becken Daneo mit Standard Zugknopf Advant Chrom bestellen Sie
xx.xxx.xx.01 Standardartikel ohne Zugknopf. Reduktion CHF 24.-. Im Austausch wählen Sie den gewünschten Zugknopf auf Seite 358.
Varianti: per il lavello sottopiano Daneo con pomolo standard Advant cromato, ordinate
xx.xxx.xx.01 – Articolo standard senza pomolo. Riduzione di CHF 24.-. In sostituzione, scegliete il pomolo desiderato a pagina 358.

Preis CHF/Prezzo in CHF

Modell Modello	Material Materiale	Ventil sFlow, Typ S Piletta sFlow, tipo S	Artikel-Nr. N. di articolo	Beckentiefe Profondità	Exkl. MWST IVA esclusa	Inkl. MWST IVA inclusa	VRG TRA		
Daneo DAN 45U	Edelstahl, matt Acciaio inox, opaco	18/10	3 1/2" TouchFlow	10.103.535.00	175 mm	A	1300.-	1405.-	0.19
			3 1/2" Raumspaar Salvaspazio	10.103.536.00	175 mm	A	1102.-	1191.-	
			3 1/2" Tipo	10.103.537.00	175 mm	A	1061.-	1147.-	

Daneo: DAN 45U

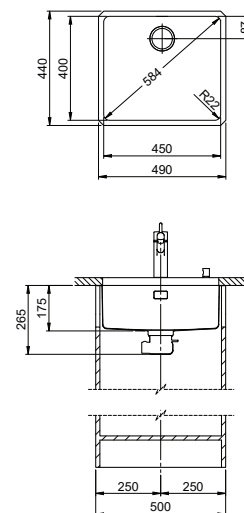
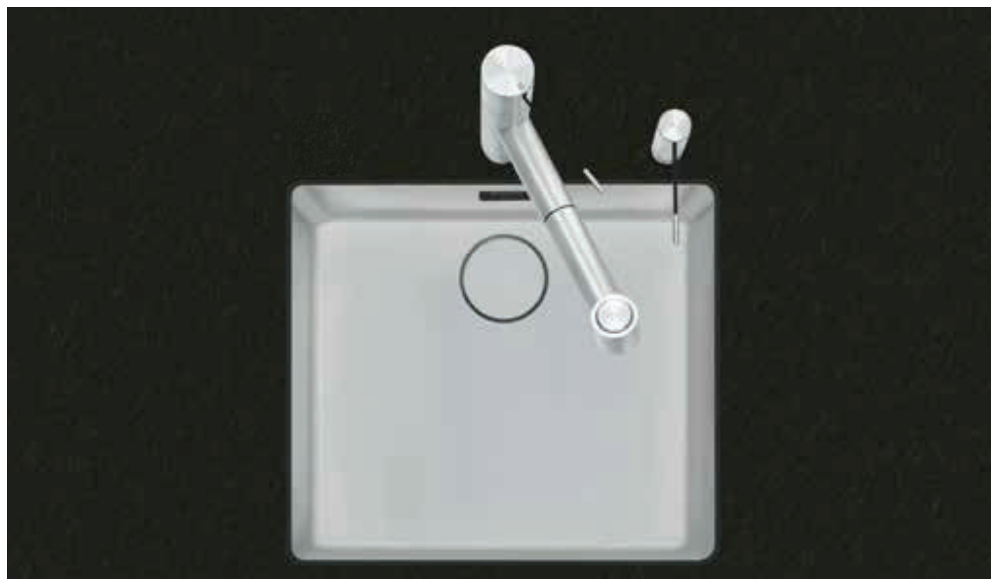

eFlow mit eControl
eFlow con eControl

27

Schwenkbare Überlaufkappe
Placchetta di troppopieno a ribalta

27

Desino: Verdeckter Ablauf mit untenliegendem Sieb
Desino: Scarico coperto con griglietta inferiore

26



Für eFlow
Per eFlow



Für TouchFlow Desino und Raumspar Desino
Per TouchFlow Desino e Salvaspazio Desino



Für eFlow Desino, TouchFlow Desino und Raumspar Desino
Per eFlow Desino, TouchFlow Desino e Salvaspazio Desino

Optionales Zubehör / Accessori opzionali

310



Resteschale gelocht
Vaschetta forato
CHF 106.– 40.000.912.00



Resteschale ungelocht
Vaschetta non forato
CHF 106.– 40.001.289.00

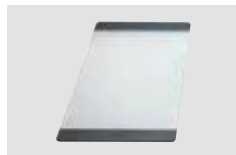

Schneidebrett aus Glas
Tagliere in vetro
CHF 151.– 40.000.909.00



Schneidebrett aus Kunststoff
Tagliere sintetico
CHF 151.– 40.001.277.00

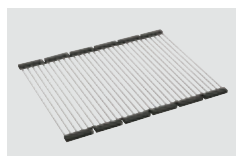

Inox Pad
CHF 125.– 40.001.138.00

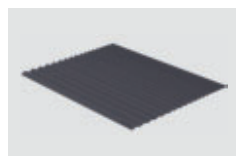

Maro Abtropfmatte aus Silikon
Maro tappetino scolapiatti in silicone
CHF 51.– 40.002.008.00

Zeichnung als pdf / dxf und Montageanleitung siehe:
V. disegno in formato pdf / dxf e montaggio:
suter.ch

Varianten: Für das Unterbau-Becken Daneo mit Standard Zugknopf Advant Chrom bestellen Sie
xx.xxx.xx.01 Standardartikel ohne Zugknopf. Reduktion CHF 24.–. Im Austausch wählen Sie den gewünschten Zugknopf auf Seite 358.
Varianti: per il lavello sottopiano Daneo con pomolo standard Advant cromato, ordinate
xx.xxx.xx.01 – Articolo standard senza pomolo. Riduzione di CHF 24.–. In sostituzione, scegliete il pomolo desiderato a pagina 358.

Preis CHF/Prezzo in CHF

Modell Modello	Material Materiale	Ventil sFlow, Typ M Piletta sFlow, tipo M	Artikel-Nr. N. di articolo	Beckentiefe Profondità	Exkl. MWST IVA esclusa	Inkl. MWST IVA inclusa	VRG TRA
Daneo DAN 45U	Edelstahl, matt Acciaio inox, opaco	18/10	3 1/2" eFlow Desino	10.104.666.00	175 mm	A 1567.–	1694.– 0.19
			3 1/2" TouchFlow Desino	10.104.636.00	175 mm	A 1452.–	1570.– 0.19
			3 1/2" Raumspar Desino Salvaspazio Desino	10.104.637.00	175 mm	A 1242.–	1343.–

Daneo: DAN 50U

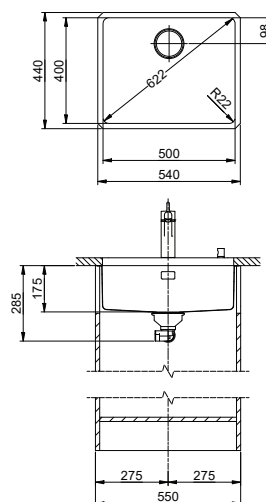

Schwenkbare Überlaufkappe
Placchetta di troppopieno a ribalta

27

Obenliegendes Sieb
Griglietta superiore

26



Zeichnung als pdf/dxf und Montageanleitung siehe:
V. disegno in formato pdf/dxf e montaggio:
suter.ch

Optionales Zubehör / Accessori opzionali

310

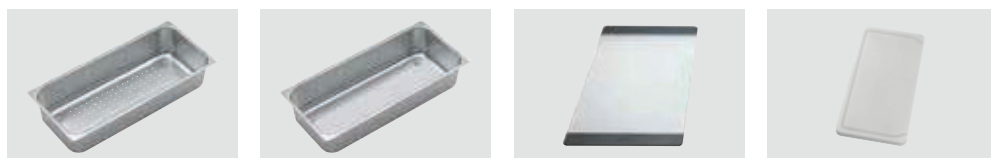

Resteschale gelocht
Vaschetta forato

CHF 106.- 40.000.912.00

Resteschale ungelocht
Vaschetta non forato

CHF 106.- 40.001.289.00

Schneidebrett aus Glas
Tagliere in vetro

CHF 151.- 40.000.909.00

Schneidebrett aus Kunststoff
Tagliere sintetico

CHF 151.- 40.001.277.00

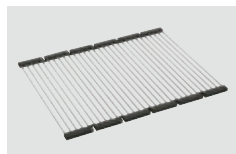

Innox Pad

CHF 125.- 40.001.138.00

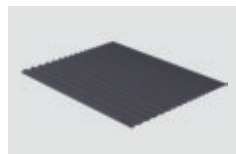

Maro Abtropfmatte aus Silikon
Maro tappetino scolapiatti in silicone

CHF 51.- 40.002.008.00

Varianten: Für das Unterbau-Becken Daneo mit Standard Zugknopf Advant Chrom bestellen Sie
xx.xxx.xx.01 Standardartikel ohne Zugknopf. Reduktion CHF 24.-. Im Austausch wählen Sie den gewünschten Zugknopf auf Seite 358.
Varianti: per il lavello sottopiano Daneo con pomolo standard Advant cromato, ordinate
xx.xxx.xx.01 – Articolo standard senza pomolo. Riduzione di CHF 24.-. In sostituzione, scegliete il pomolo desiderato a pagina 358.

Preis CHF/Prezzo in CHF

Modell Modello	Material Materiale	Ventil sFlow, Typ S Piletta sFlow, tipo S	Artikel-Nr. N. di articolo	Beckentiefe Profondità	Exkl. MWST IVA esclusa	Inkl. MWST IVA inclusa	VRG TRA		
Daneo DAN 50U	Edelstahl, matt Acciaio inox, opaco	18/10	3 1/2" TouchFlow	10.103.541.00	175 mm	A	1322.-	1429.-	0.19
			3 1/2" Raumspaar Salvaspazio	10.103.542.00	175 mm	A	1124.-	1215.-	
			3 1/2" Tipo	10.103.543.00	175 mm	A	1083.-	1171.-	

Daneo: DAN 50U

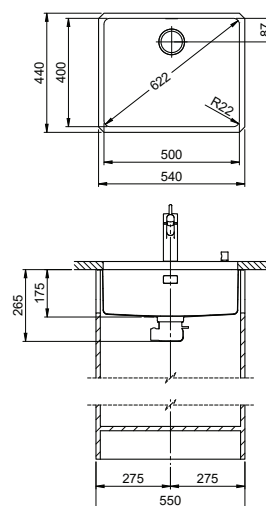

eFlow mit eControl
eFlow con eControl



Für eFlow Desino
Per eFlow Desino

27

Schwenkbare Überlaufkappe
Placchetta di troppopieno a ribalta



Für TouchFlow Desino und Raumspar Desino
Per TouchFlow Desino e Salvaspazio Desino

27

Desino: Verdeckter Ablauf mit untenliegendem Sieb
Desino: Scarico coperto con griglietta inferiore



Für eFlow Desino, TouchFlow Desino und Raumspar Desino
Per eFlow Desino, TouchFlow Desino e Salvaspazio Desino

26

Optionales Zubehör / Accessori opzionali

310



Resteschale gelocht
Vaschetta forato
CHF 106.– 40.000.912.00



Resteschale ungelocht
Vaschetta non forato
CHF 106.– 40.001.289.00

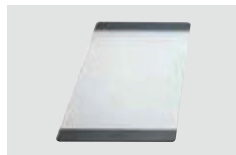

Schneidebrett aus Glas
Tagliere in vetro
CHF 151.– 40.000.909.00



Schneidebrett aus Kunststoff
Tagliere sintetico
CHF 151.– 40.001.277.00

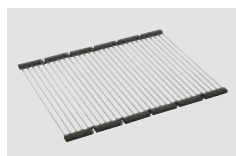

Inox Pad
CHF 125.– 40.001.138.00

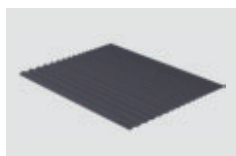

Maro Abtropfmatte aus Silikon
Maro tappetino scolapiatti in silicone
CHF 51.– 40.002.008.00

Zeichnung als pdf / dxf und Montageanleitung siehe:
V. disegno in formato pdf / dxf e montaggio:
suter.ch

! **Varianten: Für das Unterbau-Becken Daneo mit Standard Zugknopf Advant Chrom bestellen Sie**
xx.xxx.xx.01 Standardartikel ohne Zugknopf. Reduktion CHF 24.–. Im Austausch wählen Sie den gewünschten Zugknopf auf Seite 358.
Varianti: per il lavello sottopiano Daneo con pomolo standard Advant cromato, ordinate
xx.xxx.xx.01 – Articolo standard senza pomolo. Riduzione di CHF 24.–. In sostituzione, scegliete il pomolo desiderato a pagina 358.

Preis CHF/Prezzo in CHF

Modell Modello	Material Materiale	Ventil sFlow, Typ M Piletta sFlow, tipo M	Artikel-Nr. N. di articolo	Beckentiefe Profondità	Exkl. MWST IVA esclusa	Inkl. MWST IVA inclusa	VRG TRA
Daneo DAN 50U	Edelstahl, matt Acciaio inox, opaco	18/10	3 1/2" eFlow Desino	10.104.667.00	175 mm	A 1589.–	1718.– 0.19
			3 1/2" TouchFlow Desino	10.104.638.00	175 mm	A 1474.–	1593.– 0.19
			3 1/2" Raumspar Desino Salvaspazio Desino	10.104.639.00	175 mm	A 1264.–	1366.–

Daneo: DAN 55U

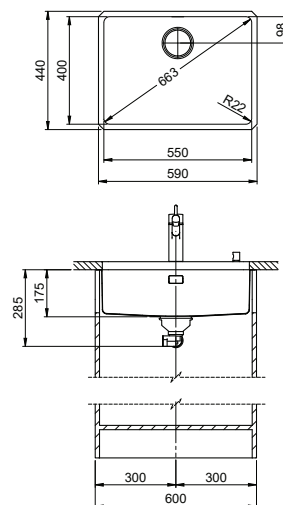

Schwenkbare Überlaufkappe
Placchetta di troppopieno a ribalta

27

Obenliegendes Sieb
Griglietta superiore

26



Zeichnung als pdf/dxf und Montageanleitung siehe:
V. disegno in formato pdf/dxf e montaggio:
suter.ch

Optionales Zubehör / Accessori opzionali

310

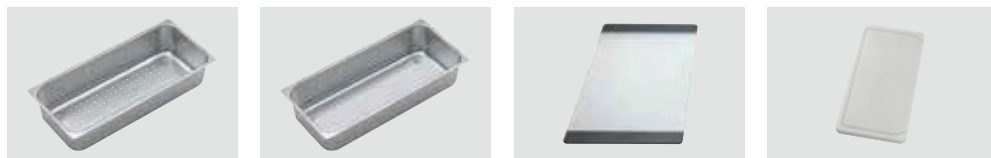

Resteschale gelocht
Vaschetta forato

CHF 106.– 40.000.912.00

Resteschale ungelocht
Vaschetta non forato

CHF 106.– 40.001.289.00

Schneidebrett aus Glas
Tagliere in vetro

CHF 151.– 40.000.909.00

Schneidebrett aus Kunststoff
Tagliere sintetico

CHF 151.– 40.001.277.00

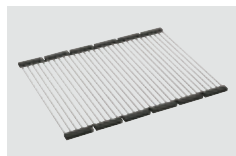

Inox Pad

CHF 125.– 40.001.138.00

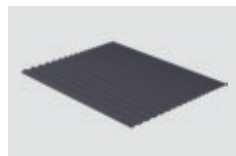

Maro Abtropfmatte aus Silikon
Maro tappetino scolapiatti in silicone

CHF 51.– 40.002.008.00

Varianten: Für das Unterbau-Becken Daneo mit Standard Zugknopf Advant Chrom bestellen Sie
xx.xxx.xx.01 Standardartikel ohne Zugknopf. Reduktion CHF 24.–. Im Austausch wählen Sie den gewünschten Zugknopf auf Seite 358.
Varianti: per il lavello sottopiano Daneo con pomolo standard Advant cromato, ordinate
xx.xxx.xx.01 – Articolo standard senza pomolo. Riduzione di CHF 24.–. In sostituzione, scegliete il pomolo desiderato a pagina 358.

Preis CHF/Prezzo in CHF

Modell Modello	Material Materiale	Ventil sFlow, Typ S Piletta sFlow, tipo S	Artikel-Nr. N. di articolo	Beckentiefe Profondità	Exkl. MWST IVA esclusa	Inkl. MWST IVA inclusa	VRG TRA		
Daneo DAN 55U	Edelstahl, matt Acciaio inox, opaco	18/10	3 1/2" TouchFlow	10.103.547.00	175 mm	A	1401.–	1514.–	0.19
			3 1/2" Raumspaar Salvaspazio	10.103.548.00	175 mm	A	1203.–	1300.–	
			3 1/2" Tipo	10.103.549.00	175 mm	A	1162.–	1256.–	

Daneo: DAN 55U

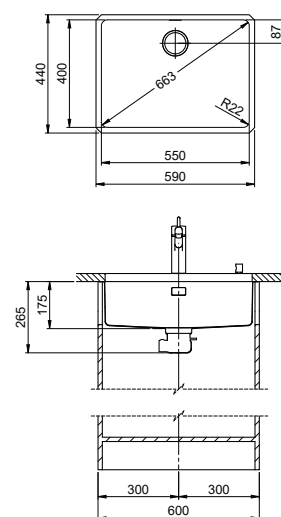

eFlow mit eControl
eFlow con eControl

27

Schwenkbare Überlaufkappe
Placchetta di troppopieno a ribalta

27

Desino: Verdeckter Ablauf mit untenliegendem Sieb
Desino: Scarico coperto con griglietta inferiore

26



Für eFlow Desino
Per eFlow Desino



Für TouchFlow Desino und Raumspar Desino
Per TouchFlow Desino e Salvaspazio Desino



Für eFlow Desino, TouchFlow Desino und Raumspar Desino
Per eFlow Desino, TouchFlow Desino e Salvaspazio Desino

Optionales Zubehör / Accessori opzionali

310



Resteschale gelocht
Vaschetta forato
CHF 106.– 40.000.912.00



Resteschale ungelocht
Vaschetta non forato
CHF 106.– 40.001.289.00

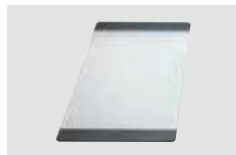

Schneidebrett aus Glas
Tagliere in vetro
CHF 151.– 40.000.909.00



Schneidebrett aus Kunststoff
Tagliere sintetico
CHF 151.– 40.001.277.00

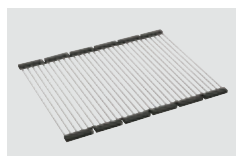

Inox Pad
CHF 125.– 40.001.138.00

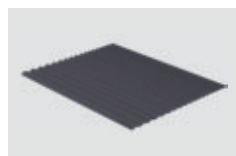

Maro Abtropfmatte aus Silikon
Maro tappetino scolapiatti in silicone
CHF 51.– 40.002.008.00

Zeichnung als pdf/dxf und Montageanleitung siehe:
V. disegno in formato pdf/dxf e montaggio:
suter.ch

Varianten: Für das Unterbau-Becken Daneo mit Standard Zugknopf Advant Chrom bestellen Sie
xx.xxx.xx.01 Standardartikel ohne Zugknopf. Reduktion CHF 24.–. Im Austausch wählen Sie den gewünschten Zugknopf auf Seite 358.
Varianti: per il lavello sottopiano Daneo con pomolo standard Advant cromato, ordinate
xx.xxx.xx.01 – Articolo standard senza pomolo. Riduzione di CHF 24.–. In sostituzione, scegliete il pomolo desiderato a pagina 358.

Preis CHF/Prezzo in CHF

Modell Modello	Material Materiale	Ventil sFlow, Typ M Piletta sFlow, tipo M	Artikel-Nr. N. di articolo	Beckentiefe Profondità	Exkl. MWST IVA esclusa	Inkl. MWST IVA inclusa	VRG TRA
Daneo DAN 55U	Edelstahl, matt Acciaio inox, opaco	18/10	3 1/2" eFlow Desino	10.104.668.00	175 mm	A 1668.–	1803.– 0.19
			3 1/2" TouchFlow Desino	10.104.640.00	175 mm	A 1553.–	1679.– 0.19
			3 1/2" Raumspar Desino Salvaspazio Desino	10.104.641.00	175 mm	A 1343.–	1452.–

Vantis: V 34U

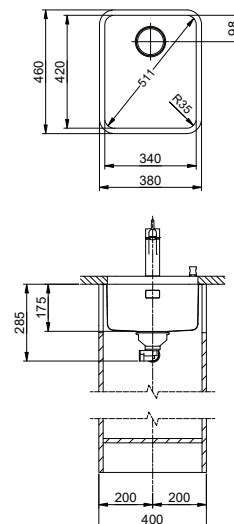

Schwenkbare Überlaufkappe
Placchetta di troppopieno a ribalta

27

Obenliegendes Sieb
Griglietta superiore

26



Zeichnung als pdf/dxf und Montageanleitung siehe:
V. disegno in formato pdf/dxf e montaggio:
suter.ch

Optionales Zubehör / Accessori opzionali

310



Resteschale gelocht
Vaschetta forato
CHF 106.– 40.000.914.00

Resteschale ungelocht
Vaschetta non forato
CHF 106.– 40.001.290.00

Schneidebrett aus Glas
Tagliere in vetro
CHF 151.– 40.000.915.00

Holz-Schneidebrett aus Nussbaum
Tagliere in legno di noce
CHF 151.– 40.001.147.00

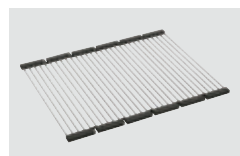

Inox Pad
CHF 125.– 40.001.138.00

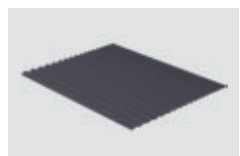

Maro Abtropfmatte aus Silikon
Maro tappetino scolapiatti in silicone
CHF 51.– 40.002.008.00

Varianten: Für das Unterbau-Becken Vantis mit Standard Zugknopf Prime Chrom bestellen Sie
xx.xxx.xx.01 Standardartikel ohne Zugknopf. Reduktion CHF 24.–. Im Austausch wählen Sie den gewünschten Zugknopf auf Seite 358.
Varianti: per il lavello sottopiano Vantis con pomolo standard Prime cromato, ordinate
xx.xxx.xx.01 – Articolo standard senza pomolo. Riduzione di CHF 24.–. In sostituzione, scegliete il pomolo desiderato a pagina 358.

Preis CHF/Prezzo in CHF

Modell Modello	Material Materiale	Ventil sFlow, Typ S Piletta sFlow, Typ S	Artikel-Nr. N. di articolo	Beckentiefe Profondità	Exkl. MWST IVA esclusa	Inkl. MWST IVA inclusa	VRG TRA
Vantis V 34U	Edelstahl, matt Acciaio inox, opaco	18/10 3 1/2" TouchFlow	10.103.877.00	175 mm	A 906.–	979.–	0.19
		3 1/2" Raumspaar Salvaspazio	10.103.878.00	175 mm	A 708.–	765.–	
		3 1/2" Tipo	10.103.879.00	175 mm	A 667.–	721.–	

Vantis: V 34U

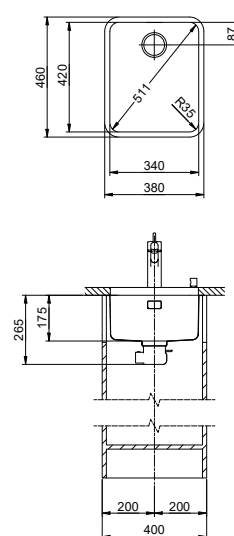

eFlow mit eControl
eFlow con eControl

27

Schwenkbare Überlaufkappe
Placchetta di troppopieno a ribalta

27

Desino: Verdeckter Ablauf mit untenliegendem Sieb
Desino: Scarico coperto con griglietta inferiore

26



Für eFlow Desino
Per eFlow Desino



Für TouchFlow Desino und Raumspar Desino
Per TouchFlow Desino e Salvaspazio Desino



Für eFlow Desino, TouchFlow Desino und Raumspar Desino
Per eFlow Desino, TouchFlow Desino e Salvaspazio Desino

Optionales Zubehör / Accessori opzionali

310



Resteschale gelocht
Vaschetta forato
CHF 106.– 40.000.914.00



Resteschale ungelocht
Vaschetta non forato
CHF 106.– 40.001.290.00

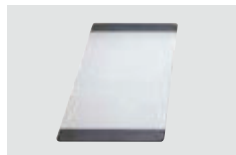

Schneidebrett aus Glas
Tagliere in vetro
CHF 151.– 40.000.915.00



Holz-Schneidebrett aus Nussbaum
Tagliere in legno di noce
CHF 151.– 40.001.147.00

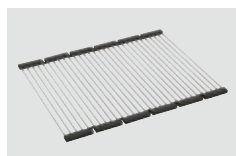

Inox Pad
CHF 125.– 40.001.138.00

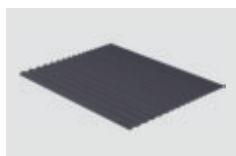

Maro Abtropfmatte aus Silikon
Maro tappetino scolapiatti in silicone
CHF 51.– 40.002.008.00

Zeichnung als pdf / dxf und Montageanleitung siehe:
V. disegno in formato pdf / dxf e montaggio:
suter.ch

Preis CHF/Prezzo in CHF

Modell Modello	Material Materiale	Ventil sFlow, Typ M Piletta sFlow, tipo M	Artikel-Nr. N. di articolo	Beckentiefe Profondità	Exkl. MWST IVA esclusa	Inkl. MWST IVA inclusa	VRG TRA
Vantis V 34U	Edelstahl, matt Acciaio inox, opaco	18/10	3 1/2" eFlow Desino	10.105.254.00	175 mm	A 1173.–	1268.– 0.19
		3 1/2" TouchFlow Desino	10.105.255.00	175 mm	A 1058.–	1144.– 0.19	
		3 1/2" Raumspar Desino Salvaspazio Desino	10.105.256.00	175 mm	A 848.–	917.–	

Vantis: V 40U

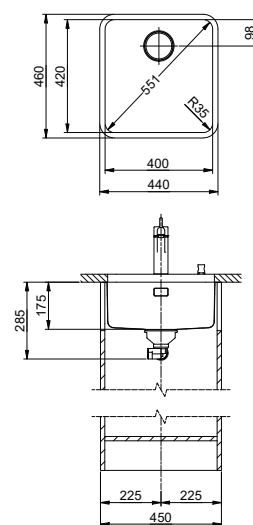

Schwenkbare Überlaufkappe
Placchetta di troppopieno a ribalta

27

Obenliegendes Sieb
Griglietta superiore

26



Zeichnung als pdf/dxf und Montageanleitung siehe:
V. disegno in formato pdf/dxf e montaggio:
suter.ch

Optionales Zubehör / Accessori opzionali

310



Resteschale gelocht
Vaschetta forata
CHF 106.– 40.000.914.00

Resteschale ungelocht
Vaschetta non forata
CHF 106.– 40.001.290.00

Schneidebrett aus Glas
Tagliere in vetro
CHF 151.– 40.000.915.00

Holz-Schneidebrett aus Nussbaum
Tagliere in legno di noce
CHF 151.– 40.001.147.00

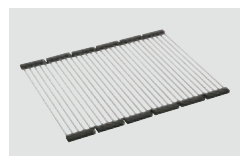

Inox Pad
CHF 125.– 40.001.138.00

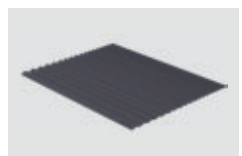

Maro Abtropfmatte aus Silikon
Maro tappetino scolapiatti in silicone
CHF 51.– 40.002.008.00

Varianten: Für das Unterbau-Becken Vantis mit Standard Zugknopf Prime Chrom bestellen Sie
xx.xxx.xx.01 Standardartikel ohne Zugknopf. Reduktion CHF 24.–. Im Austausch wählen Sie den gewünschten Zugknopf auf Seite 358.
Varianti: per il lavello sottopiano Vantis con pomolo standard Prime cromato, ordinate
xx.xxx.xx.01 – Articolo standard senza pomolo. Riduzione di CHF 24.–. In sostituzione, scegliete il pomolo desiderato a pagina 358.

Preis CHF/Prezzo in CHF

Modell Modello	Material Materiale	Ventil sFlow, Typ S Piletta sFlow, Typ S	Artikel-Nr. N. di articolo	Beckentiefe Profondità	Exkl. MWST IVA esclusa	Inkl. MWST IVA inclusa	VRG TRA		
Vantis V 40U	Edelstahl, matt Acciaio inox, opaco	18/10	3 1/2" TouchFlow	10.103.883.00	175 mm	A	917.–	991.–	0.19
			3 1/2" Raumspär Salvaspazio	10.103.884.00	175 mm	A	719.–	777.–	
			3 1/2" Tipo	10.103.885.00	175 mm	A	678.–	733.–	

Vantis: V 40U

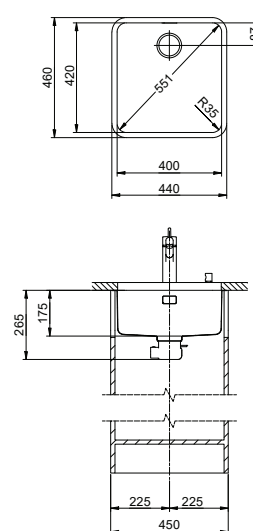

eFlow mit eControl
eFlow con eControl



Schwenkbare Überlaufkappe
Placchetta di troppopieno a ribalta



Desino: Verdeckter Ablauf mit untenliegendem Sieb
Desino: Scarico coperto con griglietta inferiore



Für eFlow Desino
Per eFlow Desino



Für TouchFlow Desino und Raumspars Desino
Per TouchFlow Desino e Salvaspazio Desino



Für eFlow Desino, TouchFlow Desino und Raumspars Desino
Per eFlow Desino, TouchFlow Desino e Salvaspazio Desino

Optionales Zubehör / Accessori opzionali



Resteschale gelocht
Vaschetta forato
CHF 106.– 40.000.914.00



Resteschale ungelocht
Vaschetta non forato
CHF 106.– 40.001.290.00

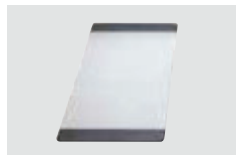

Schneidebrett aus Glas
Tagliere in vetro
CHF 151.– 40.000.915.00



Holz-Schneidebrett aus Nussbaum
Tagliere in legno di noce
CHF 151.– 40.001.147.00

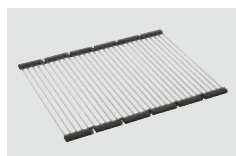

Inox Pad
CHF 125.– 40.001.138.00

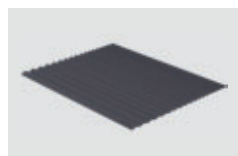

Maro Abtropfmatte aus Silikon
Maro tappetino scolapiatti in silicone
CHF 51.– 40.002.008.00

Zeichnung als pdf / dxf und Montageanleitung siehe:
V. disegno in formato pdf / dxf e montaggio:
suter.ch

Preis CHF/Prezzo in CHF

Modell Modello	Material Materiale	Ventil sFlow, Typ M Piletta sFlow, tipo M	Artikel-Nr. N. di articolo	Beckentiefe Profondità	Exkl. MWST IVA esclusa	Inkl. MWST IVA inclusa	VRG TRA
Vantis V 40U	Edelstahl, matt Acciaio inox, opaco	3 1/2" eFlow Desino	10.105.257.00	175 mm	1184.–	1280.–	0.19
		3 1/2" TouchFlow Desino	10.105.258.00	175 mm	1069.–	1156.–	0.19
		3 1/2" Raumspars Desino Salvaspazio Desino	10.105.259.00	175 mm	859.–	929.–	

Vantis: V 45U

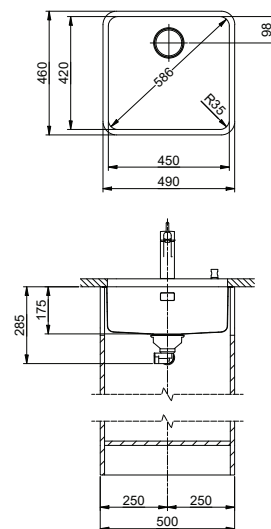

Schwenkbare Überlaufkappe
Placchetta di troppopieno a ribalta

27

Obenliegendes Sieb
Griglietta superiore

26



Zeichnung als pdf/dxf und Montageanleitung siehe:
V. disegno in formato pdf/dxf e montaggio:
suter.ch

Optionales Zubehör / Accessori opzionali

310



Resteschale gelocht
Vaschetta forato

CHF 106.– 40.000.914.00

Resteschale ungelocht
Vaschetta non forato

CHF 106.– 40.001.290.00

Schneidebrett aus Glas
Tagliere in vetro

CHF 151.– 40.000.915.00

Holz-Schneidebrett aus Nussbaum
Tagliere in legno di noce

CHF 151.– 40.001.147.00

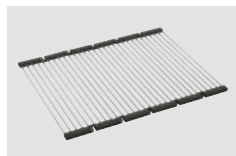

Innox Pad

CHF 125.– 40.001.138.00

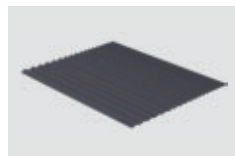

Maro Abtropfmatte aus Silikon
Maro tappetino scolapiatti in silicone

CHF 51.– 40.002.008.00

Varianten: Für das Unterbau-Becken Vantis mit Standard Zugknopf Prime Chrom bestellen Sie
xx.xxx.xx.01 Standardartikel ohne Zugknopf. Reduktion CHF 24.–. Im Austausch wählen Sie den gewünschten Zugknopf auf Seite 358.
Varianti: per il lavello sottopiano Vantis con pomolo standard Prime cromato, ordinate
xx.xxx.xx.01 – Articolo standard senza pomolo. Riduzione di CHF 24.–. In sostituzione, scegliete il pomolo desiderato a pagina 358.

Preis CHF/Prezzo in CHF

Modell Modello	Material Materiale	Ventil sFlow, Typ S Piletta sFlow, Typ S	Artikel-Nr. N. di articolo	Beckentiefe Profondità	Exkl. MWST IVA esclusa	Inkl. MWST IVA inclusa	VRG TRA
Vantis V 45U	Edelstahl, matt Acciaio inox, opaco	18/10 3 1/2" TouchFlow	10.103.889.00	175 mm	A 927.–	1002.–	0.19
		3 1/2" Raumspaar Salvaspazio	10.103.890.00	175 mm	A 729.–	788.–	
		3 1/2" Tipo	10.103.891.00	175 mm	A 680.–	735.–	

Vantis: V 45U

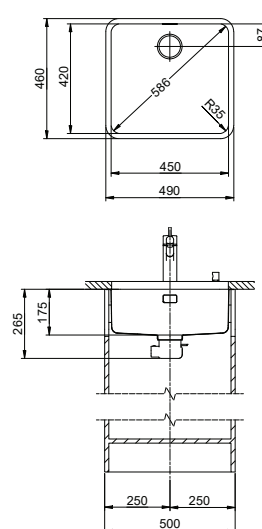

eFlow mit eControl
eFlow con eControl

27

Schwenkbare Überlaufkappe
Placchetta di troppopieno a ribalta

27

Desino: Verdeckter Ablauf mit untenliegendem Sieb
Desino: Scarico coperto con griglietta inferiore

26



Für eFlow Desino
Per eFlow Desino



Für TouchFlow Desino und Raumspaar Desino
Per TouchFlow Desino e Salvaspazio Desino



Für eFlow Desino, TouchFlow Desino und Raumspaar Desino
Per eFlow Desino, TouchFlow Desino e Salvaspazio Desino

Optionales Zubehör / Accessori opzionali

310



Resteschale gelocht
Vaschetta forato
CHF 106.– 40.000.914.00



Resteschale ungelocht
Vaschetta non forato
CHF 106.– 40.001.290.00

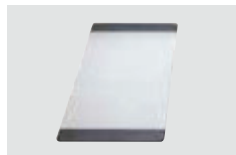

Schneidebrett aus Glas
Tagliere in vetro
CHF 151.– 40.000.915.00



Holz-Schneidebrett aus Nussbaum
Tagliere in legno di noce
CHF 151.– 40.001.147.00

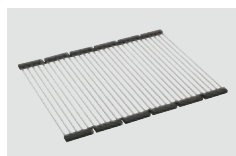

Inox Pad
CHF 125.– 40.001.138.00

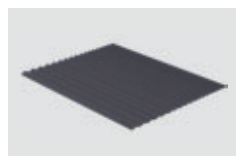

Maro Abtropfmatte aus Silikon
Maro tappetino scolapiatti in silicone
CHF 51.– 40.002.008.00

Zeichnung als pdf / dxf und Montageanleitung siehe:
V. disegno in formato pdf / dxf e montaggio:
suter.ch

Varianten: Für das Unterbau-Becken Vantis mit Standard Zugknopf Advant Chrom bestellen Sie
xx.xxx.xx.01 Standardartikel ohne Zugknopf. Reduktion CHF 24.–. Im Austausch wählen Sie den gewünschten Zugknopf auf Seite 358.
Varianti: per il lavello sottopiano Vantis con pomolo standard Advant cromato, ordinate
xx.xxx.xx.01 – Articolo standard senza pomolo. Riduzione di CHF 24.–. In sostituzione, scegliete il pomolo desiderato a pagina 358.

Preis CHF/Prezzo in CHF

Modell Modello	Material Materiale	Ventil sFlow, Typ M Piletta sFlow, tipo M	Artikel-Nr. N. di articolo	Beckentiefe Profondità	Exkl. MWST IVA esclusa	Inkl. MWST IVA inclusa	VRG TRA	
Vantis V 45U	Edelstahl, matt Acciaio inox, opaco	18/10	3 1/2" eFlow Desino	10.105.267.00	175 mm	A 1194.–	1291.–	0.19
			3 1/2" TouchFlow Desino	10.105.204.00	175 mm	A 1079.–	1166.–	0.19
			3 1/2" Raumspaar Desino Salvaspazio Desino	10.105.205.00	175 mm	A 869.–	939.–	

Vantis: V 50-42U

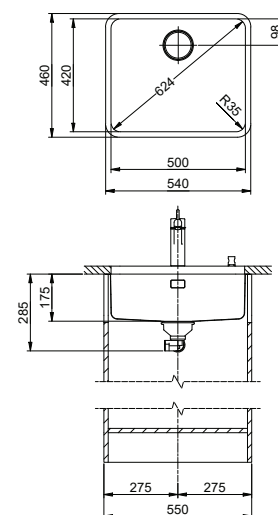

Schwenkbare Überlaufkappe
Placchetta di troppopieno a ribalta

27

Obenliegendes Sieb
Griglietta superiore

26



Zeichnung als pdf/dxf und Montageanleitung siehe:
V. disegno in formato pdf/dxf e montaggio:
suter.ch

Optionales Zubehör / Accessori opzionali

310



Resteschale gelocht
Vaschetta forato
CHF 106.– 40.000.914.00

Resteschale ungelocht
Vaschetta non forato
CHF 106.– 40.001.290.00

Schneidebrett aus Glas
Tagliere in vetro
CHF 151.– 40.000.915.00

Holz-Schneidebrett aus Nussbaum
Tagliere in legno di noce
CHF 151.– 40.001.147.00

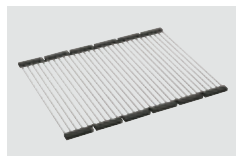

Inox Pad
CHF 125.– 40.001.138.00

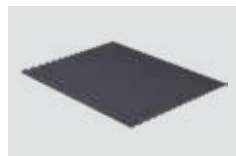

Maro Abtropfmatte aus Silikon
Maro tappetino scolapiatti in silicone
CHF 51.– 40.002.008.00

Varianten: Für das Unterbau-Becken Vantis mit Standard Zugknopf Prime Chrom bestellen Sie
xx.xxx.xx.01 Standardartikel ohne Zugknopf. Reduktion CHF 24.–. Im Austausch wählen Sie den gewünschten Zugknopf auf Seite 358.
Varianti: per il lavello sottopiano Vantis con pomolo standard Prime cromato, ordinate
xx.xxx.xx.01 – Articolo standard senza pomolo. Riduzione di CHF 24.–. In sostituzione, scegliete il pomolo desiderato a pagina 358.

Preis CHF/Prezzo in CHF

Modell Modello	Material Materiale	Ventil sFlow, Typ S Piletta sFlow, Typ S	Artikel-Nr. N. di articolo	Beckentiefe Profondità	Exkl. MWST IVA esclusa	Inkl. MWST IVA inclusa	VRG TRA
Vantis V 50-42U	Edelstahl, matt Acciaio inox, opaco 18/10	3 1/2" TouchFlow	10.103.895.00	175 mm	A 1110.–	1200.–	0.19
		3 1/2" Raumspär Salvaspazio	10.103.896.00	175 mm	A 912.–	986.–	
		3 1/2" Tipo	10.103.897.00	175 mm	A 863.–	933.–	

Vantis: V 50-42U

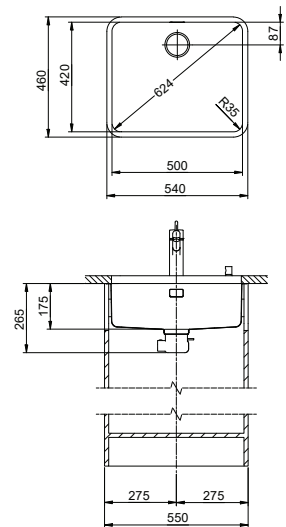

eFlow mit eControl
eFlow con eControl

27

Schwenkbare Überlaufkappe
Placchetta di troppopieno a ribalta

27

Desino: Verdeckter Ablauf mit untenliegendem Sieb
Desino: Scarico coperto con griglietta inferiore

26



Für eFlow Desino
Per eFlow Desino



Für TouchFlow Desino und Raumspars Desino
Per TouchFlow Desino e Salvaspazio Desino



Für eFlow Desino, TouchFlow Desino und Raumspars Desino
Per eFlow Desino, TouchFlow Desino e Salvaspazio Desino

Optionales Zubehör / Accessori opzionali

310



Resteschale gelocht
Vaschetta forato
CHF 106.– 40.000.914.00



Resteschale ungelocht
Vaschetta non forato
CHF 106.– 40.001.290.00

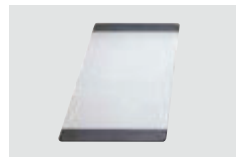

Schneidebrett aus Glas
Tagliere in vetro
CHF 151.– 40.000.915.00



Holz-Schneidebrett aus Nussbaum
Tagliere in legno di noce
CHF 151.– 40.001.147.00

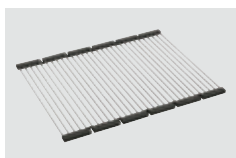

Inox Pad
CHF 125.– 40.001.138.00

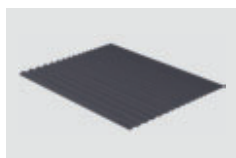

Maro Abtropfmatte aus Silikon
Maro tappetino scolapiatti in silicone
CHF 51.– 40.002.008.00

Zeichnung als pdf / dxf und Montageanleitung siehe:
V. disegno in formato pdf / dxf e montaggio:
suter.ch

Varianten: Für das Unterbau-Becken Vantis mit Standard Zugknopf Advant Chrom bestellen Sie
xx.xxx.xx.01 Standardartikel ohne Zugknopf. Reduktion CHF 24.–. Im Austausch wählen Sie den gewünschten Zugknopf auf Seite 358.
Varianti: per il lavello sottopiano Vantis con pomolo standard Advant cromato, ordinate
xx.xxx.xx.01 – Articolo standard senza pomolo. Riduzione di CHF 24.–. In sostituzione, scegliete il pomolo desiderato a pagina 358.

Preis CHF/Prezzo in CHF

Modell Modello	Material Materiale	Ventil sFlow, Typ M Piletta sFlow, tipo M	Artikel-Nr. N. di articolo	Beckentiefe Profondità	Exkl. MWST IVA esclusa	Inkl. MWST IVA inclusa	VRG TRA
Vantis V 50-42U	Edelstahl, matt Acciaio inox, opaco	18/10	3 1/2" eFlow Desino	10.105.268.00	175 mm	A 1377.–	1489.– 0.19
			3 1/2" TouchFlow Desino	10.105.206.00	175 mm	A 1262.–	1364.– 0.19
			3 1/2" Raumspars Desino Salvaspazio Desino	10.105.207.00	175 mm	A 1052.–	1137.–

Vantis: V 50-35U + V 11U

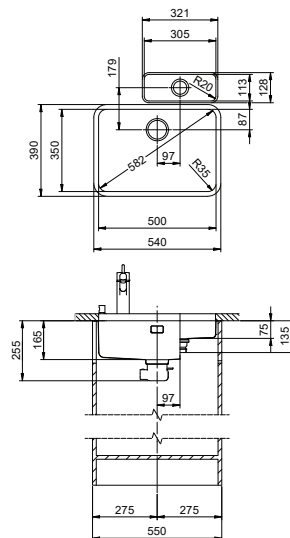

eFlow mit eControl
eFlow con eControl

Schwenkbare Überlaufkappe
Placchetta di troppopieno a ribalta

Desino: Verdeckter Ablauf mit untenliegendem Sieb
Desino: Scarico coperto con griglietta inferiore



Für eFlow Desino
Per eFlow Desino



Für TouchFlow Desino und Raumspaar Desino
Per TouchFlow Desino e Salvaspazio Desino



Für eFlow Desino, TouchFlow Desino und Raumspaar Desino
Per eFlow Desino, TouchFlow Desino e Salvaspazio Desino

Optionales Zubehör / Accessori opzionali

310



Resteschale zu V 11U
Vaschetta per V 11U
CHF 106.– 40.001.060.00



Resteschale gelocht
Vaschetta forata
CHF 106.– 40.000.916.00

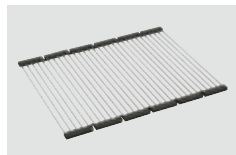

Inox Pad
CHF 125.– 40.001.139.00

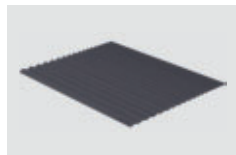

Maro Abtropfmatte aus Silikon
Maro tappetino scolapiatti in silicone
CHF 51.– 40.002.008.00

Zeichnung als pdf / dxf und Montageanleitung siehe:
V. disegno in formato pdf / dxf e montaggio:
suter.ch

Preis CHF / Prezzo in CHF

Modell Modello	Material Materiale	Ventil sFlow, Typ M Piletta sFlow, tipo M	Artikel-Nr. N. di articolo	Beckentiefe Profondità	Exkl. MWST IVA esclusa	Inkl. MWST IVA inclusa	VRG TRA
Vantis V 50-35U	Edelstahl, matt Acciaio inox, opaco	18/10	3 1/2" eFlow Desino	10.105.260.00	165 mm	A 1174.–	1269.– 0.19
			3 1/2" TouchFlow Desino	10.105.261.00	165 mm	A 1059.–	1145.– 0.19
			3 1/2" Raumspaar Desino Salvaspazio	10.105.262.00	165 mm	A 849.–	918.–
Vantis V 11U	Edelstahl, matt Acciaio inox, opaco	18/10	1 1/2" Stopfen A tappo	10.103.873.00	75 mm	A 553.–	598.–
Vantis V 50-35U + Vantis V 11U	Edelstahl, matt Acciaio inox, opaco	18/10	3 1/2" eFlow Desino + 1 1/2" Stopfen A tappo	10.105.263.00	165 mm 75 mm	A 1685.–	1821.– 0.19
			3 1/2" TouchFlow Desino + 1 1/2" Stopfen A tappo	10.105.264.00	165 mm 75 mm	A 1570.–	1697.– 0.19
			3 1/2" Raumspaar Desino + 1 1/2" Stopfen A tappo	10.105.265.00	165 mm 75 mm	A 1360.–	1470.–

Vantis: V 55U

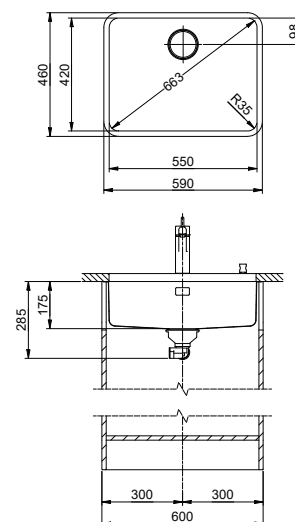

Schwenkbare Überlaufkappe
Placchetta di troppopieno a ribalta

27

Obenliegendes Sieb
Griglietta superiore

26



Zeichnung als pdf/dxf und Montageanleitung siehe:
V. disegno in formato pdf/dxf e montaggio:
suter.ch

Optionales Zubehör / Accessori opzionali

310



Resteschale gelocht
Vaschetta forato
CHF 106.– 40.000.914.00

Resteschale ungelocht
Vaschetta non forato
CHF 106.– 40.001.290.00

Schneidebrett aus Glas
Tagliere in vetro
CHF 151.– 40.000.915.00

Holz-Schneidebrett aus Nussbaum
Tagliere in legno di noce
CHF 151.– 40.001.147.00

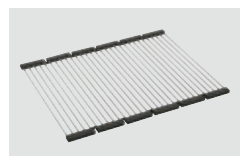

Inox Pad
CHF 125.– 40.001.138.00

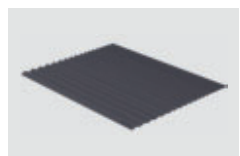

Maro Abtropfmatte aus Silikon
Maro tappetino scolapiatti in silicone
CHF 51.– 40.002.008.00

Varianten: Für das Unterbau-Becken Vantis mit Standard Zugknopf Prime Chrom bestellen Sie
xx.xxx.xx.01 Standardartikel ohne Zugknopf. Reduktion CHF 24.–. Im Austausch wählen Sie den gewünschten Zugknopf auf Seite 358.
Varianti: per il lavello sottopiano Vantis con pomolo standard Prime cromato, ordinate
xx.xxx.xx.01 – Articolo standard senza pomolo. Riduzione di CHF 24.–. In sostituzione, scegliete il pomolo desiderato a pagina 358.

Preis CHF/Prezzo in CHF

Modell Modello	Material Materiale	Ventil sFlow, Typ S Piletta sFlow, Typ S	Artikel-Nr. N. di articolo	Beckentiefe Profondità	Exkl. MWST IVA esclusa	Inkl. MWST IVA inclusa	VRG TRA		
Vantis V 55U	Edelstahl, matt Acciaio inox, opaco	18/10	3 1/2" TouchFlow	10.103.901.00	175 mm	A	1320.–	1427.–	0.19
			3 1/2" Raumspär Salvaspazio	10.103.902.00	175 mm	A	1122.–	1213.–	
			3 1/2" Tipo	10.103.903.00	175 mm	A	1081.–	1169.–	

Vantis: V 55U

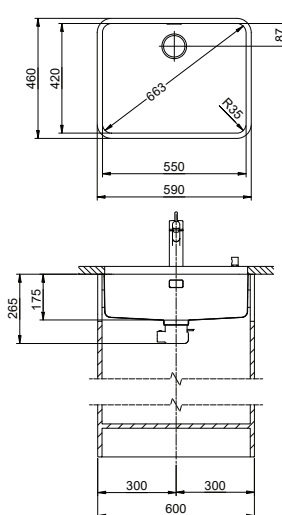

eFlow mit eControl
eFlow con eControl

27

Schwenkbare Überlaufkappe
Placchetta di troppopieno a ribalta

27

Desino: Verdeckter Ablauf mit untenliegendem Sieb
Desino: Scarico coperto con griglietta inferiore

26



Für eFlow Desino
Per eFlow Desino



Für TouchFlow Desino und Raumspaar Desino
Per TouchFlow Desino e Salvaspazio Desino



Für eFlow Desino, TouchFlow Desino und Raumspaar Desino
Per eFlow Desino, TouchFlow Desino e Salvaspazio Desino

Optionales Zubehör/Accessori opzionali

310



Resteschale gelocht
Vaschetta forato
CHF 106.– 40.000.914.00



Resteschale ungelocht
Vaschetta non forato
CHF 106.– 40.001.290.00

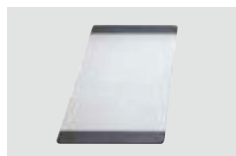

Schneidebrett aus Glas
Tagliere in vetro
CHF 151.– 40.000.915.00



Holz-Schneidebrett aus Nussbaum
Tagliere in legno di noce
CHF 151.– 40.001.147.00

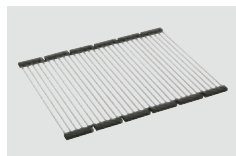

Inox Pad
CHF 125.– 40.001.138.00

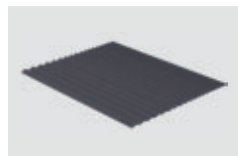

Maro Abtropfmatte aus Silikon
Maro tappetino scolapiatti in silicone
CHF 51.– 40.002.008.00

Zeichnung als pdf/dxf und Montageanleitung siehe:
V. disegno in formato pdf/dxf e montaggio:
suter.ch

Varianten: Für das Unterbau-Becken Vantis mit Standard Zugknopf Advant Chrom bestellen Sie
xx.xxx.xx.01 Standardartikel ohne Zugknopf. Reduktion CHF 24.–. Im Austausch wählen Sie den gewünschten Zugknopf auf Seite 358.
Varianti: per il lavello sottopiano Vantis con pomolo standard Advant cromato, ordinate
xx.xxx.xx.01 – Articolo standard senza pomolo. Riduzione di CHF 24.–. In sostituzione, scegliete il pomolo desiderato a pagina 358.

Preis CHF/Prezzo in CHF

Modell Modello	Material Materiale	Ventil sFlow, Typ M Piletta sFlow, tipo M	Artikel-Nr. N. di articolo	Beckentiefe Profondità	Exkl. MWST IVA esclusa	Inkl. MWST IVA inclusa	VRG TRA
Vantis V 55U	Edelstahl, matt Acciaio inox, opaco	18/10	3 1/2" eFlow Desino	10.105.269.00	175 mm	A 1587.–	1716.– 0.19
		3 1/2" TouchFlow Desino	10.105.208.00	175 mm	A 1472.–	1591.– 0.19	
		3 1/2" Raumspaar Desino Salvaspazio Desino	10.105.209.00	175 mm	A 1262.–	1364.–	

Vantis: VX 34U Varix

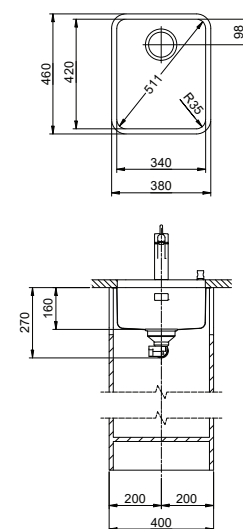



Verdeckter Überlauf
Troppopieno coperto



Zeichnung als pdf/dxf und Montageanleitung siehe:
V. disegno in formato pdf/dxf e montaggio:
suter.ch

Optionales Zubehör / Accessori opzionali



			
Resteschale gelocht Vaschetta forato	Resteschale ungelocht Vaschetta non forato	Schneidebrett aus Glas Tagliere in vetro	Holz-Schneidebrett aus Nussbaum Tagliere in legno di noce
CHF 106.- 40.000.914.00	CHF 106.- 40.001.290.00	CHF 151.- 40.000.915.00	CHF 151.- 40.001.147.00
			
Inox Pad	Maro Abtropfmatte aus Silikon Maro tappetino scolapiatti in silicone		
CHF 125.- 40.001.138.00	CHF 51.- 40.002.008.00		

Preis CHF/Prezzo in CHF

Modell Modello	Material Materiale	Ventil Piletta	Artikel-Nr. N. di articolo	Beckentiefe Profondità	Exkl. MWST IVA esclusa	Inkl. MWST IVA inclusa
Vantis VX 34U Varix	Edelstahl, mid-matt Acciaio inox, mid-matt	18/10	3 1/2" Raumspar Salvaspazio	10.105.250.00	160 mm	A 642.- 694.-
		3 1/2"	Siebstopfen A tappo con griglietta	10.105.251.00	160 mm	A 601.- 650.-

Vantis: VX 40U Varix

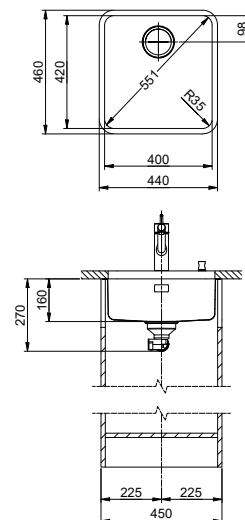

Verdeckter Überlauf
Trooppieno coperto

27



Zeichnung als pdf/dxf und Montageanleitung siehe:
V. disegno in formato pdf/dxf e montaggio:
suter.ch

Optionales Zubehör / Accessori opzionali

310

Resteschale gelocht Vaschetta forato	Resteschale ungelocht Vaschetta non forato	Schneidebrett aus Glas Tagliere in vetro	Holz-Schneidebrett aus Nussbaum Tagliere in legno di noce
CHF 106.– 40.000.914.00	CHF 106.– 40.001.290.00	CHF 151.– 40.000.915.00	CHF 151.– 40.001.147.00
Inox Pad	Maro Abtropfmatte aus Silikon Maro tappetino scolapiatti in silicone		
CHF 125.– 40.001.138.00	CHF 51.– 40.002.008.00		

Varianten: Für das Unterbau-Becken Vantis mit Standard Zugknopf Prime Chrom bestellen Sie
xx.xxx.xx.01 Standardartikel ohne Zugknopf. Reduktion CHF 24.–. Im Austausch wählen Sie den gewünschten Zugknopf auf Seite 358.
Varianti: per il lavello sottopiano Vantis con pomolo standard Prime cromato, ordinate
xx.xxx.xx.01 – Articolo standard senza pomolo. Riduzione di CHF 24.–. In sostituzione, scegliete il pomolo desiderato a pagina 358.

Preis CHF/Prezzo in CHF

Modell Modello	Material Materiale	Ventil Piletta	Artikel-Nr. N. di articolo	Beckentiefe Profondità	Exkl. MWST IVA esclusa	Inkl. MWST IVA inclusa
Vantis VX 40U Varix	Edelstahl, mid-matt Acciaio inox, mid-matt	18/10	3 1/2" Raumspar Salvaspazio	10.103.958.00	160 mm	A 662.– 716.–
		3 1/2" Siebstopfen A tappo con griglietta	10.103.959.00	160 mm	A 621.– 671.–	

Vantis: VX 45U Varix

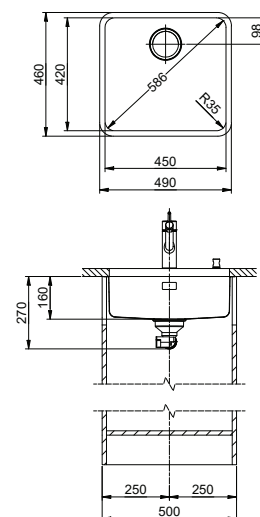

Verdeckter Überlauf
Troppopieno coperto

27



Zeichnung als pdf / dxf und Montageanleitung siehe:
V. disegno in formato pdf / dxf e montaggio:
suter.ch

Optionales Zubehör / Accessori opzionali

310

Resteschale gelocht Vaschetta forato	Resteschale ungelocht Vaschetta non forato	Schneidebrett aus Glas Tagliere in vetro	Holz-Schneidebrett aus Nussbaum Tagliere in legno di noce
CHF 106.– 40.000.914.00	CHF 106.– 40.001.290.00	CHF 151.– 40.000.915.00	CHF 151.– 40.001.147.00
Inox Pad	Maro Abtropfmatte aus Silikon Maro tappetino scolapiatti in silicone		
CHF 125.– 40.001.138.00	CHF 51.– 40.002.008.00		

Varianten: Für das Unterbau-Becken Vantis mit Standard Zugknopf Prime Chrom bestellen Sie
xx.xxx.xx.01 Standardartikel ohne Zugknopf. Reduktion CHF 24.–. Im Austausch wählen Sie den gewünschten Zugknopf auf Seite 358.
Varianti: per il lavello sottopiano Vantis con pomolo standard Prime cromato, ordinate
xx.xxx.xx.01 – Articolo standard senza pomolo. Riduzione di CHF 24.–. In sostituzione, scegliete il pomolo desiderato a pagina 358.

Preis CHF / Prezzo in CHF

Modell Modello	Material Materiale	Ventil Piletta	Artikel-Nr. N. di articolo	Beckentiefe Profondità	Exkl. MWST IVA esclusa	Inkl. MWST IVA inclusa
Vantis VX 45U Varix	Edelstahl, mid-matt Acciaio inox, mid-matt	18 / 10	3 1/2" Raumspar Salvaspazio	10.104.143.00	160 mm	A 679.– 734.–
		3 1/2" Siebstopfen A tappo con griglietta	10.104.144.00	160 mm	A 638.– 690.–	

Vantis: VX 50-42U Varix

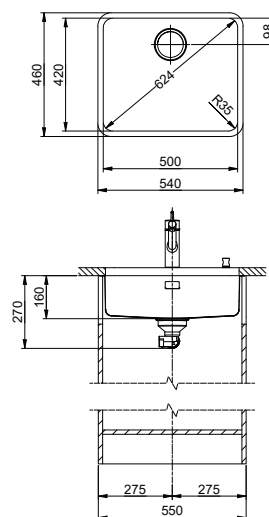

Verdeckter Überlauf
Trooppieno coperto



Zeichnung als pdf / dxf und Montageanleitung siehe:
V. disegno in formato pdf / dxf e montaggio:
suter.ch

Optionales Zubehör / Accessori opzionali



- | | | | |
|--|--|--|---|
| | | | |
| Resteschale gelocht
Vaschetta forato | Resteschale ungelocht
Vaschetta non forato | Schneidebrett aus Glas
Tagliere in vetro | Holz-Schneidebrett aus Nussbaum
Tagliere in legno di noce |
| CHF 106.– 40.000.914.00 | CHF 106.– 40.001.290.00 | CHF 151.– 40.000.915.00 | CHF 151.– 40.001.147.00 |
| | | | |
| Inox Pad | Maro Abtropfmatte aus Silikon
Maro tappetino scolapiatti in silicone | | |
| CHF 125.– 40.001.138.00 | CHF 51.– 40.002.008.00 | | |

Varianten: Für das Unterbau-Becken Vantis mit Standard Zugknopf Prime Chrom bestellen Sie
xx.xxx.xx.01 Standardartikel ohne Zugknopf. Reduktion CHF 24.–. Im Austausch wählen Sie den gewünschten Zugknopf auf Seite 358.
Varianti: per il lavello sottopiano Vantis con pomolo standard Prime cromato, ordinate
xx.xxx.xx.01 – Articolo standard senza pomolo. Riduzione di CHF 24.–. In sostituzione, scegliete il pomolo desiderato a pagina 358.

Preis CHF/Prezzo in CHF

Modell Modello	Material Materiale	Ventil Piletta	Artikel-Nr. N. di articolo	Beckentiefe Profondità	Exkl. MWST IVA esclusa	Inkl. MWST IVA inclusa
Vantis VX 50-42U Varix	Edelstahl, mid-matt Acciaio inox, mid-matt	18/10	3 1/2" Raumspar Salvaspazio	10.103.960.00	160 mm	A 699.– 756.–
			3 1/2" Siebstopfen A tappo con griglietta	10.103.961.00	160 mm	A 658.– 711.–

Vantis: VX 55U Varix

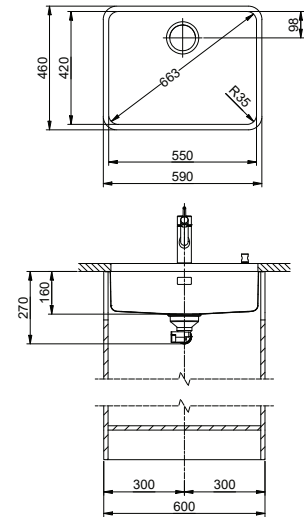

Verdeckter Überlauf
Troppopieno coperto

27



Zeichnung als pdf/dxf und Montageanleitung siehe:
V. disegno in formato pdf/dxf e montaggio:
suter.ch

Optionales Zubehör / Accessori opzionali

310



Resteschale gelocht
Vaschetta forata

CHF 106.– 40.000.914.00

Resteschale ungelocht
Vaschetta non forata

CHF 106.– 40.001.290.00

Schneidebrett aus Glas
Tagliere in vetro

CHF 151.– 40.000.915.00

Holz-Schneidebrett aus Nussbaum
Tagliere in legno di noce

CHF 151.– 40.001.147.00

Inox Pad

CHF 125.– 40.001.138.00

Maro Abtropfmatte aus Silikon
Maro tappetino scolapiatti in silicone

CHF 51.– 40.002.008.00



Varianten: Für das Unterbau-Becken Vantis mit Standard Zugknopf Prime Chrom bestellen Sie

xx.xxx.xx.01 Standardartikel ohne Zugknopf. Reduktion CHF 24.–. Im Austausch wählen Sie den gewünschten Zugknopf auf Seite 358.

Varianti: per il lavello sottopiano Vantis con pomolo standard Prime cromato, ordinate

xx.xxx.xx.01 – Articolo standard senza pomolo. Riduzione di CHF 24.–. In sostituzione, scegliete il pomolo desiderato a pagina 358.

Preis CHF/Prezzo in CHF

Modell Modello	Material Materiale	Ventil Piletta	Artikel-Nr. N. di articolo	Beckentiefe Profondità	Exkl. MWST IVA esclusa	Inkl. MWST IVA inclusa
Vantis VX 55U Varix	Edelstahl, mid-matt Acciaio inox, mid-matt	3 1/2" Raumspar Salvaspazio	10.104.145.00	160 mm	A 744.–	804.–
		3 1/2" Siebstopfen A tappo con griglietta	10.104.146.00	160 mm	A 703.–	760.–



Vantis: VX 50-42U Varix



Vantis: VX 55U Varix

Silver Star: SIL 18U + SIL 34U

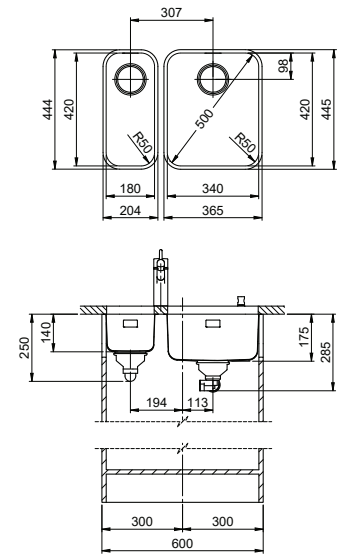

Verdeckter Überlauf
Trooppieno coperto

27

Obenliegendes Sieb
Griglietta superiore

26



Zeichnung als pdf/dxf und Montageanleitung siehe:
V. disegno in formato pdf/dxf e montaggio:
suter.ch

Optionales Zubehör / Accessori opzionali

310



Resteschale gelocht
Vaschetta forato
CHF 106.- 40.000.914.00

Resteschale ungelocht
Vaschetta non forato
CHF 106.- 40.001.290.00

Schneidebrett aus Glas
Tagliere in vetro
CHF 151.- 40.000.915.00

Holz-Schneidebrett aus Nussbaum
Tagliere in legno di noce
CHF 151.- 40.001.147.00

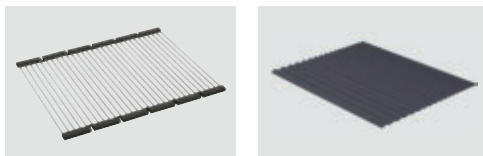

Inox Pad
CHF 125.- 40.001.138.00

Maro Abtropfmatte aus Silikon
Maro tappetino scolapiatti in silicone
CHF 51.- 40.002.008.00

**Wählen Sie den Oberflächenfinish:**

In den Ausführungen glanz und matt erhältlich.

Scegliete la finitura:

Disponibile nelle finiture lucido e opaco.



Beim Set SIL 18U + SIL 34U ist die Resteschale aus Edelstahl, gelocht, im Preis inbegriffen.

Il prezzo del set SIL 18U + SIL 34U è comprensivo della vaschetta in acciaio inox, forato.



Varianten: Für das Unterbau-Becken Silver Satr mit Standard Zugknopf Prime Chrom bestellen Sie
 xx.xxx.xx.01 Standardartikel ohne Zugknopf. Reduktion CHF 24.-. Im Austausch wählen Sie den gewünschten Zugknopf auf Seite 358.
Varianti: per il lavello sottopiano Silver Star con pomolo standard Prime cromato, ordinate
 xx.xxx.xx.01 – Articolo standard senza pomolo. Riduzione di CHF 24.-. In sostituzione, scegliete il pomolo desiderato a pagina 358.

Preis CHF/Prezzo in CHF

Modell Modello	Material Materiale	Ventil Piletta	Artikel-Nr. N. di articolo	Beckentiefe Profondità	Exkl. MWST IVA esclusa	Inkl. MWST IVA inclusa
Silver Star SIL 18U	Edelstahl, matt Acciaio inox, opaco	18/10 3 ½" Tipo	10.102.117.00	140 mm A	546.–	590.–
	Edelstahl, glanz Acciaio inox, lucido	18/10 3 ½" Tipo	10.103.610.00	140 mm A	546.–	590.–
Silver Star SIL 34U	Edelstahl, matt Acciaio inox, opaco	18/10 3 ½" Raumspar Salvaspazio	10.102.118.00	175 mm A	708.–	765.–
		18/10 3 ½" Tipo	10.103.085.00	175 mm A	667.–	721.–
	Edelstahl, glanz Acciaio inox, lucido	18/10 3 ½" Raumspar Salvaspazio	10.103.612.00	175 mm A	708.–	765.–
		18/10 3 ½" Tipo	10.103.613.00	175 mm A	667.–	721.–
Silver Star SIL 18U + Silver Star SIL 34U	Edelstahl, matt Acciaio inox, opaco	18/10 3 ½" Tipo + Raumspar Tipo + Salvaspazio	10.102.567.00	140 mm 175 mm A	1216.–	1314.–
		18/10 3 ½" Tipo + Tipo	10.103.086.00	140 mm 175 mm A	1175.–	1270.–
inklusive Resteschale Panier amovibile inclusa	Edelstahl, glanz Acciaio inox, lucido	18/10 3 ½" Tipo + Raumspar Tipo + Salvaspazio	10.103.615.00	140 mm 175 mm A	1216.–	1314.–
		18/10 3 ½" Tipo + Tipo	10.103.616.00	140 mm 175 mm A	1175.–	1270.–

Unterbau-Becken
Lavelli sottopiano



Silver Star: SIL 18U + SIL 34U

Silver Star: SIL 18/34U

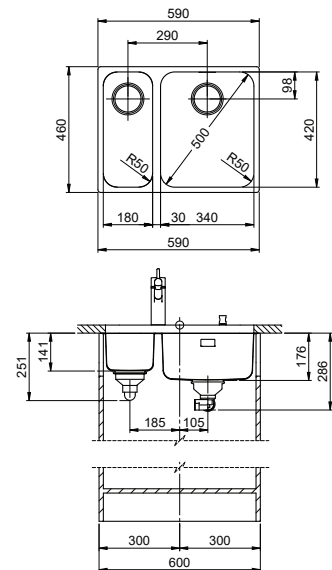

 Verdeckter Überlauf
Troppieno coperto

27

 Obenliegendes Sieb
Griglietta superiore

26



Zeichnung als pdf/dxf und Montageanleitung siehe:
V. disegno in formato pdf/dxf e montaggio:
suter.ch

Optionales Zubehör / Accessori opzionali

310



Resteschale gelocht
Vaschetta forato
CHF 106.- 40.000.914.00



Resteschale ungelocht
Vaschetta non forato
CHF 106.- 40.001.290.00

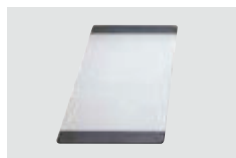

Schneidebrett aus Glas
Tagliere in vetro
CHF 151.- 40.000.915.00



Holz-Schneidebrett aus Nussbaum
Tagliere in legno di noce
CHF 151.- 40.001.147.00

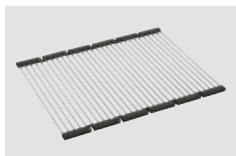

Inox Pad
CHF 125.- 40.001.138.00

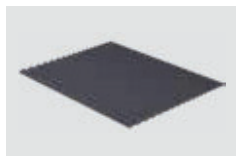

Maro Abtropfmatte aus Silikon
Maro tappetino scolapiatti in silicone
CHF 51.- 40.002.008.00

**Wählen Sie den Oberflächenfinish:**

In den Ausführungen glanz und matt erhältlich.

Scegliete la finitura:

Disponibile nelle finiture lucido e opaco.



Varianten: Für das Unterbau-Becken Silver Satr mit Standard Zugknopf Prime Chrom bestellen Sie
 xx.xxx.xx.01 Standardartikel ohne Zugknopf. Reduktion CHF 24.-. Im Austausch wählen Sie den gewünschten Zugknopf auf Seite 358.
Varianti: per il lavello sottopiano Silver Star con pomolo standard Prime cromato, ordinate
 xx.xxx.xx.01 – Articolo standard senza pomolo. Riduzione di CHF 24.-. In sostituzione, scegliete il pomolo desiderato a pagina 358.

Preis CHF/Prezzo in CHF

Modell Modello	Material Materiale	Ventil Piletta	Artikel-Nr. N. di articolo	Restebecken Vasca per raccolta residui	Exkl. MWST IVA esclusa	Inkl. MWST IVA inclusa	
Silver Star SIL 18/34U	Edelstahl, matt Acciaio inox, opaco	18/10	3 1/2" Tipo + Raumspar Tipo + Salvaspazio	10.102.667.00	Links/Sinistra	A 1261.–	1363.–
			3 1/2" Tipo + Tipo	10.103.092.00		A 1220.–	1319.–
	Edelstahl, glanz Acciaio inox, lucido	18/10	3 1/2" Tipo + Raumspar Tipo + Salvaspazio	10.103.618.00	Links/Sinistra	A 1261.–	1363.–
			3 1/2" Tipo + Tipo	10.103.619.00		A 1220.–	1319.–
Silver Star SIL 34/18U	Edelstahl, matt Acciaio inox, opaco	18/10	3 1/2" Raumspar + Tipo Salvaspazio + Tipo	10.102.668.00	Rechts/ Destra	A 1261.–	1363.–
			3 1/2" Tipo + Tipo	10.103.093.00		A 1220.–	1319.–
	Edelstahl, glanz Acciaio inox, lucido	18/10	3 1/2" Raumspar + Tipo Salvaspazio + Tipo	10.103.621.00	Rechts/ Destra	A 1261.–	1363.–
			3 1/2" Tipo + Tipo	10.103.622.00		A 1220.–	1319.–

Unterbau-Becken
Lavelli sottopiano



Silver Star: SIL 18/34U

Silver Star: SIL 45U

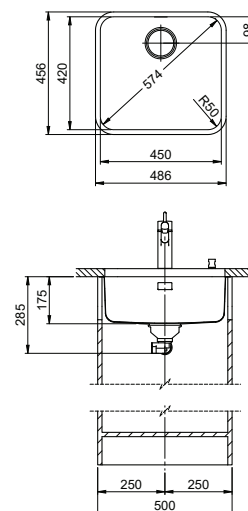

Verdeckter Überlauf
Troppopieno coperto

27

Obenliegendes Sieb
Griglietta superiore

26



Zeichnung als pdf/dxf und Montageanleitung siehe:
V. disegno in formato pdf/dxf e montaggio:
suter.ch

Optionales Zubehör / Accessori opzionali

310



Resteschale gelocht
Vaschetta forata

CHF 106.– 40.000.914.00



Resteschale ungelocht
Vaschetta non forata

CHF 106.– 40.001.290.00

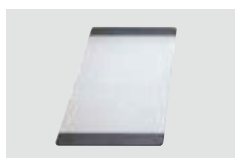

Schneidebrett aus Glas
Tagliere in vetro

CHF 151.– 40.000.915.00



Holz-Schneidebrett aus Nussbaum
Tagliere in legno di noce

CHF 151.– 40.001.147.00



Wählen Sie den Oberflächenfinish:

In den Ausführungen glanz und matt erhältlich.

Scegliete la finitura:

Disponibile nelle finiture lucido e opaco.

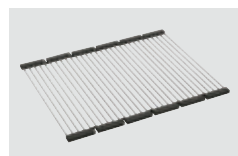

Inox Pad

CHF 125.– 40.001.138.00

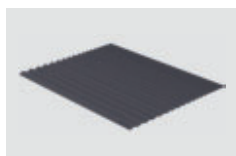

Maro Abtropfmatte aus Silikon
Maro tappetino scolapiatti in silicone

CHF 51.– 40.002.008.00

Varianten: Für das Unterbau-Becken Silver Star mit Standard Zugknopf Prime Chrom bestellen Sie
xx.xxx.xx.01 Standardartikel ohne Zugknopf. Reduktion CHF 24.–. Im Austausch wählen Sie den gewünschten Zugknopf auf Seite 358.
Varianti: per il lavello sottopiano Silver Star con pomolo standard Prime cromato, ordinate
xx.xxx.xx.01 – Articolo standard senza pomolo. Riduzione di CHF 24.–. In sostituzione, scegliete il pomolo desiderato a pagina 358.

Preis CHF / Prezzo in CHF

Modell Modello	Material Materiale	Ventil Piletta	Artikel-Nr. N. di articolo	Beckentiefe Profondità	Exkl. MWST IVA esclusa	Inkl. MWST IVA inclusa
Silver Star SIL 45U	Edelstahl, matt Acciaio inox, opaco	3 1/2" Raumspar Salvaspazio	10.102.669.00	175 mm	A	729.– 788.–
		3 1/2" Tipo	10.102.979.00	175 mm	A	680.– 735.–
	Edelstahl, glanz Acciaio inox, lucido	3 1/2" Raumspar Salvaspazio	10.102.811.00	175 mm	A	729.– 788.–
		3 1/2" Tipo	10.102.980.00	175 mm	A	680.– 735.–
		3 1/2" Raumspar Salvaspazio	10.103.087.00	120 mm*	A	1146.– 1239.–

* Modell ist mit Überlaufschlitzen und Ablauf Typ C ausgestattet. / Modello dotato di fessure troppopieno e scarico tipo C.

Silver Star: SIS 50U

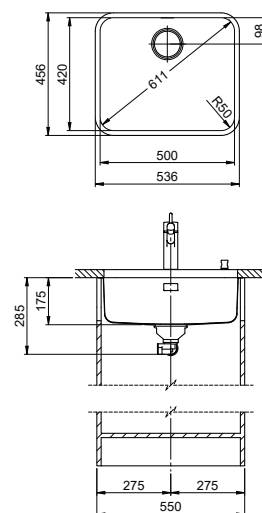

Verdeckter Überlauf
Trooppieno coperto

27

Obenliegendes Sieb
Griglietta superiore

26



Zeichnung als pdf/dxf und Montageanleitung siehe:
V. disegno in formato pdf/dxf e montaggio:
suter.ch

Optionales Zubehör / Accessori opzionali

310



Resteschale gelocht
Vaschetta forata
CHF 106.– 40.000.914.00

Resteschale ungelocht
Vaschetta non forata
CHF 106.– 40.001.290.00

Schneidebrett aus Glas
Tagliere in vetro
CHF 151.– 40.000.915.00

Holz-Schneidebrett aus Nussbaum
Tagliere in legno di noce
CHF 151.– 40.001.147.00

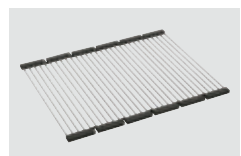

Innox Pad
CHF 125.– 40.001.138.00

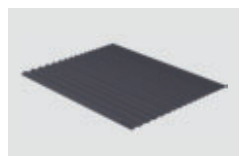

Maro Abtropfmatte aus Silikon
Maro tappetino scolapiatti in silicone
CHF 51.– 40.002.008.00

Wählen Sie den Oberflächenfinish:
In den Ausführungen glanz und matt erhältlich.
Scegliete la finitura:
Disponibile nelle finiture lucido e opaco.

Varianten: Für das Unterbau-Becken Silver Star mit Standard Zugknopf Prime Chrom bestellen Sie
xx.xxx.xx.01 Standardartikel ohne Zugknopf. Reduktion CHF 24.–. Im Austausch wählen Sie den gewünschten Zugknopf auf Seite 358.
Varianti: per il lavello sottopiano Silver Star con pomolo standard Prime cromato, ordinate
xx.xxx.xx.01 – Articolo standard senza pomolo. Riduzione di CHF 24.–. In sostituzione, scegliete il pomolo desiderato a pagina 358.

Preis CHF/Prezzo in CHF

Modell Modello	Material Materiale	Ventil Piletta	Artikel-Nr. N. di articolo	Beckentiefe Profondità	Exkl. MWST IVA esclusa	Inkl. MWST IVA inclusa
Silver Star SIS 50U	Edelstahl, matt Acciaio inox, opaco	18/10 3 1/2" Raumspar Salvaspazio	10.102.670.00	175 mm	A 912.–	986.–
		3 1/2" Tipo	10.102.981.00	175 mm	A 863.–	933.–
	Edelstahl, glanz Acciaio inox, lucido	18/10 3 1/2" Raumspar Salvaspazio	10.102.812.00	175 mm	A 912.–	986.–
		3 1/2" Tipo	10.102.982.00	175 mm	A 863.–	933.–

Silver Star: SIL 50U + SIL 9U

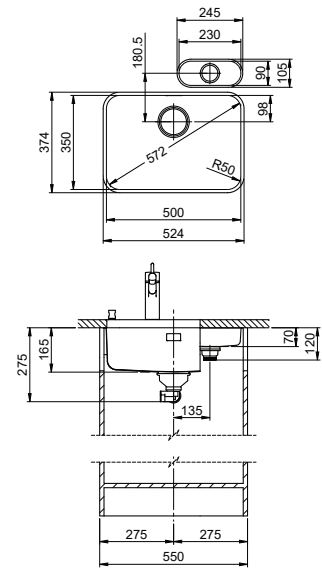

 Verdeckter Überlauf
Trooppieno coperto

27

 Obenliegendes Sieb
Griglietta superiore

26



Zeichnung als pdf/dxf und Montageanleitung siehe:
V. disegno in formato pdf/dxf e montaggio:
suter.ch

Optionales Zubehör / Accessori opzionali

310



Resteschale zu SIL 9U
Vaschetta per SIL 9U
CHF 81.- 40.000.042.00



Resteschale gelocht
Vaschetta forato
CHF 106.- 40.000.916.00

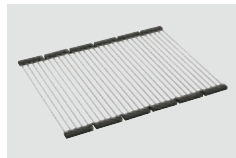

Inox Pad
CHF 125.- 40.001.139.00

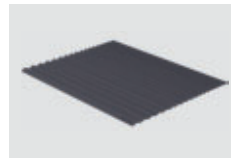

Maro Abtropfmatte aus Silikon
Maro tappetino scolapiatti in silicone
CHF 51.- 40.002.008.00

**Wählen Sie den Oberflächenfinish:**

In den Ausführungen glanz und matt erhältlich.

Scegliete la finitura:

Disponibile nelle finiture lucido e opaco.



Varianten: Für das Unterbau-Becken Silver Satr mit Standard Zugknopf Prime Chrom bestellen Sie
 xx.xxx.xx.01 Standardartikel ohne Zugknopf. Reduktion CHF 24.–. Im Austausch wählen Sie den gewünschten Zugknopf auf Seite 358.
Varianti: per il lavello sottopiano Silver Star con pomolo standard Prime cromato, ordinate
 xx.xxx.xx.01 – Articolo standard senza pomolo. Riduzione di CHF 24.–. In sostituzione, scegliete il pomolo desiderato a pagina 358.

Preis CHF/Prezzo in CHF

Modell Modello	Material Materiale	Ventil Piletta	Artikel-Nr. N. di articolo	Beckentiefe Profondità	Exkl. MWST IVA esclusa	Inkl. MWST IVA inclusa
Silver Star SIL 50U	Edelstahl, matt Acciaio inox, opaco	18/10 3 1/2" Raumspar Salvaspazio	10.102.561.00	165 mm	A 709.–	766.–
		3 1/2" Tipo	10.102.564.00	165 mm	A 660.–	713.–
	Edelstahl, glanz Acciaio inox, lucido	18/10 3 1/2" Raumspar Salvaspazio	10.102.813.00	165 mm	A 709.–	766.–
		3 1/2" Tipo	10.102.814.00	165 mm	A 660.–	713.–
Silver Star SIL 9U	Edelstahl, matt Acciaio inox, opaco	18/10 1 1/2" Stopfen A tappo	10.102.671.00	70 mm	A 315.–	341.–
	Edelstahl, glanz Acciaio inox, lucido	18/10 1 1/2" Stopfen A tappo	10.102.836.00	70 mm	A 315.–	341.–
Silver Star SIL 50U + Silver Star SIL 9U	Edelstahl, matt Acciaio inox, opaco	18/10 3 1/2" Raumspar + Salvaspazio	10.102.672.00	165 mm 70 mm	A 993.–	1073.–
		1 1/2" Stopfen A tappo				
		3 1/2" Tipo +	10.103.131.00	165 mm 70 mm	A 944.–	1020.–
		1 1/2" Stopfen A tappo				
	Edelstahl, glanz Acciaio inox, lucido	18/10 3 1/2" Raumspar + Salvaspazio	10.102.815.00	165 mm 70 mm	A 993.–	1073.–
		1 1/2" Stopfen A tappo				
		18/10 3 1/2" Tipo +	10.103.130.00	165 mm 70 mm	A 944.–	1020.–
		1 1/2" Stopfen A tappo				



Silver Star: SIL 50U + SIL 9U



Silver Star: SIL 50U

Silver Star: SIL 55U

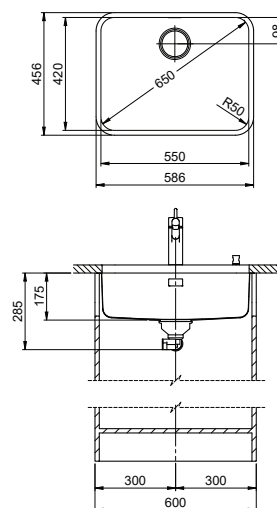

Verdeckter Überlauf
Troppieno coperto

27

Obenliegendes Sieb
Griglietta superiore

26



Zeichnung als pdf/dxf und Montageanleitung siehe:
V. disegno in formato pdf/dxf e montaggio:
suter.ch

Optionales Zubehör / Accessori opzionali

310



Resteschale gelocht
Vaschetta forata
CHF 106.– 40.000.914.00

Resteschale ungelocht
Vaschetta non forata
CHF 106.– 40.001.290.00

Schneidebrett aus Glas
Tagliere in vetro
CHF 151.– 40.000.915.00

Holz-Schneidebrett aus Nussbaum
Tagliere in legno di noce
CHF 151.– 40.001.147.00

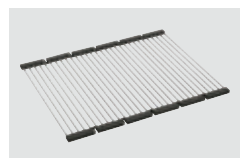

Innox Pad
CHF 125.– 40.001.138.00

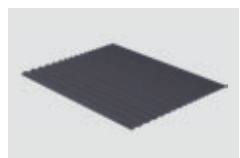

Maro Abtropfmatte aus Silikon
Maro tappetino scolapiatti in silicone
CHF 51.– 40.002.008.00

Wählen Sie den Oberflächenfinish:
In den Ausführungen glanz und matt erhältlich.
Scegliete la finitura:
Disponibile nelle finiture lucido e opaco.

Varianten: Für das Unterbau-Becken Silver Star mit Standard Zugknopf Prime Chrom bestellen Sie
xx.xxx.xx.01 Standardartikel ohne Zugknopf. Reduktion CHF 24.–. Im Austausch wählen Sie den gewünschten Zugknopf auf Seite 358.
Varianti: per il lavello sottopiano Silver Star con pomolo standard Prime cromato, ordinate
xx.xxx.xx.01 – Articolo standard senza pomolo. Riduzione di CHF 24.–. In sostituzione, scegliete il pomolo desiderato a pagina 358.

Preis CHF/Prezzo in CHF

Modell Modello	Material Materiale	Ventil Piletta	Artikel-Nr. N. di articolo	Beckentiefe Profondità	Exkl. MWST IVA esclusa	Inkl. MWST IVA inclusa
Silver Star SIL 55U	Edelstahl, matt Acciaio inox, opaco	3 1/2" Raumspar Salvaspazio	10.103.288.00	175 mm	A 1122.–	1213.–
		3 1/2" Tipo	10.103.289.00	175 mm	A 1081.–	1169.–
	Edelstahl, glanz Acciaio inox, lucido	3 1/2" Raumspar Salvaspazio	10.103.286.00	175 mm	A 1122.–	1213.–
		3 1/2" Tipo	10.103.287.00	175 mm	A 1081.–	1169.–

Silver Star: SX 40U Varix

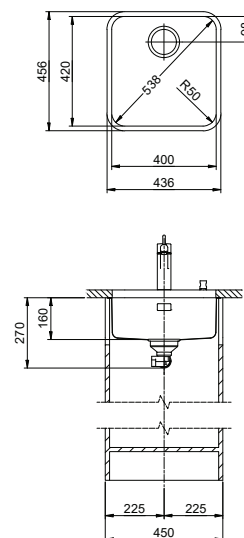

Verdeckter Überlauf, ohne Montagehalterung
Troppieno coperto, senza staffa di montaggio



Zeichnung als pdf/ dxf und Montageanleitung siehe:
V. disegno in formato pdf/ dxf e montaggio:
suter.ch

Optionales Zubehör / Accessori opzionali



Resteschale gelocht
Vaschetta forata
CHF 106.– 40.000.914.00



Resteschale ungelocht
Vaschetta non forata
CHF 106.– 40.001.290.00

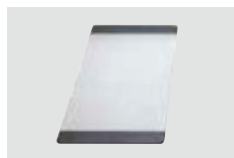

Schneidebrett aus Glas
Tagliere in vetro
CHF 151.– 40.000.915.00



Holz-Schneidebrett aus Nussbaum
Tagliere in legno di noce
CHF 151.– 40.001.147.00

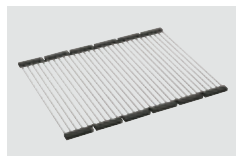

Inox Pad
CHF 125.– 40.001.138.00

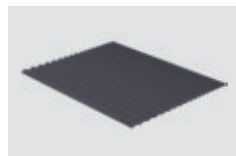

Maro Abtropfmatte aus Silikon
Maro tappetino scolapiatti in silicone
CHF 51.– 40.002.008.00

Preis CHF / Prezzo in CHF

Modell Modello	Material Materiale	Ventil Piletta	Artikel-Nr. N. di articolo	Beckentiefe Profondità	Exkl. MWST IVA esclusa	Inkl. MWST IVA inclusa
Silver Star SX 40U Varix	Edelstahl, mid-matt Eco Acciaio inox, mid-opaco Eco	3 1/2" Raumspar Salvaspazio	10.105.318.00	160 mm	A 598.–	646.–
		3 1/2" Siebstopfen A tappo c. griglietta	10.105.319.00	160 mm	A 557.–	602.–

Silver Star: SX 50-42U Varix

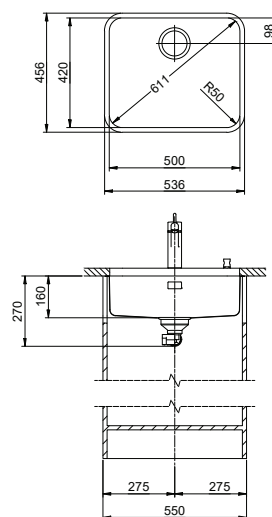

Verdeckter Überlauf, ohne Montagehalterung
Troppieno coperto, senza staffa di montaggio



Zeichnung als pdf/dxf und Montageanleitung siehe:
V. disegno in formato pdf/dxf e montaggio:
suter.ch

Optionales Zubehör / Accessori opzionali



Resteschale gelocht
Vaschetta forato
CHF 106.– 40.000.914.00



Resteschale ungelocht
Vaschetta non forato
CHF 106.– 40.001.290.00

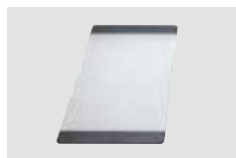

Schneidebrett aus Glas
Tagliere in vetro
CHF 151.– 40.000.915.00



Holz-Schneidebrett aus Nussbaum
Tagliere in legno di noce
CHF 151.– 40.001.147.00

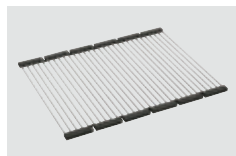

Inox Pad
CHF 125.– 40.001.138.00

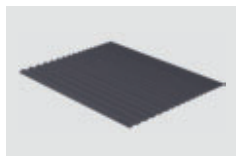

Maro Abtropfmatte aus Silikon
Maro tappetino scolapiatti in silicone
CHF 51.– 40.002.008.00

Preis CHF / Prezzo in CHF

Modell Modello	Material Materiale	Ventil Piletta	Artikel-Nr. N. di articolo	Beckentiefe Profondità	Exkl. MWST IVA esclusa	Inkl. MWST IVA inclusa
Silver Star SX 50-42U Varix	Edelstahl, mid-matt Eco 18/10 Acciaio inox, mid-opaco Eco	3 1/2" Raumspar Salvaspazio	10.105.316.00	160 mm	A 639.–	691.–
		3 1/2" Siebstopfen A tappo c. griglietta	10.105.317.00	160 mm	A 598.–	646.–

Comfort: COM 34U

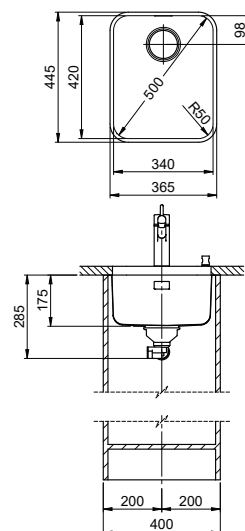

Verdeckter Überlauf
Troppipieno coperto

27

Obenliegendes Sieb
Griglietta superiore

26



Zeichnung als pdf/dxf und Montageanleitung siehe:
V. disegno in formato pdf/dxf e montaggio:
suter.ch

Optionales Zubehör / Accessori opzionali

310



Resteschale gelocht
Vaschetta forato

CHF 106.– 40.000.971.00

Schneidebrett aus Glas
Tagliere in vetro

CHF 151.– 40.000.915.00

Inox Pad

CHF 125.– 40.001.138.00

Maro Abtropfmatte aus Silikon
Maro tappetino scolapiatti in silicone

CHF 51.– 40.002.008.00

Varianten: Für das Unterbau-Becken Comfort mit Standard Zugknopf Prime Chrom bestellen Sie
xx.xxx.xx.01 Standardartikel ohne Zugknopf. Reduktion CHF 24.–. Im Austausch wählen Sie den gewünschten Zugknopf auf Seite 358.
Varianti: per il lavello sottopiano Comfort con pomolo standard Prime cromato, ordinate
xx.xxx.xx.01 – Articolo standard senza pomolo. Riduzione di CHF 24.–. In sostituzione, scegliete il pomolo desiderato a pagina 358.

Preis CHF/Prezzo in CHF

Modell Modello	Material Materiale	Ventil Piletta	Artikel-Nr. N. di articolo	Beckentiefe Profondità	Exkl. MWST IVA esclusa	Inkl. MWST IVA inclusa	
Comfort COM 34U	Edelstahl, glanz Acciaio inox, lucido	3 1/2" Raumspar Salvaspazio	10.102.753.00	175 mm	A	708.–	765.–
		3 1/2" Tipo	10.103.098.00	175 mm	A	667.–	721.–
		1 1/2" Standrohr Con tubo	10.102.752.00	175 mm	A	558.–	603.–

Comfort: COM 40U

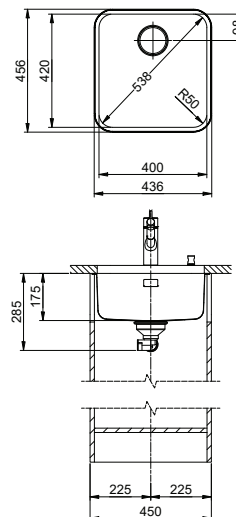

Verdeckter Überlauf
Troppopieno coperto

27

Obenliegendes Sieb
Griglietta superiore

26



Zeichnung als pdf/dxf und Montageanleitung siehe:
V. disegno in formato pdf/dxf e montaggio:
suter.ch

Optionales Zubehör / Accessori opzionali

310



Resteschale gelocht
Vaschetta forata

CHF 106.- 40.000.914.00

Resteschale ungelocht
Vaschetta non forata

CHF 106.- 40.001.290.00

Schneidebrett aus Glas
Tagliere in vetro

CHF 151.- 40.000.915.00

Holz-Schneidebrett aus Nussbaum
Tagliere in legno di noce

CHF 151.- 40.001.147.00

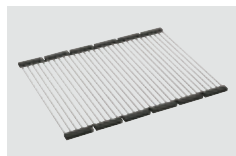

Innox Pad

CHF 125.- 40.001.138.00

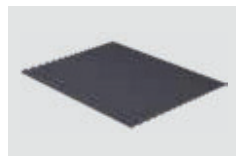

Maro Abtropfmatte aus Silikon
Maro tappetino scolapiatti in silicone

CHF 51.- 40.002.008.00

Varianten: Für das Unterbau-Becken Comfort mit Standard Zugknopf Prime Chrom bestellen Sie
xx.xxx.xx.01 Standardartikel ohne Zugknopf. Reduktion CHF 24.-. Im Austausch wählen Sie den gewünschten Zugknopf auf Seite 358.
Varianti: per il lavello sottopiano Comfort con pomolo standard Prime cromato, ordinate
xx.xxx.xx.01 – Articolo standard senza pomolo. Riduzione di CHF 24.-. In sostituzione, scegliete il pomolo desiderato a pagina 358.

Preis CHF/Prezzo in CHF

Modell Modello	Material Materiale	Ventil Piletta	Artikel-Nr. N. di articolo	Beckentiefe Profondità	Exkl. MWST IVA esclusa	Inkl. MWST IVA inclusa	
Comfort: COM 40U	Edelstahl, glanz Acciaio inox, lucido	18/10	3 1/2" Raumspar Salvaspazio	10.103.272.00	175 mm	A 802.-	867.-
			3 1/2" Tipo	10.103.273.00	175 mm	A 761.-	823.-

Accento: A 65U

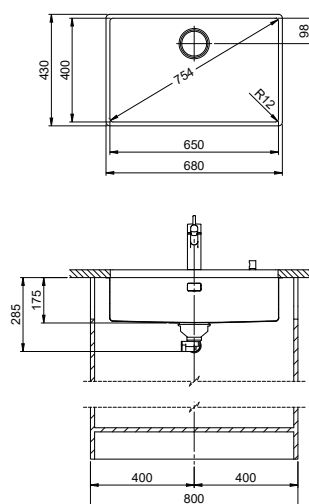

Schwenkbare Überlaufkappe
Placchetta di troppopieno a ribalta

27

Obenliegendes Sieb
Griglietta superiore

26



Zeichnung als pdf/dxf und Montageanleitung siehe:
V. disegno in formato pdf/dxf e montaggio:
suter.ch

Optionales Zubehör / Accessori opzionali

310

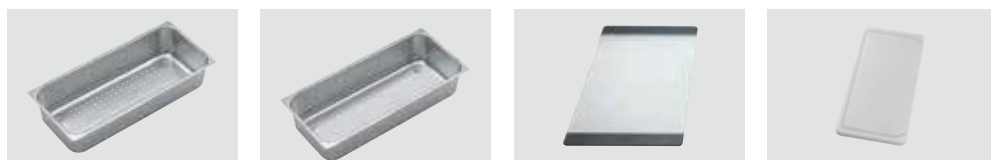

Resteschale gelocht
Vaschetta forata
CHF 106.– 40.000.912.00

Resteschale ungelocht
Vaschetta non forata
CHF 106.– 40.001.289.00

Schneidebrett aus Glas
Tagliere in vetro
CHF 151.– 40.000.909.00

Schneidebrett aus Kunststoff
Tagliere sintetico
CHF 151.– 40.001.277.00

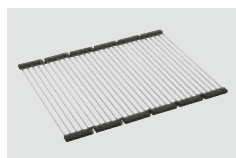

Inox Pad
CHF 125.– 40.001.138.00

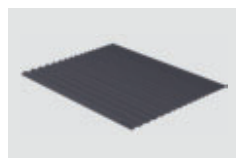

Maro Abtropfmatte aus Silikon
Maro tappetino scolapiatti in silicone
CHF 51.– 40.002.008.00

Alle Accento Modelle werden handgefertigt
Tutti i modelli Accento sono fabbricati a mano

Varianten: Für das Unterbau-Becken Accento mit Standard Zugknopf Advant Chrom bestellen Sie
xx.xxx.xx.01 Standardartikel ohne Zugknopf. Reduktion CHF 24.–. Im Austausch wählen Sie den gewünschten Zugknopf auf Seite 358.
Varianti: per il lavello sottopiano Accento con pomolo standard Advant cromato, ordinate
xx.xxx.xx.01 – Articolo standard senza pomolo. Riduzione di CHF 24.–. In sostituzione, scegliete il pomolo desiderato a pagina 358.

Preis CHF/Prezzo in CHF

Modell Modello	Material Materiale	Ventil Piletta	Artikel-Nr. N. di articolo	Beckentiefe Profondità	Exkl. MWST IVA esclusa	Inkl. MWST IVA inclusa	VRG TRA
Accento A 65U	Edelstahl, glanz Acciaio inox, lucido	18/10 3 1/2" TouchFlow	10.104.568.00	175 mm	A 1969.–	2128.–	0.19
		3 1/2" Raumspaar Salvaspazio	10.104.569.00	175 mm	A 1771.–	1914.–	
		3 1/2" Tipo	10.104.570.00	175 mm	A 1730.–	1870.–	

Accento: A 75U

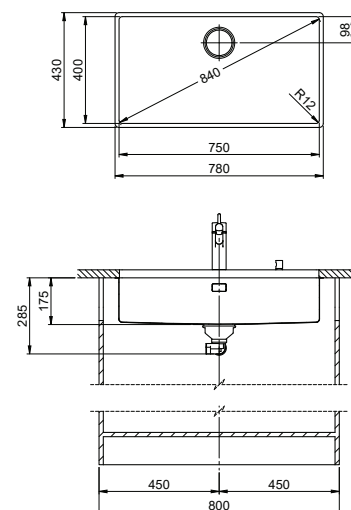
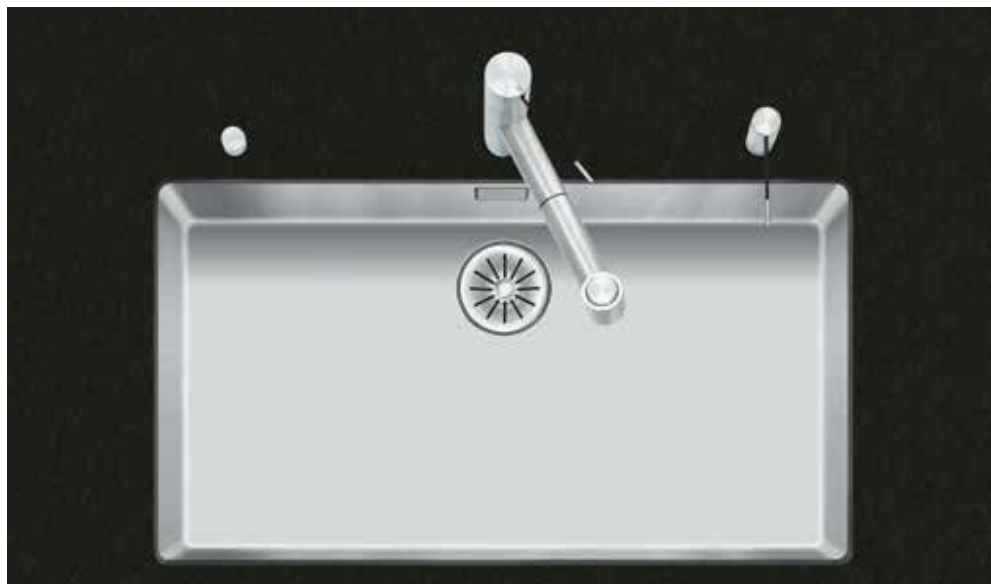

Schwenkbare Überlaufkappe
Placchetta di troppopieno a ribalta

27

Obenliegendes Sieb
Griglietta superiore

26



Zeichnung als pdf/dxf und Montageanleitung siehe:
V. disegno in formato pdf/dxf e montaggio:
suter.ch

Optionales Zubehör / Accessori opzionali

310

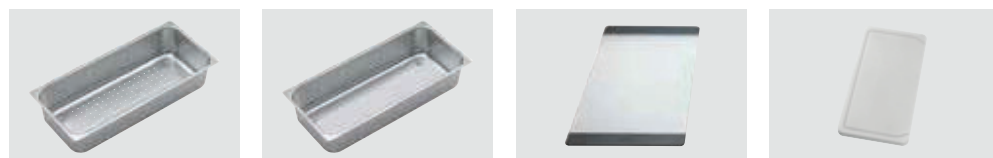

Resteschale gelocht
Vaschetta forato
CHF 106.– 40.000.912.00

Resteschale ungelocht
Vaschetta non forato
CHF 106.– 40.001.289.00

Schneidebrett aus Glas
Tagliere in vetro
CHF 151.– 40.000.909.00

Schneidebrett aus Kunststoff
Tagliere sintetico
CHF 151.– 40.001.277.00

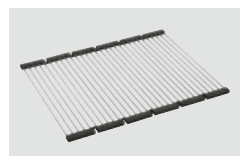

Inox Pad
CHF 125.– 40.001.138.00

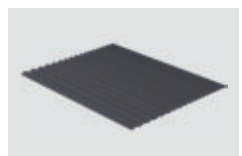

Maro Abtropfmatte aus Silikon
Maro tappetino scolapiatti in silicone
CHF 51.– 40.002.008.00

Alle Accento Modelle werden handgefertigt
Tutti i modelli Accento sono fabbricati a mano

Varianten: Für das Unterbau-Becken Accento mit Standard Zugknopf Advant Chrom bestellen Sie
xx.xxx.xx.01 Standardartikel ohne Zugknopf. Reduktion CHF 24.–. Im Austausch wählen Sie den gewünschten Zugknopf auf Seite 358.
Varianti: per il lavello sottopiano Accento con pomolo standard Advant cromato, ordinate
xx.xxx.xx.01 – Articolo standard senza pomolo. Riduzione di CHF 24.–. In sostituzione, scegliete il pomolo desiderato a pagina 358.

Preis CHF/Prezzo in CHF

Modell Modello	Material Materiale	Ventil Piletta	Artikel-Nr. N. di articolo	Beckentiefe Profondità	Exkl. MWST IVA esclusa	Inkl. MWST IVA inclusa	VRG TRA
Accento A 75U	Edelstahl, glanz Acciaio inox, lucido	18/10 3 1/2" TouchFlow	10.104.571.00	175 mm	A 2208.–	2387.–	0.19
		3 1/2" Raumspaar Salvaspazio	10.104.572.00	175 mm	A 2010.–	2173.–	
		3 1/2" Tipo	10.104.573.00	175 mm	A 1969.–	2128.–	

Accento: A 40/34U

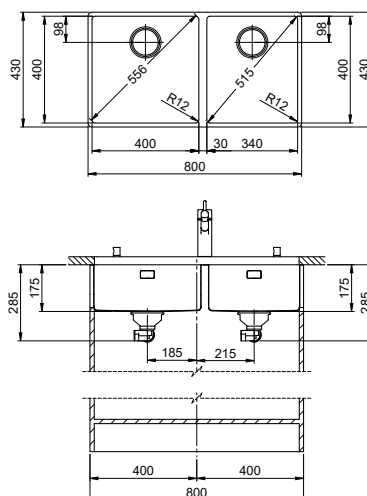

Schwenkbare Überlaufkappe
Placchetta di troppopieno a ribalta

27

Obenliegendes Sieb
Griglietta superiore

26



Zeichnung als pdf/dxf und Montageanleitung siehe:
V. disegno in formato pdf/dxf e montaggio:
suter.ch

Optionales Zubehör / Accessori opzionali

310

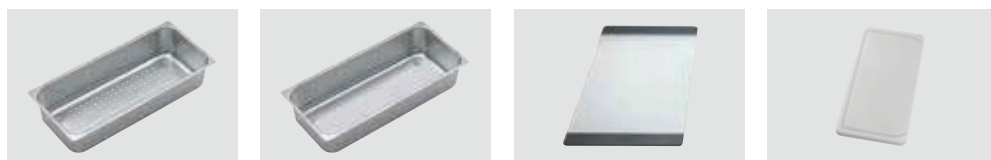

Resteschale gelocht
Vaschetta forato

CHF 106.– 40.000.912.00

Resteschale ungelocht
Vaschetta non forato

CHF 106.– 40.001.289.00

Schneidebrett aus Glas
Tagliere in vetro

CHF 151.– 40.000.909.00

Schneidebrett aus Kunststoff
Tagliere sintetico

CHF 151.– 40.001.277.00

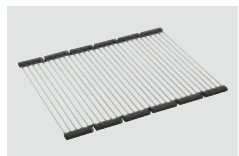

Innox Pad

CHF 125.– 40.001.138.00

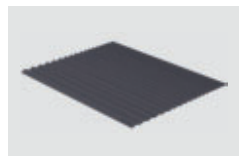

Maro Abtropfmatte aus Silikon
Maro tappetino scolapiatti in silicone

CHF 51.– 40.002.008.00

Alle Accento Modelle werden handgefertigt
Tutti i modelli Accento sono fabbricati a mano

Varianten: Für das Unterbau-Becken Accento mit Standard Zugknopf Advant Chrom bestellen Sie
xx.xxx.xx.01 Standardartikel ohne Zugknopf. Reduktion CHF 24.–. Im Austausch wählen Sie den gewünschten Zugknopf auf Seite 358.
Varianti: per il lavello sottopiano Accento con pomolo standard Advant cromato, ordinate
xx.xxx.xx.01 – Articolo standard senza pomolo. Riduzione di CHF 24.–. In sostituzione, scegliete il pomolo desiderato a pagina 358.

Preis CHF/Prezzo in CHF

Modell Modello	Material Materiale	Ventil Piletta	Artikel-Nr. N. di articolo	Beckentiefe Profondità	Exkl. MWST IVA esclusa	Inkl. MWST IVA inclusa	VRG TRA
Accento A 40/34U	Edelstahl, glanz Acciaio inox, lucido	18/10 3 1/2" TouchFlow	10.104.574.00	175 mm	A 3247.–	3510.–	0.19
		3 1/2" Raumspaar Salvaspazio	10.104.575.00	175 mm	A 2851.–	3082.–	
		3 1/2" Tipo	10.104.576.00	175 mm	A 2769.–	2993.–	

Gastro MaXX: MGM 1U + MGM 2U

(individuelle Beckengrösse möglich/dimensioni di lavello personalizzabili)

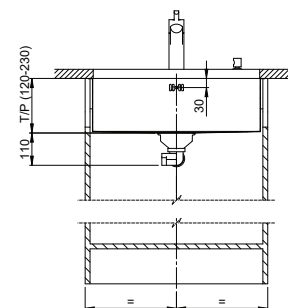
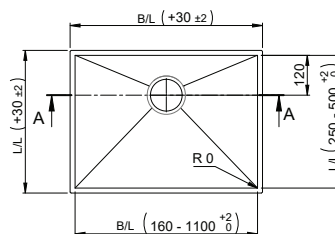

Zeichnung als pdf / dxf und Montageanleitung siehe:
V. disegno in formato pdf / dxf e montaggio:
suter.ch

Optionales Zubehör / Accessori opzionali



Resteschalen, Inox Pad, Schneidebretter nur für Standardmass L / L 350 / 400 / 420 mm, Sortiment siehe:
Vaschette, Inox Pad, taglieri solo L / L standard 350 / 400 / 420 mm, assortimento vedere:
suter.ch

Preis CHF / Prezzo in CHF

Modell Modello	Material Materiale	Ventil Piletta	Artikel-Nr. N. di articolo	Beckendimension in mm Dimensioni di lavello in mm			Exkl. MWST IVA esclusa	Inkl. MWST IVA inclusa		
Gastro MaXX MGM 1U*	Edelstahl, glanz Acciaio inox, lucido	18 / 10	3 1/2" Raumspar Salvaspazio	29.001.295.00	B / L 160-550	L / L 250-500	T / P 120-230	D	2332.-	2521.-
			3 1/2" Siebstopfen A tappo c. griglietta						29.001.296.00	2291.-
Gastro MaXX MGM 2U*	Edelstahl, glanz Acciaio inox, lucido	18 / 10	3 1/2" Raumspar Salvaspazio	29.001.297.00	>550-1100	250-500	120-230	D	3054.-	3301.-
			3 1/2" Siebstopfen A tappo c. griglietta						29.001.298.00	3013.-

* Wird nur auf Wunsch hergestellt – 3 Wochen Lieferfrist (kein Lagerartikel) / Producibile solo su richiesta – Termine di consegna di 3 settimane (articolo non a magazzino)
Die Gastro Maxx Modelle werden handgefertigt. / I modelli Gastro Maxx vengono fabbricati manualmente.
Für Bestellungen zum Gastro Maxx MGM verwenden Sie bitte das elektronische Bestellformular auf suter.ch. / Per ordinazioni riguardanti il Gastro Maxx MGM, vi preghiamo di utilizzare il modulo d'ordine elettronico disponibile sul sito suter.ch.

Rund: R 44BU

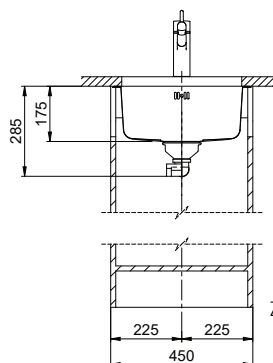
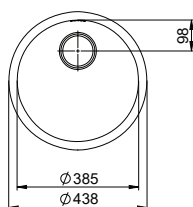

Zeichnung als pdf / dxf und Montageanleitung siehe:
V. disegno in formato pdf / dxf e montaggio:
suter.ch

Obenliegendes Sieb
Griglietta superiore



Varianten: Für das Unterbau-Becken Rund R mit Standard Zugknopf Prime Chrom bestellen Sie

xx.xxx.xx.01 Standardartikel ohne Zugknopf. Reduktion CHF 24.-. Im Austausch wählen Sie den gewünschten Zugknopf auf Seite 358.

Varianti: per il lavello sottopiano Rund R con pomolo standard Prime cromato, ordinate
xx.xxx.xx.01 – Articolo standard senza pomolo. Riduzione di CHF 24.-. In sostituzione, scegliete il pomolo desiderato a pagina 358.

Preis CHF / Prezzo in CHF

Modell Modello	Material Materiale	Ventil Piletta	Artikel-Nr. N. di articolo	Beckentiefe Profondità	Exkl. MWST IVA esclusa	Inkl. MWST IVA inclusa		
Rund R 44BU	Edelstahl, glanz Acciaio inox, lucido	18 / 10	3 1/2" Raumspar Salvaspazio	10.100.638.00	175 mm	A	874.-	945.-
			3 1/2" Tipo	10.103.132.00	175 mm	A	833.-	900.-



Linero: LIO CD 50U

SCHOCK
CRISTADUR®

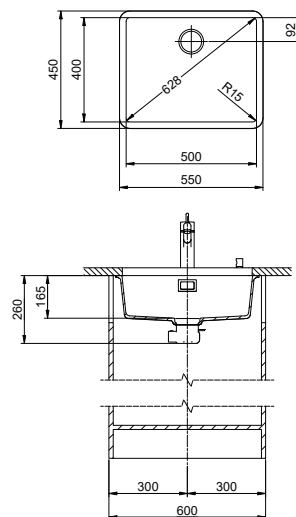
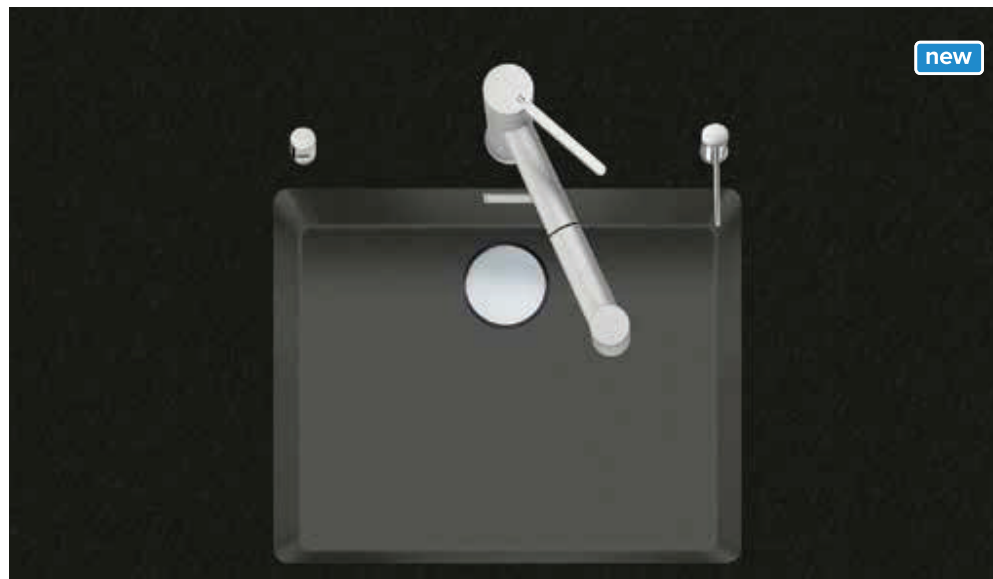

Schwenkbare Überlaufkappe
Placchetta di troppopieno a ribalta

27

Desino: Verdeckter Ablauf mit untenliegendem Sieb
Desino: Scarico coperto con griglietta inferiore

26



Für TouchFlow Desino und Raumspar Desino
Per TouchFlow Desino e Salvaspazio Desino

Für TouchFlow Desino und Raumspar Desino
Per TouchFlow Desino e Salvaspazio Desino

Zeichnung als pdf / dxf und Montageanleitung siehe:
V. disegno in formato pdf / dxf e montaggio:
suter.ch

Optionales Zubehör / Accessori opzionali

310

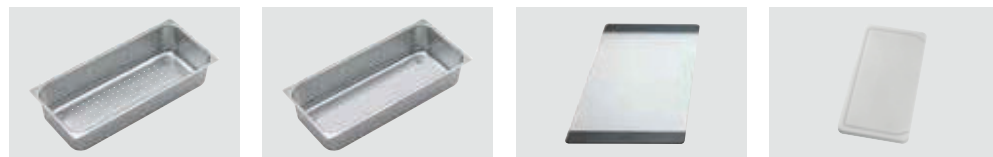

Resteschale gelocht
Vaschetta forato
CHF 106.- 40.000.912.00

Resteschale ungelocht
Vaschetta non forato
CHF 106.- 40.001.289.00

Schneidebrett aus Glas
Tagliere in vetro
CHF 151.- 40.000.909.00

Schneidebrett aus Kunststoff
Tagliere sintetico
CHF 151.- 40.001.277.00

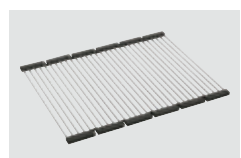

Inox Pad
CHF 125.- 40.001.138.00



Reinigungsset Easy Care
Kit di pulizia Easy Care
CHF 43.- / F 40.001.509.00



PVD-Beschichtung, Graphit
Rivestimento a PVD, grafite
3 1/2" TouchFlow
CHF 125.- / F 40.002.788.02



PVD-Beschichtung, Graphit
Rivestimento a PVD, grafite
3 1/2" Raumspar Desino / Salvaspazio Desino
CHF 125.- / F 40.002.767.02



DEC-Beschichtung, schwarz matt
Rivestimento a DEC, nero opaco
3 1/2" TouchFlow
CHF 140.- / F 40.002.789.02



DEC-Beschichtung, schwarz matt
Rivestimento a DEC, nero opaco
3 1/2" Raumspar Desino / Salvaspazio Desino
CHF 140.- / F 40.002.768.02

Mehrprijs für beschichtete Ventilbestandteile
TouchFlow Desino und Raumspar Desino: Ablaufsieb Desino, Überlaufblende und Überlaufkappe
Sovrapprezzo per componenti piletta rivestiti
TouchFlow Desino e Salvaspazio Desino: griglietta per lo scarico Desino, mascherina e tappo di troppopieno

Preis CHF/Prezzo in CHF

Modell Modello	Material Materiale	Ventil sFlow, Typ M Piletta sFlow, tipo M	Artikel-Nr. N. di articolo	Beckentiefe Profondità	Exkl. MWST IVA esclusa	Inkl. MWST IVA inclusa	VRG TAR	
LIO CD 50U Ausführung für 60-er Unterschrank/LIO CD 50U versione per una base di 60 cm								
Linero LIO CD 50U/1	Cristadur, Puro	3 1/2" TouchFlow Desino	10.105.282.00	165 mm	B	1559.–	1685.–	0.19
		3 1/2" Raumspar Desino Salvaspazio Desino	10.105.283.00	165 mm	B	1349.–	1458.–	
	Cristadur, Stone	3 1/2" TouchFlow Desino	10.105.294.00	165 mm	B	1559.–	1685.–	0.19
		3 1/2" Raumspar Desino Salvaspazio Desino	10.105.295.00	165 mm	B	1349.–	1458.–	
	Cristadur, Polaris	3 1/2" TouchFlow Desino	10.105.284.00	165 mm	B	1559.–	1685.–	0.19
		3 1/2" Raumspar Desino Salvaspazio Desino	10.105.285.00	165 mm	B	1349.–	1458.–	
LIO CD 50U Ausführung für 55-er Unterschrank/LIO CD 50U versione per una base di 55 cm								
Linero LIO CD 50U/2	Cristadur, Puro	3 1/2" TouchFlow Desino	10.105.310.00	165 mm	B	1626.–	1758.–	0.19
		3 1/2" Raumspar Desino Salvaspazio Desino	10.105.311.00	165 mm	B	1416.–	1531.–	
	Cristadur, Stone	3 1/2" TouchFlow Desino	10.105.314.00	165 mm	B	1626.–	1758.–	0.19
		3 1/2" Raumspar Desino Salvaspazio Desino	10.105.315.00	165 mm	B	1416.–	1531.–	
	Cristadur, Polaris	3 1/2" TouchFlow Desino	10.105.312.00	165 mm	B	1626.–	1758.–	0.19
		3 1/2" Raumspar Desino Salvaspazio Desino	10.105.313.00	165 mm	B	1416.–	1531.–	

Linero LIO CD 50U für 55-er Unterschrank
Linero LIO CD 50U per una base di 55 cm



Erfordert beidseitigen Ausschnitt der Korpuswand.
Richiede un intaglio della parete dell'armadio su entrambi i lati.

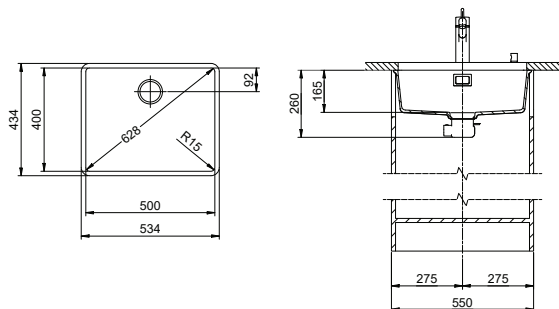

Zeichnung als pdf/dxf und Montageanleitung siehe:
V. disegno in formato pdf/dxf e montaggio:
suter.ch

Linero: LIO CDAB 50U Black Edition

SCHOCK
CRISTADUR®

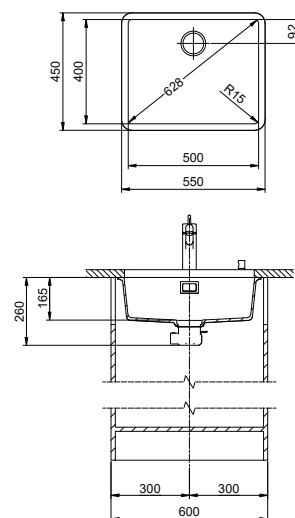

Schwenkbare Überlaufkappe
Placchetta di troppopieno a ribalta

27

Desino: Verdeckter Ablauf mit untenliegendem Sieb
Desino: Scarico coperto con griglietta inferiore

26



Für TouchFlow Desino und Raumspar Desino
Per TouchFlow Desino e Salvaspazio Desino

Für TouchFlow Desino und Raumspar Desino
Per TouchFlow Desino e Salvaspazio Desino

Zeichnung als pdf / dxf und Montageanleitung siehe:
V. disegno in formato pdf / dxf e montaggio:
suter.ch

Optionales Zubehör / Accessori opzionali

310

Resteschale gelocht Vaschetta forato CHF 106.– 40.000.912.00	Resteschale ungelocht Vaschetta non forato CHF 106.– 40.001.289.00	Schneidebrett aus Glas Tagliere in vetro CHF 151.– 40.000.909.00	Schneidebrett aus Kunststoff Tagliere sintetico CHF 151.– 40.001.277.00
Inox Pad CHF 125.– 40.001.138.00	Reinigungsset Easy Care Kit di pulizia Easy Care CHF 43.– / F 40.001.509.00		

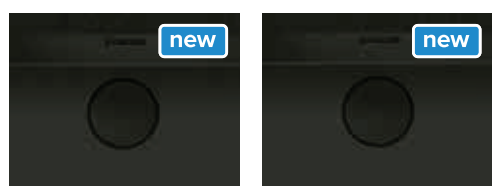





DEC-Beschichtung, schwarz matt
Rivestimento a DEC, nero opaco
3 1/2" TouchFlow Desino

DEC-Beschichtung, schwarz matt
Rivestimento a DEC, nero opaco
3 1/2" Raumspar Desino / Salvaspazio Desino

i Beschichtete Ventilbestandteile: im Preis inbegriffen
TouchFlow Desino und Raumspar Desino: Ablaufsieb Desino, Überlaufblende und Überlaufkappe
Raumspar Desino: bei der Black Edition ist der Zugknopf Advant (pulverbeschichtet, schwarz, matt) im Preis und Lieferumfang enthalten
Componenti piletta rivestiti: inclusi nel prezzo
TouchFlow Desino e Salvaspazio Desino: griglietta per lo scarico Desino, mascherina e tappo di troppopieno
Salvaspazio Desino: La Black Edition comprende il pomolo Advant (rivestimento con polvere, nero, opaco) nel prezzo e nel corredo di fornitura

Preis CHF/Prezzo in CHF

Modell Modello	Material Materiale	Ventil sFlow, Typ M Piletta sFlow, tipo M	Artikel-Nr. N. di articolo	Beckentiefe Profondità	Exkl. MWST IVA esclusa	Inkl. MWST IVA inclusa	VRG TAR
LIO CDAB 50U Black Edition Ausführung für 60-er Unterschrank / LIO CDAB 50U Black Edition versione per una base di 60 cm							
Linero LIO CDAB 50U/1 Black Edition	Cristadur, Puro	3 1/2" TouchFlow Desino	10.105.282.50 	165 mm	B	1739.–	1880.–
		3 1/2" Raumspar Desino Salvaspazio Desino	10.105.283.50 	165 mm	B	1529.–	1653.–
LIO CDAB 50U Black Edition Ausführung für 55-er Unterschrank / LIO CDAB 50U Black Edition versione per una base di 55 cm							
Linero LIO CDAB 50U/2 Black Edition	Cristadur, Puro	3 1/2" TouchFlow Desino	10.105.310.50 	165 mm	B	1806.–	1952.–
		3 1/2" Raumspar Desino Salvaspazio Desino	10.105.311.50 	165 mm	B	1596.–	1725.–

Linero LIO CDAB 50U/2 Black Edition für 55-er Unterschrank
Linero LIO CDAB 50U/2 Black Edition per una base di 55 cm



Erfordert beidseitigen Ausschnitt der Korpuswand.
Richiede un intaglio della parete dell'armadio su entrambi i lati.

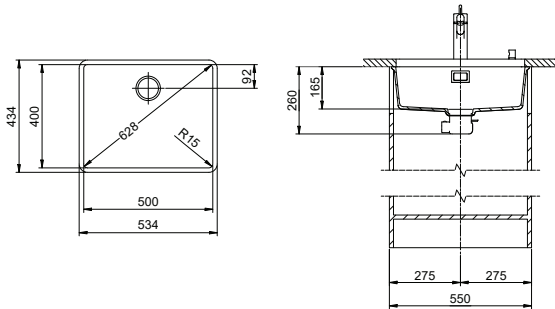

Zeichnung als pdf/dxf und Montageanleitung siehe:
V. disegno in formato pdf/dxf e montaggio:
suter.ch

Daneo: DAN CP 45U

SCHOCK
CRISTALITE®

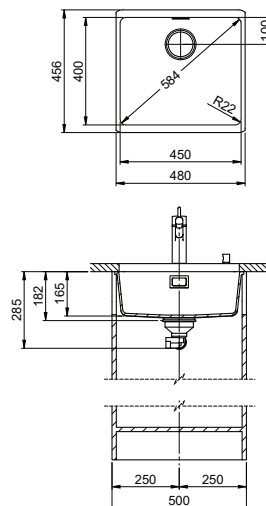

Schwenkbare Überlaufkappe
Placchetta di troppopieno a ribalta

27

Obenliegendes Sieb
Griglietta superiore

26



Zeichnung als pdf/dxf und Montageanleitung siehe:
V. disegno in formato pdf/dxf e montaggio:
suter.ch

Optionales Zubehör / Accessori opzionali

310

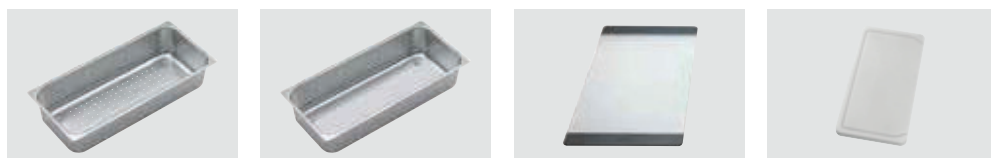

Resteschale gelocht
Vaschetta forato
CHF 106.– 40.000.912.00

Resteschale ungelocht
Vaschetta non forato
CHF 106.– 40.001.289.00

Schneidebrett aus Glas
Tagliere in vetro
CHF 151.– 40.000.909.00

Schneidebrett aus Kunststoff
Tagliere sintetico
CHF 151.– 40.001.277.00

Erfordert beidseitigen Ausschnitt der Korpuswand.
Richiede un taglio della parete dell'armadio su entrambi i lati.

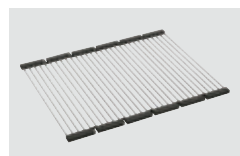

Inox Pad
CHF 125.– 40.001.138.00



Reinigungsset Easy Care
Kit di pulizia Easy Care
CHF 43.–/F 40.001.509.00

Mehrprijs für beschichtete Ventilbestandteile
TouchFlow und Raumspar: Stössel, Ventilkelch, Siebeinsatz, Überlaufblende und Überlaufkappe
Tipo: Tipo-Siebstopfen, Ventilkelch, Überlaufblende und Überlaufkappe
Sovraprezzo per componenti piletta color nero con rivestimento
TouchFlow e salvaspazio: Saltarello, tazza, griglietta, mascherina e tappo di troppopieno
Tipo: Tipo a tappo c. griglietta, tazza, mascherina e tappo di troppopieno



PVD-Beschichtung, Graphit
Rivestimento a PVD, grafite
3 1/2" TouchFlow
CHF 169.–/F 40.002.562.02

PVD-Beschichtung, Graphit
Rivestimento a PVD, grafite
3 1/2" Raumspar / Salvaspazio
CHF 169.–/F 40.002.563.02

PVD-Beschichtung, Graphit
Rivestimento a PVD, grafite
3 1/2" Tipo
CHF 169.–/F 40.002.564.02

DEC-Beschichtung, schwarz matt
Rivestimento a DEC, nero opaco
3 1/2" TouchFlow
CHF 197.–/F 40.002.559.02

DEC-Beschichtung, schwarz matt
Rivestimento a DEC, nero opaco
3 1/2" Raumspar / Salvaspazio
CHF 197.–/F 40.002.560.02

DEC-Beschichtung, schwarz matt
Rivestimento a DEC, nero opaco
3 1/2" Tipo
CHF 197.–/F 40.002.561.02



Varianten: Für die flächenbündige Spüle Daneo mit Standard Zugknopf Advant Chrom bestellen Sie

xx.xxx.xx.01 Standardartikel ohne Zugknopf. Reduktion CHF 24.–. Im Austausch wählen Sie den gewünschten Zugknopf auf Seite 358.
 xx.xxx.xx.02 Standardartikel ohne Ventilbestandteile und Überlaufkappe in Edelstahl. Im Austausch wählen Sie die Bestandteile in der Beckenfarbe auf Seite 196.
 xx.xxx.xx.03 Standardartikel ohne Zugknopf, Ventilbestandteile und Überlaufkappe in Edelstahl. Reduktion CHF 24.–. Im Austausch wählen Sie den gewünschten Zugknopf und die Bestandteile in der Beckenfarbe auf Seite 358.

Varianti: per il lavello sottopiano Daneo con pomolo standard Advant cromato, ordinate

xx.xxx.xx.01 – Articolo standard senza pomolo. Riduzione di CHF 24.–. In sostituzione, scegliete il pomolo desiderato a pagina 358.
 xx.xxx.xx.02 – Articolo standard senza componenti piletta e tappo per troppopieno in acciaio inox. In sostituzione, scegliete i componenti nel colore del lavello a pagina 196.
 xx.xxx.xx.03 – Articolo standard senza pomolo, componenti piletta e tappo per troppopieno in acciaio inox. Riduzione di CHF 24.–. In sostituzione, scegliete il pomolo desiderato e i componenti nel colore del lavello a pagina 358.

Preis CHF/Prezzo in CHF

Modell Modello	Material Materiale	Ventil Piletta	Artikel-Nr. N. di articolo	Beckentiefe Profondità	Exkl. MWST IVA esclusa	Inkl. MWST IVA inclusa	VRG TAR	
Daneo DAN CP 45U	Cristalite Plus, Nero	3 1/2" TouchFlow	10.104.734.00	165 mm	B	1222.–	1321.–	0.19
		3 1/2" Raumspar Salvaspazio	10.104.735.00	165 mm	B	1024.–	1107.–	
		3 1/2" Tipo	10.104.736.00	165 mm	B	983.–	1063.–	
	Cristalite Plus, Asphalt	3 1/2" TouchFlow	10.104.749.00	165 mm	B	1222.–	1321.–	0.19
		3 1/2" Raumspar Salvaspazio	10.104.750.00	165 mm	B	1024.–	1107.–	
		3 1/2" Tipo	10.104.751.00	165 mm	B	983.–	1063.–	
	Cristalite Plus, Mocha	3 1/2" TouchFlow	10.104.743.00	165 mm	B	1222.–	1321.–	0.19
		3 1/2" Raumspar Salvaspazio	10.104.744.00	165 mm	B	1024.–	1107.–	
		3 1/2" Tipo	10.104.745.00	165 mm	B	983.–	1063.–	
	Cristalite Plus, Croma	3 1/2" TouchFlow	10.104.740.00	165 mm	B	1222.–	1321.–	0.19
		3 1/2" Raumspar Salvaspazio	10.104.741.00	165 mm	B	1024.–	1107.–	
		3 1/2" Tipo	10.104.742.00	165 mm	B	983.–	1063.–	
	Cristalite Plus, Everest	3 1/2" TouchFlow	10.104.746.00	165 mm	B	1222.–	1321.–	0.19
		3 1/2" Raumspar Salvaspazio	10.104.747.00	165 mm	B	1024.–	1107.–	
		3 1/2" Tipo	10.104.748.00	165 mm	B	983.–	1063.–	
	Cristalite Plus, Alpina/Superwhite*	3 1/2" TouchFlow	10.104.737.00	165 mm	B	1222.–	1321.–	0.19
		3 1/2" Raumspar Salvaspazio	10.104.738.00	165 mm	B	1024.–	1107.–	
		3 1/2" Tipo	10.104.739.00	165 mm	B	983.–	1063.–	

* Änderung der Farbbezeichnung: 2024 ändert sich die Farbbezeichnung von Superwhite in Alpina. Der Farbton an sich bleibt unverändert.

* Modifica della denominazione del colore: nel 2024, la denominazione del colore cambia da Superwhite ad Alpina. La tonalità del colore rimane invariata.

Daneo: DAN CP 50U

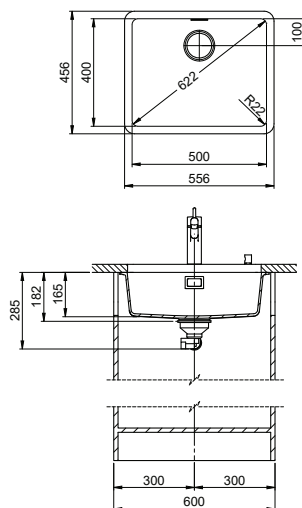
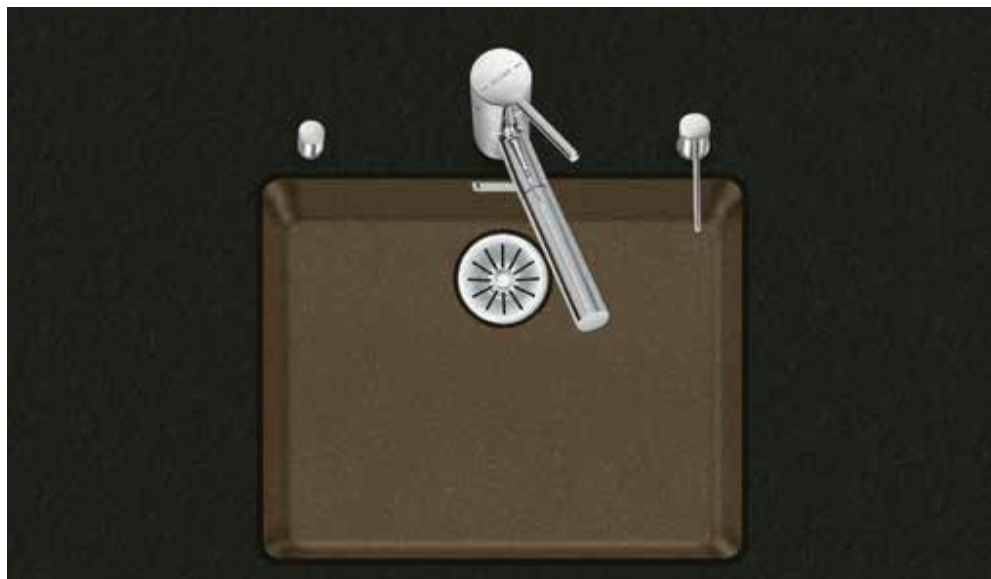

Schwenkbare Überlaufkappe
Placchetta di troppopieno a ribalta

27

Obenliegendes Sieb
Griglietta superiore

26



Zeichnung als pdf / dxf und Montageanleitung siehe:
V. disegno in formato pdf / dxf e montaggio:
suter.ch

Optionales Zubehör / Accessori opzionali

310

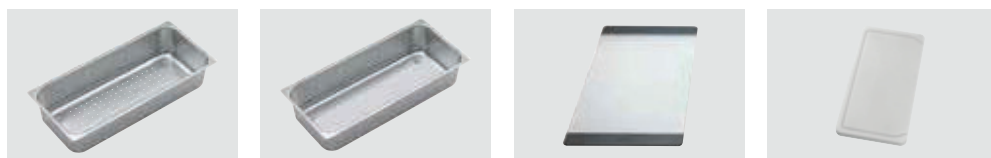

Resteschale gelocht
Vaschetta forata
CHF 106.– 40.000.912.00

Resteschale ungelocht
Vaschetta non forata
CHF 106.– 40.001.289.00

Schneidebrett aus Glas
Tagliere in vetro
CHF 151.– 40.000.909.00

Schneidebrett aus Kunststoff
Tagliere sintetico
CHF 151.– 40.001.277.00

Mehrprijs für beschichtete Ventilbestandteile
TouchFlow und Raumspar: Stössel, Ventilkelch, Siebeinsatz, Überlaufblende und Überlaufkappe
Tipe: Tipo-Siebstopfen, Ventilkelch, Überlaufblende und Überlaufkappe

Sovraprezzo per componenti piletta color nero con rivestimento
TouchFlow e salvaspazio: Saltarello, tazza, griglietta, mascherina e tappo di troppopieno
Tipe: Tipo a tappo c. griglietta, tazza, mascherina e tappo di troppopieno

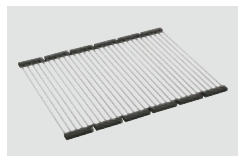

Innox Pad
CHF 125.– 40.001.138.00



Reinigungsset Easy Care
Kit di pulizia Easy Care
CHF 43.–/F 40.001.509.00

Varianten: Für die flächenbündige Spüle Daneo mit Standard Zugknopf Advant Chrom bestellen Sie
xx.xxx.xx.01 Standardartikel ohne Zugknopf. Reduktion CHF 24.–. Im Austausch wählen Sie den gewünschten Zugknopf auf Seite 358.
xx.xxx.xx.02 Standardartikel ohne Ventilbestandteile und Überlaufkappe in Edelstahl. Im Austausch wählen Sie die Bestandteile in der Beckenfarbe auf Seite 198.
xx.xxx.xx.03 Standardartikel ohne Zugknopf, Ventilbestandteile und Überlaufkappe in Edelstahl. Reduktion CHF 24.–. Im Austausch wählen Sie den gewünschten Zugknopf und die Bestandteile in der Beckenfarbe auf Seite 358.

Varianten: per il lavello sottopiano Daneo con pomolo standard Advant cromato, ordinate
xx.xxx.xx.01 – Articolo standard senza pomolo. Riduzione di CHF 24.–. In sostituzione, scegliete il pomolo desiderato a pagina 358.
xx.xxx.xx.02 – Articolo standard senza componenti piletta e tappo per troppopieno in acciaio inox. In sostituzione, scegliete i componenti nel colore del lavello a pagina 198.
xx.xxx.xx.03 – Articolo standard senza pomolo, componenti piletta e tappo per troppopieno in acciaio inox. Riduzione di CHF 24.–. In sostituzione, scegliete il pomolo desiderato e i componenti nel colore del lavello a pagina 358.



PVD-Beschichtung, Graphit
Rivestimento a PVD, grafite
3 1/2" TouchFlow
CHF 169.–/F 40.002.562.02

PVD-Beschichtung, Graphit
Rivestimento a PVD, grafite
3 1/2" Raumspar / Salvaspazio
CHF 169.–/F 40.002.563.02

PVD-Beschichtung, Graphit
Rivestimento a PVD, grafite
3 1/2" Tipe
CHF 169.–/F 40.002.564.02

DEC-Beschichtung, schwarz matt
Rivestimento a DEC, nero opaco
3 1/2" TouchFlow
CHF 197.–/F 40.002.559.02

DEC-Beschichtung, schwarz matt
Rivestimento a DEC, nero opaco
3 1/2" Raumspar / Salvaspazio
CHF 197.–/F 40.002.560.02

DEC-Beschichtung, schwarz matt
Rivestimento a DEC, nero opaco
3 1/2" Tipe
CHF 197.–/F 40.002.561.02

Preis CHF/Prezzo in CHF

Modell Modello	Material Materiale	Ventil Piletta	Artikel-Nr. N. di articolo	Beckentiefe Profondità	Exkl. MWST IVA esclusa	Inkl. MWST IVA inclusa	VRG TAR	
Daneo DAN CP 50U/1	Cristalite Plus, Nero	3 1/2" TouchFlow	10.104.752.00	165 mm	B	1278.–	1382.–	0.19
		3 1/2" Raumspar Salvaspazio	10.104.753.00	165 mm	B	1080.–	1167.–	
		3 1/2" Tipo	10.104.754.00	165 mm	B	1039.–	1123.–	
	Cristalite Plus, Asphalt	3 1/2" TouchFlow	10.104.767.00	165 mm	B	1278.–	1382.–	0.19
		3 1/2" Raumspar Salvaspazio	10.104.768.00	165 mm	B	1080.–	1167.–	
		3 1/2" Tipo	10.104.769.00	165 mm	B	1039.–	1123.–	
	Cristalite Plus, Mocha	3 1/2" TouchFlow	10.104.761.00	165 mm	B	1278.–	1382.–	0.19
		3 1/2" Raumspar Salvaspazio	10.104.762.00	165 mm	B	1080.–	1167.–	
		3 1/2" Tipo	10.104.763.00	165 mm	B	1039.–	1123.–	
	Cristalite Plus, Croma	3 1/2" TouchFlow	10.104.758.00	165 mm	B	1278.–	1382.–	0.19
		3 1/2" Raumspar Salvaspazio	10.103.759.00	165 mm	B	1080.–	1167.–	
		3 1/2" Tipo	10.103.760.00	165 mm	B	1039.–	1123.–	
	Cristalite Plus, Everest	3 1/2" TouchFlow	10.104.764.00	165 mm	B	1278.–	1382.–	0.19
		3 1/2" Raumspar Salvaspazio	10.103.765.00	165 mm	B	1080.–	1167.–	
		3 1/2" Tipo	10.103.766.00	165 mm	B	1039.–	1123.–	
	Cristalite Plus, Alpina/Superwhite*	3 1/2" TouchFlow	10.104.755.00	165 mm	B	1278.–	1382.–	0.19
		3 1/2" Raumspar Salvaspazio	10.104.756.00	165 mm	B	1080.–	1167.–	
		3 1/2" Tipo	10.104.757.00	165 mm	B	1039.–	1123.–	

DAN CP 50U Ausführung für 55-er Unterschränk / DAN CP 50U versione per una base di 55 cm

Daneo DAN CP 50U/2	Cristalite Plus, Nero	3 1/2" TouchFlow	10.104.770.00	165 mm	B	1332.–	1440.–	0.19
		3 1/2" Raumspar Salvaspazio	10.104.771.00	165 mm	B	1134.–	1226.–	
		3 1/2" Tipo	10.104.772.00	165 mm	B	1093.–	1182.–	
	Cristalite Plus, Asphalt	3 1/2" TouchFlow	10.104.785.00	165 mm	B	1332.–	1440.–	0.19
		3 1/2" Raumspar Salvaspazio	10.104.786.00	165 mm	B	1134.–	1226.–	
		3 1/2" Tipo	10.104.787.00	165 mm	B	1093.–	1182.–	
	Cristalite Plus, Mocha	3 1/2" TouchFlow	10.104.779.00	165 mm	B	1332.–	1440.–	0.19
		3 1/2" Raumspar Salvaspazio	10.104.780.00	165 mm	B	1134.–	1226.–	
		3 1/2" Tipo	10.104.781.00	165 mm	B	1093.–	1182.–	
	Cristalite Plus, Croma	3 1/2" TouchFlow	10.104.776.00	165 mm	B	1332.–	1440.–	0.19
		3 1/2" Raumspar Salvaspazio	10.104.777.00	165 mm	B	1134.–	1226.–	
		3 1/2" Tipo	10.104.778.00	165 mm	B	1093.–	1182.–	
	Cristalite Plus, Everest	3 1/2" TouchFlow	10.104.782.00	165 mm	B	1332.–	1440.–	0.19
		3 1/2" Raumspar Salvaspazio	10.104.783.00	165 mm	B	1134.–	1226.–	
		3 1/2" Tipo	10.104.784.00	165 mm	B	1093.–	1182.–	
	Cristalite Plus, Alpina/Superwhite*	3 1/2" TouchFlow	10.104.773.00	165 mm	B	1332.–	1440.–	0.19
		3 1/2" Raumspar Salvaspazio	10.104.774.00	165 mm	B	1134.–	1226.–	
		3 1/2" Tipo	10.104.775.00	165 mm	B	1093.–	1182.–	

Daneo DAN CP 50U/2 für 55-er Unterschränk
Daneo DAN CP 50U/2 per una base di 55 cm

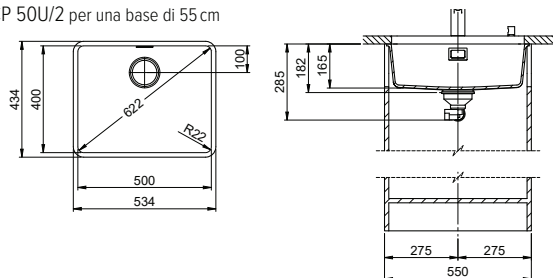

* Änderung der Farbbezeichnung: 2024 ändert sich die Farbbezeichnung von Superwhite in Alpina. Der Farbton an sich bleibt unverändert.

* Modifica della denominazione del colore: nel 2024, la denominazione del colore cambia da Superwhite ad Alpina. La tonalità del colore rimane invariata.



Erfordert beidseitigen Ausschnitt der Korpuswand.
Richiede un taglio della parete dell'armadio su entrambi i lati.

Zeichnung als pdf/dxf und Montageanleitung siehe:
V. disegno in formato pdf/dxf e montaggio:
suter.ch

Daneo: DAN CP 55U

SCHOCK
CRISTALITE®

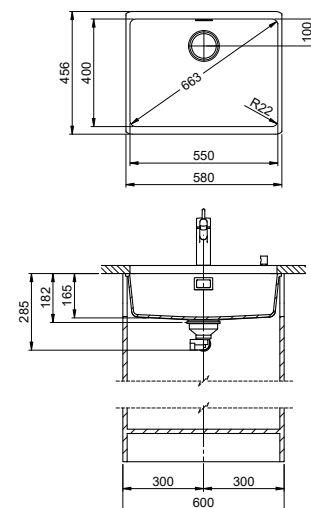
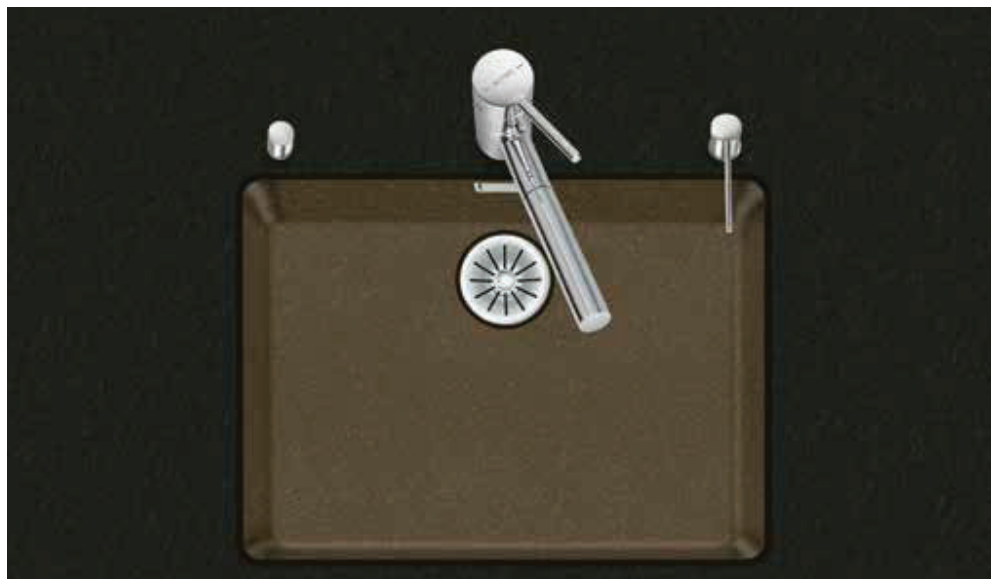

Schwenkbare Überlaufkappe
Placchetta di troppopieno a ribalta

27

Obenliegendes Sieb
Griglietta superiore

26



Zeichnung als pdf/dxf und Montageanleitung siehe:
V. disegno in formato pdf/dxf e montaggio:
suter.ch

Optionales Zubehör / Accessori opzionali

310

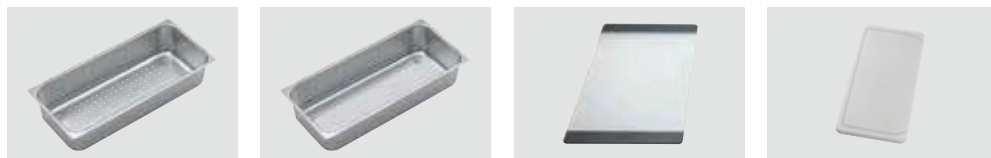

Resteschale gelocht
Vaschetta forata
CHF 106.- 40.000.912.00

Resteschale ungelocht
Vaschetta non forata
CHF 106.- 40.001.289.00

Schneidebrett aus Glas
Tagliere in vetro
CHF 151.- 40.000.909.00

Schneidebrett aus Kunststoff
Tagliere sintetico
CHF 151.- 40.001.277.00

Erfordert beidseitigen Ausschnitt der Korpuswand.
Richiede un taglio della parete dell'armadio su entrambi i lati.

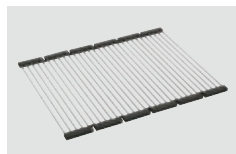

Inox Pad
CHF 125.- 40.001.138.00



Reinigungsset Easy Care
Kit di pulizia Easy Care
CHF 43.-/F 40.001.509.00

Mehrprijs für beschichtete Ventilbestandteile
TouchFlow und Raumspar: Stössel, Ventilkelch, Siebeinsatz, Überlaufblende und Überlaufkappe
Tipo: Tipo-Siebstopfen, Ventilkelch, Überlaufblende und Überlaufkappe

Sovrapprezzo per componenti piletta color nero con rivestimento

TouchFlow e salvaspazio: Saltarello, tazza, griglietta, mascherina e tappo di troppopieno
Tipo: Tipo a tappo c. griglietta, tazza, mascherina e tappo di troppopieno



PVD-Beschichtung, Graphit
Rivestimento a PVD, grafite
3 1/2" TouchFlow
CHF 169.-/F 40.002.562.02



PVD-Beschichtung, Graphit
Rivestimento a PVD, grafite
3 1/2" Raumspar / Salvaspazio
CHF 169.-/F 40.002.563.02



PVD-Beschichtung, Graphit
Rivestimento a PVD, grafite
3 1/2" Tipo
CHF 169.-/F 40.002.564.02



DEC-Beschichtung, schwarz matt
Rivestimento a DEC, nero opaco
3 1/2" TouchFlow
CHF 197.-/F 40.002.559.02



DEC-Beschichtung, schwarz matt
Rivestimento a DEC, nero opaco
3 1/2" Raumspar / Salvaspazio
CHF 197.-/F 40.002.560.02



DEC-Beschichtung, schwarz matt
Rivestimento a DEC, nero opaco
3 1/2" Tipo
CHF 197.-/F 40.002.561.02



Varianten: Für die flächenbündige Spüle Daneo mit Standard Zugknopf Advant Chrom bestellen Sie

xx.xxx.xx.01 Standardartikel ohne Zugknopf. Reduktion CHF 24.–. Im Austausch wählen Sie den gewünschten Zugknopf auf Seite 358.

xx.xxx.xx.02 Standardartikel ohne Ventilbestandteile und Überlaufkappe in Edelstahl. Im Austausch wählen Sie die Bestandteile in der Beckenfarbe auf Seite 200.

xx.xxx.xx.03 Standardartikel ohne Zugknopf, Ventilbestandteile und Überlaufkappe in Edelstahl. Reduktion CHF 24.–. Im Austausch wählen Sie den gewünschten Zugknopf und die Bestandteile in der Beckenfarbe auf Seite 358.

Varianti: per il lavello sottopiano Daneo con pomolo standard Advant cromato, ordinate

xx.xxx.xx.01 – Articolo standard senza pomolo. Riduzione di CHF 24.–. In sostituzione, scegliete il pomolo desiderato a pagina 358.

xx.xxx.xx.02 – Articolo standard senza componenti piletta e tappo per troppopieno in acciaio inox. In sostituzione, scegliete i componenti nel colore del lavello a pagina 200.

xx.xxx.xx.03 – Articolo standard senza pomolo, componenti piletta e tappo per troppopieno in acciaio inox. Riduzione di CHF 24.–. In sostituzione, scegliete il pomolo desiderato e i componenti nel colore del lavello a pagina 358.

Preis CHF/Prezzo in CHF

Modell Modello	Material Materiale	Ventil Piletta	Artikel-Nr. N. di articolo	Beckentiefe Profondità	Exkl. MWST IVA esclusa	Inkl. MWST IVA inclusa	VRG TAR	
Daneo DAN CP 55U	Cristalite Plus, Nero	3 ½" TouchFlow	10.104.788.00	165 mm	B	1439.–	1556.–	0,19
		3 ½" Raumsparsalvaspazio	10.104.789.00	165 mm	B	1241.–	1342.–	
		3 ½" Tipo	10.104.790.00	165 mm	B	1200.–	1297.–	
	Cristalite Plus, Asphalt	3 ½" TouchFlow	10.104.803.00	165 mm	B	1439.–	1556.–	0,19
		3 ½" Raumsparsalvaspazio	10.104.804.00	165 mm	B	1241.–	1342.–	
		3 ½" Tipo	10.104.805.00	165 mm	B	1200.–	1297.–	
	Cristalite Plus, Mocha	3 ½" TouchFlow	10.104.797.00	165 mm	B	1439.–	1556.–	0,19
		3 ½" Raumsparsalvaspazio	10.104.798.00	165 mm	B	1241.–	1342.–	
		3 ½" Tipo	10.104.799.00	165 mm	B	1200.–	1297.–	
	Cristalite Plus, Cromo	3 ½" TouchFlow	10.104.794.00	165 mm	B	1439.–	1556.–	0,19
		3 ½" Raumsparsalvaspazio	10.104.795.00	165 mm	B	1241.–	1342.–	
		3 ½" Tipo	10.104.796.00	165 mm	B	1200.–	1297.–	
	Cristalite Plus, Everest	3 ½" TouchFlow	10.104.800.00	165 mm	B	1439.–	1556.–	0,19
		3 ½" Raumsparsalvaspazio	10.104.801.00	165 mm	B	1241.–	1342.–	
		3 ½" Tipo	10.104.802.00	165 mm	B	1200.–	1297.–	
	Cristalite Plus, Alpina/Superwhite*	3 ½" TouchFlow	10.104.791.00	165 mm	B	1439.–	1556.–	0,19
		3 ½" Raumsparsalvaspazio	10.104.792.00	165 mm	B	1241.–	1342.–	
		3 ½" Tipo	10.104.793.00	165 mm	B	1200.–	1297.–	

* Änderung der Farbbezeichnung: 2024 ändert sich die Farbbezeichnung von Superwhite in Alpina. Der Farbton an sich bleibt unverändert.

* Modifica della denominazione del colore: nel 2024, la denominazione del colore cambia da Superwhite ad Alpina. La tonalità del colore rimane invariata.



Daneo: DAN CP 55U

Brooklyn: BYK N 100S U

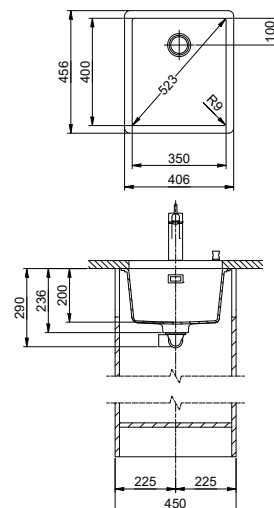
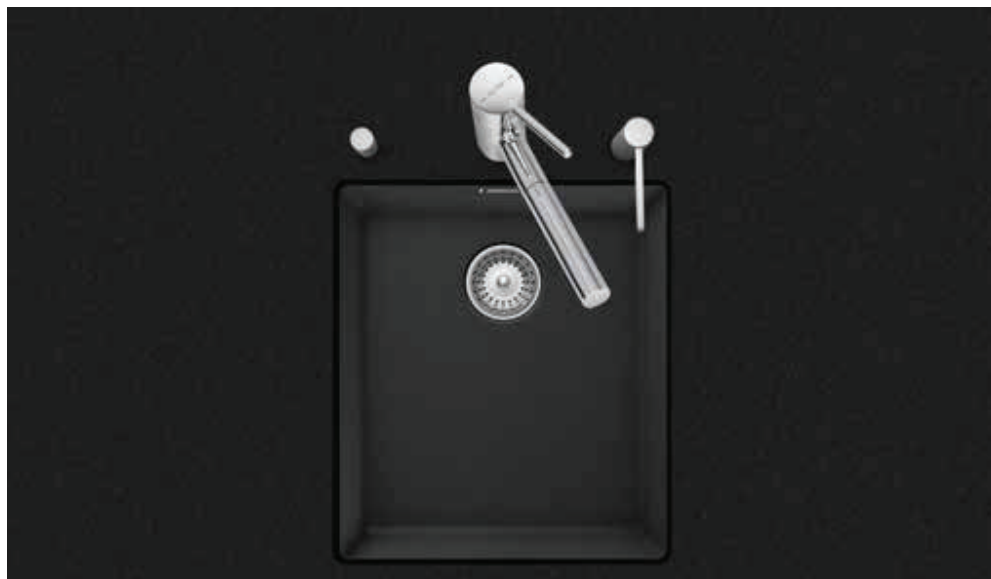
SCHOCK
 CRISTALITE®

Optionales Zubehör/Accessori opzionali

310

Resteschale gelocht
Vaschetta forato
 CHF 106.– 40.000.912.00

Resteschale ungelocht
Vaschetta non forato
 CHF 106.– 40.001.289.00

Schneidebrett aus Glas
Tagliere in vetro
 CHF 151.– 40.000.909.00

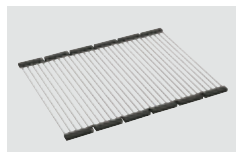
Schneidebrett aus Kunststoff
Tagliere sintetico
 CHF 151.– 40.001.277.00

Inox Pad
 CHF 125.– 40.001.138.00

Reinigungsset Easy Care
Kit di pulizia Easy Care
 CHF 43.–/F 40.001.509.00

 Zeichnung als pdf/dxf und Montageanleitung siehe:
 V. disegno in formato pdf/dxf e montaggio:
 suter.ch

Varianten: Für das Unterbau-Becken Brooklyn mit Standard Zugknopf Prime Chrom bestellen Sie

xx.xxx.xx.01 Standardartikel ohne Zugknopf. Reduktion CHF 24.–. Im Austausch wählen Sie den gewünschten Zugknopf auf Seite 358.

Varianti: per il lavello sottopiano Brooklyn con pomolo standard Prime cromato, ordinate

xx.xxx.xx.01 – Articolo standard senza pomolo. Riduzione di CHF 24.–. In sostituzione, scegliete il pomolo desiderato a pagina 358.

Preis CHF/Prezzo in CHF

Modell Modello	Material Materiale	Ventil Piletta	Artikel-Nr. N. di articolo	Beckentiefe Profondità	Exkl. MWST IVA esclusa	Inkl. MWST IVA inclusa
Brooklyn BYK N 100S U	Cristalite Plus, Nero	3 1/2" Raumspar Salvaspazio	10.104.321.00	200 mm	B 841.–	909.–
		3 1/2" Siebstopfen A tappo con griglietta	10.104.322.00	200 mm	B 800.–	865.–

Brooklyn: BYKAB N 100S U Black Edition

SCHOCK
CRISTALITE®

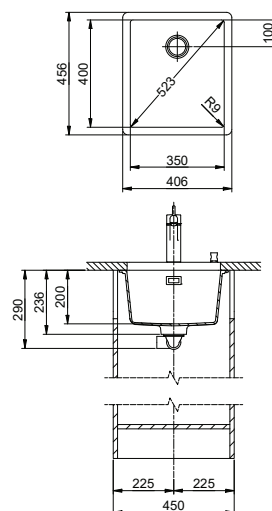

Optionales Zubehör / Accessori opzionali

310

			
Resteschale gelocht Vaschetta forato	Resteschale ungelocht Vaschetta non forato	Schneidebrett aus Glas Tagliere in vetro	Schneidebrett aus Kunststoff Tagliere sintetico
CHF 106.– 40.000.912.00	CHF 106.– 40.001.289.00	CHF 151.– 40.000.909.00	CHF 151.– 40.001.277.00
			
Inox Pad	Reinigungsset Easy Care Kit di pulizia Easy Care		
CHF 125.– 40.001.138.00	CHF 43.–/F 40.001.509.00		

Zeichnung als pdf / dxf und Montageanleitung siehe:
V. disegno in formato pdf / dxf e montaggio:
suter.ch

i Beschichtete Ventilbestandteile: im Preis und Lieferumfang inbegriffen
Siebstopfen: Überlaufblende und Überlaufklappe, Ventilkelch und Sieb
Raumspär: Überlaufblende und Überlaufklappe, Ventilkelch und Sieb, Zugknopf Prime in Kunststoff (schwarz matt)
Componenti piletta rivestiti: inclusi nel prezzo e nel corredo di fornitura
Tappi con griglietta: mascherina di troppopieno e tappo di troppopieno, tazza e griglietta
Salvaspazio: mascherina di troppopieno e tappo di troppopieno, tazza e griglietta, pomolo Prime in plastica (nero opaco)

Preis CHF / Prezzo in CHF

Modell Modello	Material Materiale	Ventil Piletta	Artikel-Nr. N. di articolo	Beckentiefe Profondità	Exkl. MWST IVA esclusa	Inkl. MWST IVA inclusa
Brooklyn BYKAB N 100S U Black Edition	Cristalite Plus, Nero	3 1/2" Raumspär Salvaspazio	10.105.320.00 	200 mm	B 881.–	952.–
		3 1/2" Siebstopfen A tappo con griglietta	10.105.321.00 	200 mm	B 840.–	908.–

Brooklyn: BYK N 100U

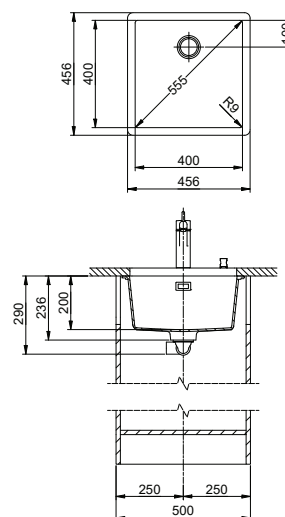
SCHOCK
 CRISTALITE®

Optionales Zubehör/Accessori opzionali

310

Resteschale gelocht
Vaschetta forato
 CHF 106.– 40.000.912.00

Resteschale ungelocht
Vaschetta non forato
 CHF 106.– 40.001.289.00

Schneidebrett aus Glas
Tagliere in vetro
 CHF 151.– 40.000.909.00

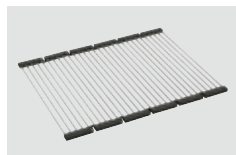
Schneidebrett aus Kunststoff
Tagliere sintetico
 CHF 151.– 40.001.277.00

Inox Pad
 CHF 125.– 40.001.138.00

Reinigungsset Easy Care
Kit di pulizia Easy Care
 CHF 43.–/F 40.001.509.00

 Zeichnung als pdf / dxf und Montageanleitung siehe:
 V. disegno in formato pdf / dxf e montaggio:
 suter.ch

Varianten: Für das Unterbau-Becken Brooklyn mit Standard Zugknopf Prime Chrom bestellen Sie

xx.xxx.xx.01 Standardartikel ohne Zugknopf. Reduktion CHF 24.–. Im Austausch wählen Sie den gewünschten Zugknopf auf Seite 358.

Varianti: per il lavello sottopiano Brooklyn con pomolo standard Prime cromato, ordinate

xx.xxx.xx.01 – Articolo standard senza pomolo. Riduzione di CHF 24.–. In sostituzione, scegliete il pomolo desiderato a pagina 358.

Preis CHF/Prezzo in CHF

Modell Modello	Material Materiale	Ventil Piletta	Artikel-Nr. N. di articolo	Beckentiefe Profondità	Exkl. MWST IVA esclusa	Inkl. MWST IVA inclusa
Brooklyn BYK N 100U	Cristalite Plus, Nero	3 1/2" Raumspar Salvaspazio	10.103.292.00	200 mm	B 878.–	949.–
		3 1/2" Siebstopfen A tappo con griglietta	10.104.319.00	200 mm	B 837.–	905.–

Brooklyn: BYKAB N 100U Black Edition

SCHOCK
CRISTALITE®

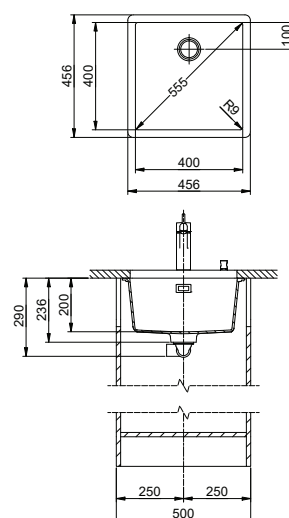

Optionales Zubehör / Accessori opzionali

310



Resteschale gelocht
Vaschetta forato
CHF 106.– 40.000.912.00



Resteschale ungelocht
Vaschetta non forato
CHF 106.– 40.001.289.00

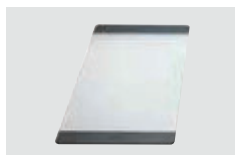

Schneidebrett aus Glas
Tagliere in vetro
CHF 151.– 40.000.909.00



Schneidebrett aus Kunststoff
Tagliere sintetico
CHF 151.– 40.001.277.00

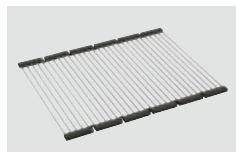

Inox Pad
CHF 125.– 40.001.138.00



Reinigungsset Easy Care
Kit di pulizia Easy Care
CHF 43.–/F 40.001.509.00

Zeichnung als pdf / dxf und Montageanleitung siehe:
V. disegno in formato pdf / dxf e montaggio:
suter.ch

**i Beschichtete Ventilbestandteile:
im Preis und Lieferumfang inbegriffen**

Siebstopfen: Überlaufblende und Überlaufklappe, Ventilkelch und Sieb

Raumspär: Überlaufblende und Überlaufklappe, Ventilkelch und Sieb, Zugknopf Prime in Kunststoff (schwarz matt)

Componenti piletta rivestiti: inclusi nel prezzo e nel corredo di fornitura

Tappi con griglietta: mascherina di troppopieno e tappo di troppopieno, tazza e griglietta

Salvaspazio: mascherina di troppopieno e tappo di troppopieno, tazza e griglietta, pomolo Prime in plastica (nero opaco)

Preis CHF / Prezzo in CHF

Modell Modello	Material Materiale	Ventil Piletta	Artikel-Nr. N. di articolo	Beckentiefe Profondità	Exkl. MWST IVA esclusa	Inkl. MWST IVA inclusa
Brooklyn BYKAB N 100 U Black Edition	Cristalite Plus, Nero	3 1/2" Raumspär Salvaspazio	10.105.322.00	200 mm	B 918.–	992.–
		3 1/2" Siebstopfen A tappo con griglietta	10.105.323.00	200 mm	B 877.–	948.–

Brooklyn: BYK N 100L U

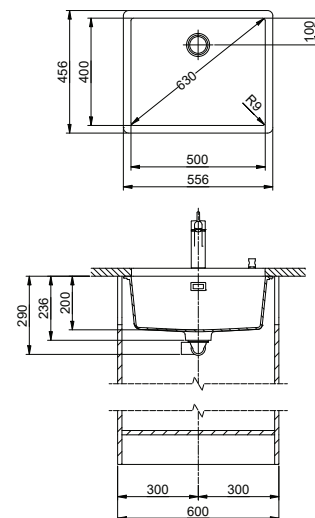
SCHOCK
 CRISTALITE®

Optionales Zubehör/Accessori opzionali

310

Resteschale gelocht
Vaschetta forato
 CHF 106.– 40.000.912.00

Resteschale ungelocht
Vaschetta non forato
 CHF 106.– 40.001.289.00

Schneidebrett aus Glas
Tagliere in vetro
 CHF 151.– 40.000.909.00

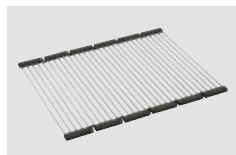
Schneidebrett aus Kunststoff
Tagliere sintetico
 CHF 151.– 40.001.277.00

Inox Pad
 CHF 125.– 40.001.138.00

Reinigungsset Easy Care
Kit di pulizia Easy Care
 CHF 43.–/F 40.001.509.00

 Zeichnung als pdf/dxf und Montageanleitung siehe:
 V. disegno in formato pdf/dxf e montaggio:
 suter.ch

Varianten: Für das Unterbau-Becken Brooklyn mit Standard Zugknopf Prime Chrom bestellen Sie

xx.xxx.xx.01 Standardartikel ohne Zugknopf. Reduktion CHF 24.–. Im Austausch wählen Sie den gewünschten Zugknopf auf Seite 358.

Varianti: per il lavello sottopiano Brooklyn con pomolo standard Prime cromato, ordinate

xx.xxx.xx.01 – Articolo standard senza pomolo. Riduzione di CHF 24.–. In sostituzione, scegliete il pomolo desiderato a pagina 358.

Preis CHF/Prezzo in CHF

Modell Modello	Material Materiale	Ventil Piletta	Artikel-Nr. N. di articolo	Beckentiefe Profondità	Exkl. MWST IVA esclusa	Inkl. MWST IVA inclusa
Brooklyn BYK N 100L U	Cristalite Plus, Nero	3 ½" Raumspar Salvaspazio	10.103.298.00	200 mm	B 924.–	999.–
		3 ½" Siebstopfen A tappo con griglietta	10.104.320.00	200 mm	B 883.–	955.–

Brooklyn: BYKAB N 100L U Black Edition

SCHOCK
CRISTALITE®

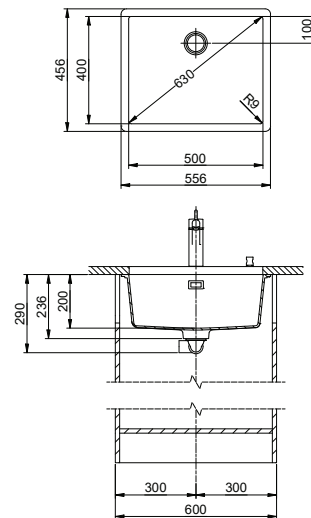

Optionales Zubehör/Accessori opzionali

310



Resteschale gelocht
Vaschetta forato
CHF 106.– 40.000.912.00



Resteschale ungelocht
Vaschetta non forato
CHF 106.– 40.001.289.00

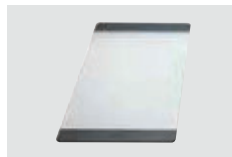

Schneidebrett aus Glas
Tagliere in vetro
CHF 151.– 40.000.909.00



Schneidebrett aus Kunststoff
Tagliere sintetico
CHF 151.– 40.001.277.00

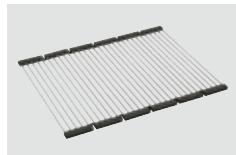

Inox Pad
CHF 125.– 40.001.138.00



Reinigungsset Easy Care
Kit di pulizia Easy Care
CHF 43.–/F 40.001.509.00

Zeichnung als pdf / dxf und Montageanleitung siehe:
V. disegno in formato pdf / dxf e montaggio:
suter.ch

**i Beschichtete Ventilbestandteile:
im Preis und Lieferumfang inbegriffen**

Siebstopfen: Überlaufblende und Überlaufklappe, Ventilkelch und Sieb

Raumspär: Überlaufblende und Überlaufklappe, Ventilkelch und Sieb, Zugknopf Prime in Kunststoff (schwarz matt)

Componenti piletta rivestiti: inclusi nel prezzo e nel corredo di fornitura

Tappi con griglietta: mascherina di troppopieno e tappo di troppopieno, tazza e griglietta

Salvaspazio: mascherina di troppopieno e tappo di troppopieno, tazza e griglietta, pomolo Prime in plastica (nero opaco)

Preis CHF/Prezzo in CHF

Modell Modello	Material Materiale	Ventil Piletta	Artikel-Nr. N. di articolo	Beckentiefe Profondità	Exkl. MWST IVA esclusa	Inkl. MWST IVA inclusa
Brooklyn BYKAB N 100L U Black Edition	Cristalite Plus, Nero	3 1/2" Raumspär Salvaspazio	10.105.324.00	200 mm	B 965.–	1043.–
		3 1/2" Siebstopfen A tappo con griglietta	10.105.325.00	200 mm	B 924.–	999.–

Quadro: QUA N 100

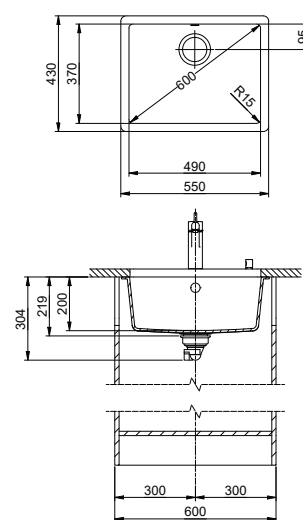
SCHOCK
 CRISTALITE®

Optionales Zubehör / Accessori opzionali

310

Reinigungsset Easy Care
Kit di pulizia Easy Care

CHF 43.–/F 40.001.509.00

 Zeichnung als pdf / dxf und Montageanleitung siehe:
 V. disegno in formato pdf / dxf e montaggio:
 suter.ch

Varianten: Für das Unterbau-Becken Quadro mit Standard Zugknopf Prime Chrom bestellen Sie

xx.xxx.xx.01 Standardartikel ohne Zugknopf. Reduktion CHF 24.–. Im Austausch wählen Sie den gewünschten Zugknopf auf Seite 358.

Varianti: per il lavello sottopiano Quadro con pomolo standard Prime cromato, ordinate

xx.xxx.xx.01 – Articolo standard senza pomolo. Riduzione di CHF 24.–. In sostituzione, scegliete il pomolo desiderato a pagina 358.

Preis CHF / Prezzo in CHF

Modell Modello	Material Materiale	Ventil Piletta	Artikel-Nr. N. di articolo	Beckentiefe Profondità	Exkl. MWST IVA esclusa	Inkl. MWST IVA inclusa
Quadro QUA N 100	Cristalite Plus, Nero	3 1/2" Raumspar Salvaspazio	10.103.006.00	200 mm	B 974.–	1053.–

Carbon: CAR N 100U

SCHOCK

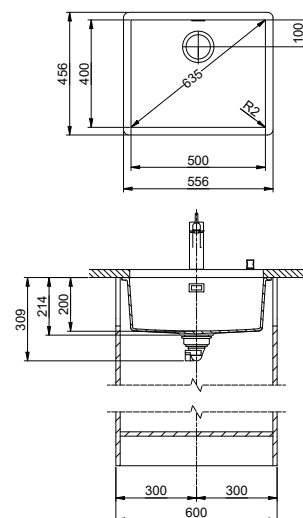

Optionales Zubehör/Accessori opzionali



Resteschale gelocht
Vaschetta forato
CHF 106.– 40.000.912.00



Resteschale ungelocht
Vaschetta non forato
CHF 106.– 40.001.289.00



Schneidebrett aus Glas
Tagliere in vetro
CHF 151.– 40.000.909.00



Schneidebrett aus Kunststoff
Tagliere sintetico
CHF 151.– 40.001.277.00

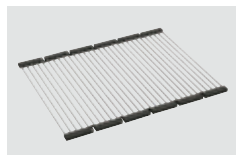

Inox Pad
CHF 125.– 40.001.138.00



Reinigungsset Easy Care
Kit di pulizia Easy Care
CHF 43.–/F 40.001.509.00

Zeichnung als pdf/dxf und Montageanleitung siehe:
V. disegno in formato pdf/dxf e montaggio:
suter.ch

! **Varianten: Für das Unterbau-Becken Carbon mit Standard Zugknopf Advant Chrom bestellen Sie**
xx.xxx.xx.01 Standardartikel ohne Zugknopf. Reduktion CHF 24.–. Im Austausch wählen Sie den gewünschten Zugknopf auf Seite 358.
Varianti: per il lavello sottopiano Carbon con pomolo standard Advant cromato, ordinate
xx.xxx.xx.01 – Articolo standard senza pomolo. Riduzione di CHF 24.–. In sostituzione, scegliete il pomolo desiderato a pagina 358.

Preis CHF/Prezzo in CHF

Modell Modello	Material Materiale	Ventil Piletta	Artikel-Nr. N. di articolo	Beckentiefe Profondità	Exkl. MWST IVA esclusa	Inkl. MWST IVA inclusa
Carbon CAR N 100U*	Carbon Carbonio 	3 1/2" Raumspar Salvaspazio	10.104.142.00	200 mm	F 2325.–	2513.–

* Lieferzeit auf Anfrage/Termine di consegna su richiesta



Sortiment nach Unterschrankmassen

Assortimento per dimensioni di base **212**

Edelstahl / Acciaio inox

Linero

LIO 18F/7	214
LIO 34F/7	215
LIO 40F/7	216
LIO 45F/7	217
LIO 50F/7	218
LIO 55F/7	219

Daneo

DAN 18IF/12	220 – 221
DAN 34F/7	222 – 223
DAN 34IF/12	224 – 225
DAN 40F/7	226 – 227
DAN 40IF/12	228 – 229
DAN 45F/7	230 – 231
DAN 45IF/12	232 – 233
DAN 50F/7	234 – 235
DAN 50IF/12	236 – 237
DAN 55F/7	238 – 239
DAN 55IF/12	240 – 241
DAN 100-50IF	242
DAN 100-50IF EL	243
DAN 100-55IF	244
DAN 110-50IF	245
DAN 110-55IF	246
DAN 40IF/A	247
DAN 50IF/A	248
DAN 55IF/A	249
DAN 100-50IF/A	250
DAN 100-50IF/A EL	251
DAN 100-55IF/A	252
DAN 110-50IF/A	253
DAN 110-55IF/A	254

Vantis

V 34IF/12	256 – 257
V 40IF/12	258 – 259
V 45IF/12	260 – 261
V 50-42IF/12	262 – 263
V 50-35IF/12	264 – 265
V 55IF/12	266 – 267
V 50IF/A	268
VX 34IF/15 Varix	269
VX 40IF/15 Varix	270
VX 45IF/15 Varix	271
VX 50-42IF/15 Varix	272
VX 55IF/15 Varix	273

Silver Star

SIL 45IF/12	274
SIS 50IF/12	275
SIL 55IF/12	276

Accento

A 65IF/12	277
-----------	------------

Granit (Cristadur)

Granito (Cristadur)

Linero

LIO CD 50F/17	278
LIO CDAB 50F/17 Black Edition	280

Granit (Cristalite Plus)

Granito (Cristalite Plus)

Daneo

DAN CP 45F/17	282
DAN CP 50F/17	284
DAN CP 55F/17	286

Montagematerial / Materiale per il montaggio



























Befestigungsklammern
für Flächenbündige- und Flachrand-Becken
Staffe di fissaggio
per lavelli a filo top e lavelli sopra piano
40.002.041.00





Befestigungsklammern
für Flächenbündige- und Flachrand-Spülen
Staffe di fissaggio
per lavelli a filo top e lavelli sopra piano
40.001.009.00

Sortiment nach Unterschrankmassen / Assortimento per dimensioni di base

	35cm	40cm	45cm	50cm
Linero sFlow, Typ M sFlow, tipo M	 <small>new</small> Linero: LIO 18F/7* <small>214</small>	 <small>new</small> Linero: LIO 34F/7* <small>215</small>	 <small>new</small> Linero: LIO 40F/7* <small>216</small>	 <small>new</small> Linero: LIO 45F/7* <small>217</small>
Daneo sFlow, Typ S sFlow, tipo S	 Daneo: DAN 18IF/12 <small>220</small>	 Daneo: DAN 34F/7* <small>222</small> Daneo: DAN 34IF/12 <small>224</small>	 Daneo: DAN 40F/7* <small>226</small> Daneo: DAN 40IF/12 <small>228</small>	 Daneo: DAN 45F/7* <small>230</small> Daneo: DAN 45IF/12 <small>232</small>
Daneo sFlow, Typ M sFlow, tipo M	 Daneo: DAN 18IF/12 <small>221</small>	 Daneo: DAN 34F/7* <small>223</small> Daneo: DAN 34IF/12 <small>225</small>	 Daneo: DAN 40F/7* <small>227</small> Daneo: DAN 40IF/12 <small>229</small>	 Daneo: DAN 45F/7* <small>231</small> Daneo: DAN 45IF/12 <small>233</small>
Daneo			 Daneo: DAN 40IF/A <small>247</small>	
Vantis sFlow, Typ S sFlow, tipo S		 Vantis: V 34IF/12 <small>256</small>	 Vantis: V 40IF/12 <small>258</small>	 Vantis: V 45IF/12 <small>260</small>
Vantis sFlow, Typ M sFlow, tipo M		 <small>new</small> Vantis: V 34IF/12 <small>257</small>	 <small>new</small> Vantis: V 40IF/12 <small>259</small>	 <small>new</small> Vantis: V 45IF/12 <small>261</small>
Silver Star / Accento		 <small>new</small> Vantis: VX 34IF/15 Varix <small>265</small>	 <small>new</small> Vantis: VX 40IF/15 Varix <small>270</small>	 Vantis: VX 45IF/15 Varix <small>271</small>
				 Silver Star: SIL 45IF/12 <small>274</small>

 eFlow mit eControl
eFlow con eControl

 Schwenkbare Überlaufkappe
Placchetta di troppopieno a ribalta

 Desino: Verdeckter Ablauf mit untenliegendem Sieb
Desino: Scarico coperto con griglietta inferiore

*Nur für flächenbündigen Einbau erhältlich
*Disponibili solo per montaggio a filo top

55cm



Linero: LIO 50F/7* 



Linero: LIO CD 50F/17* 



Linero: LIO CDAB 50F/17* 



Daneo: DAN 50F/7* 



Daneo: DAN 50IF/12



Daneo: DAN 50IF/A



Daneo: DAN 100-50IF EL



Daneo: DAN 100-50IF/A EL



Daneo: DAN 110-50IF



Daneo: DAN 110-50IF/A



Daneo: DAN CP 50F/17* 



Vantis: V 50-42IF/12



Vantis: V 50-35IF/12



Vantis: V 50-42IF/12 



Vantis: V 50-35IF/12 



Vantis: VX 50-42IF/15 Varix



Silver Star: SIS 50IF/12

60cm



Linero: LIO 55F/7* 



Daneo: DAN 55F/7* 



Daneo: DAN 55IF/12



Daneo: DAN 55IF/A



Daneo: DAN 100-55IF



Daneo: DAN 110-55IF



Daneo: DAN CP 55F/17* 



Vantis: V 50IF/A

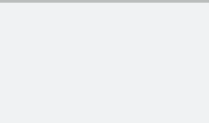



Vantis: VX 55IF/15 Varix

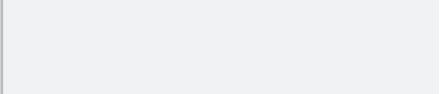
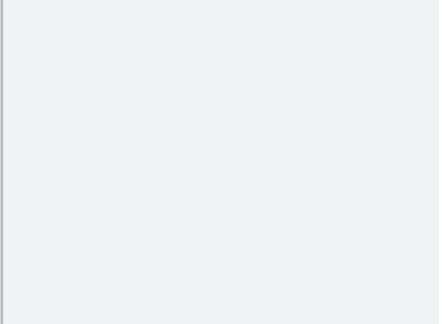
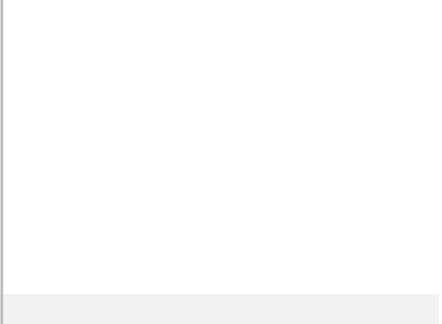
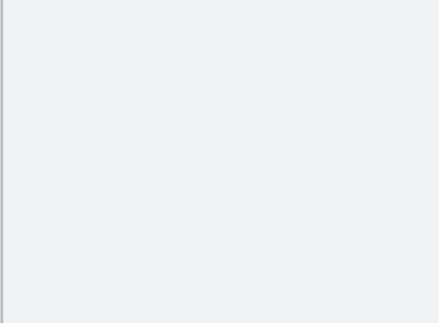

Silver Star: SIL 55IF/12

80cm



Accento: A 65IF/12 

Linero: LIO 18F/7

Randbreite 7 mm
Larghezza bordo 7 mm

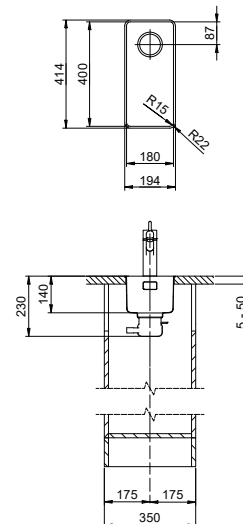
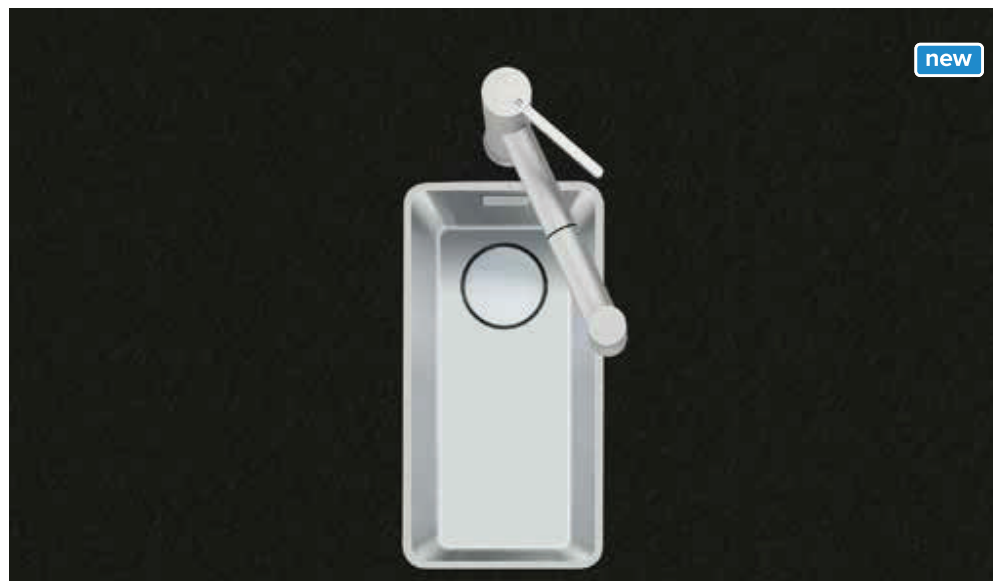

eFlow mit eControl
eFlow con eControl

Schwenkbare Überlaufkappe
Placchetta di troppopieno a ribalta

Desino: Verdeckter Ablauf mit untenliegendem Sieb
Desino: Scarico coperto con griglietta inferiore



Für eFlow Desino
Per eFlow Desino



Für TouchFlow Desino
Per TouchFlow Desino



Für eFlow Desino und TouchFlow Desino
Per eFlow Desino e TouchFlow Desino



Optionales Zubehör / Accessori opzionali

310



Resteschale gelocht
Vaschetta forato
CHF 106.- 40.000.912.00



Resteschale ungelocht
Vaschetta non forato
CHF 106.- 40.001.289.00



Schneidebrett aus Kunststoff
Tagliere sintetico
CHF 151.- 40.001.277.00

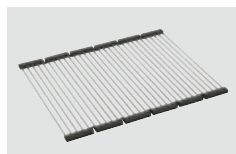

Inox Pad
CHF 125.- 40.001.138.00

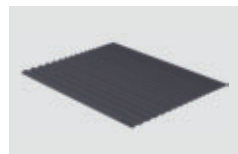

Maro Abtropfmatte aus Silikon
Maro tappetino scolapiatti in silicone
CHF 51.- 40.002.008.00

Zeichnung als pdf / dxf und Montageanleitung siehe:
V. disegno in formato pdf / dxf e montaggio:
suter.ch

Nur für flächenbündigen Einbau erhältlich.
Disponibile solo per montaggio a filo top.

Flächenbündiger Einbau: Empfehlung zur Wahl der Arbeitsplatte

Wir empfehlen den Einbau in Arbeitsplatten aus Keramik, Granit, Kunststein (z.B. Corian oder Varicor) oder Massivholz. Vom Einbau in beschichtete Spanplatten raten wir ab.

Montaggio a filo top: Consiglio per la scelta del piano di lavoro

Consigliamo il montaggio nei piani di lavoro in ceramica, granito, pietra artificiale (per es. Corian o Varicor) oppure in legno massiccio. Sconsigliamo la posa in pannelli di truciolato rivestiti.

Preis CHF / Prezzo in CHF

Modell Modello	Material Materiale		Ventil sFlow, Typ M Piletta sFlow, tipo M	Artikel-Nr. N. di articolo	Beckentiefe Profondità	Exkl. MWST IVA esclusa	Inkl. MWST IVA inclusa	VRG TRA
Linero LIO 18/F7	Edelstahl, matt Acciaio inox, opaco	18/10	3 1/2" eFlow Desino	10.105.233.00	140 mm	A 1455.-	1573.-	0.19
			3 1/2" TouchFlow Desino	10.105.234.00	140 mm	A 1340.-	1449.-	0.19

Linero: LIO 34F/7

Randbreite 7 mm
Larghezza bordo 7 mm

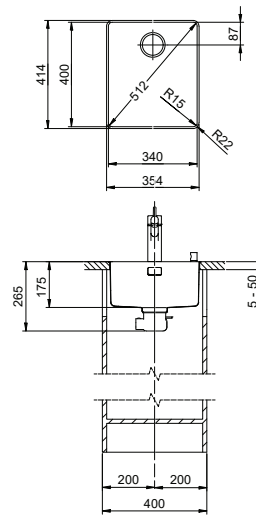

eFlow mit eControl
eFlow con eControl

Schwenkbare Überlaufkappe
Placchetta di troppopieno a ribalta

Desino: Verdeckter Ablauf mit untenliegendem Sieb
Desino: Scarico coperto con griglietta inferiore



Für eFlow Desino
Per eFlow Desino

Für TouchFlow Desino und Raumspär Desino
Per TouchFlow Desino e Salvaspazio Desino

Für eFlow Desino, TouchFlow Desino und Raumspär Desino
Per eFlow Desino, TouchFlow Desino e Salvaspazio Desino

Optionales Zubehör / Accessori opzionali

310



Resteschale gelocht
Vaschetta forato
CHF 106.– 40.000.912.00



Resteschale ungelocht
Vaschetta non forato
CHF 106.– 40.001.289.00



Schneidebrett aus Glas
Tagliere in vetro
CHF 151.– 40.000.909.00



Schneidebrett aus Kunststoff
Tagliere sintetico
CHF 151.– 40.001.277.00

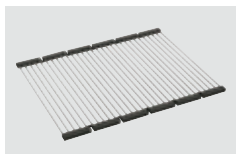

Inox Pad
CHF 125.– 40.001.138.00

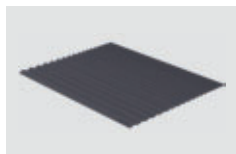

Maro Abtropfmatte aus Silikon
Maro tappetino scolapiatti in silicone
CHF 51.– 40.002.008.00

Zeichnung als pdf / dxf und Montageanleitung siehe:
V. disegno in formato pdf / dxf e montaggio:
suter.ch

Nur für flächenbündigen Einbau erhältlich.
Disponibile solo per montaggio a filo top.

Flächenbündiger Einbau: Empfehlung zur Wahl der Arbeitsplatte

Wir empfehlen den Einbau in Arbeitsplatten aus Keramik, Granit, Kunststoff (z.B. Corian oder Varicor) oder Massivholz. Vom Einbau in beschichtete Spanplatten raten wir ab.

Montaggio a filo top: Consiglio per la scelta del piano di lavoro

Consigliamo il montaggio nei piani di lavoro in ceramica, granito, pietra artificiale (per es. Corian o Varicor) oppure in legno massiccio. Sconsigliamo la posa in pannelli di truciolato rivestiti.

Preis CHF / Prezzo in CHF

Modell Modello	Material Materiale	Ventil sFlow, Typ M Piletta sFlow, tipo M	Artikel-Nr. N. di articolo	Beckentiefe Profondità	Exkl. MWST IVA esclusa	Inkl. MWST IVA inclusa	VRG TRA
Linero LIO 34F/7	Edelstahl, matt Acciaio inox, opaco	18 / 10	3 1/2" eFlow Desino	10.105.235.00	175 mm	A 1772.–	1916.– 0.19
			3 1/2" TouchFlow Desino	10.105.236.00	175 mm	A 1657.–	1791.– 0.19
			3 1/2" Raumspär Desino Salvaspazio Desino	10.105.237.00	175 mm	A 1447.–	1564.–

Linero: LIO 40F/7

Randbreite 7 mm
Larghezza bordo 7 mm

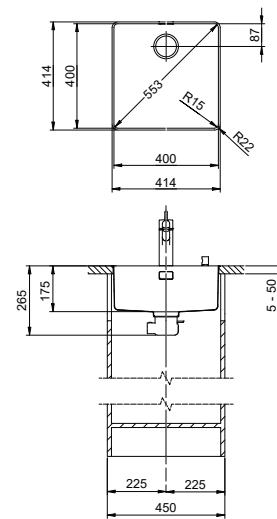

eFlow mit eControl
eFlow con eControl

Schwenkbare Überlaufkappe
Placchetta di troppopieno a ribalta

Desino: Verdeckter Ablauf mit untenliegendem Sieb
Desino: Scarico coperto con griglietta inferiore



Für eFlow Desino
Per eFlow Desino

Für TouchFlow Desino und Raumspär Desino
Per TouchFlow Desino e Salvaspazio Desino



Für eFlow Desino, TouchFlow Desino und Raumspär Desino
Per eFlow Desino, TouchFlow Desino e Salvaspazio Desino

Optionales Zubehör / Accessori opzionali

310



Resteschale gelocht
Vaschetta forato
CHF 106.– 40.000.912.00



Resteschale ungelocht
Vaschetta non forato
CHF 106.– 40.001.289.00

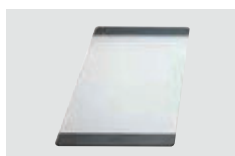

Schneidebrett aus Glas
Tagliere in vetro
CHF 151.– 40.000.909.00



Schneidebrett aus Kunststoff
Tagliere sintetico
CHF 151.– 40.001.277.00

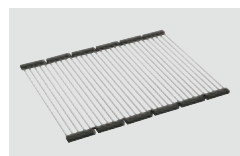

Inox Pad
CHF 125.– 40.001.138.00

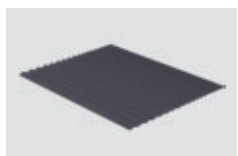

Maro Abtropfmatte aus Silikon
Maro tappetino scolapiatti in silicone
CHF 51.– 40.002.008.00

Zeichnung als pdf / dxf und Montageanleitung siehe:
V. disegno in formato pdf / dxf e montaggio:
suter.ch

Nur für flächenbündigen Einbau erhältlich.
Disponibile solo per montaggio a filo top.

Flächenbündiger Einbau: Empfehlung zur Wahl der Arbeitsplatte

Wir empfehlen den Einbau in Arbeitsplatten aus Keramik, Granit, Kunststein (z.B. Corian oder Varicor) oder Massivholz. Vom Einbau in beschichtete Spanplatten raten wir ab.

Montaggio a filo top: Consiglio per la scelta del piano di lavoro

Consigliamo il montaggio nei piani di lavoro in ceramica, granito, pietra artificiale (per es. Corian o Varicor) oppure in legno massiccio. Sconsigliamo la posa in pannelli di truciolato rivestiti.

Preis CHF/Prezzo in CHF

Modell Modello	Material Materiale	Ventil sFlow, Typ M Piletta sFlow, tipo M	Artikel-Nr. N. di articolo	Beckentiefe Profondità	Exkl. MWST IVA esclusa	Inkl. MWST IVA inclusa	VRG TRA
Linero LIO 40F/7	Edelstahl, matt Acciaio inox, opaco	18/10	3 1/2" eFlow Desino	10.105.238.00	175 mm	A 1847.–	1997.– 0.19
		3 1/2" TouchFlow Desino	10.105.239.00	175 mm	A 1732.–	1872.– 0.19	
		3 1/2" Raumspär Desino Salvaspazio Desino	10.105.240.00	175 mm	A 1522.–	1645.–	

Linero: LIO 45F/7

Randbreite 7 mm
Larghezza bordo 7 mm

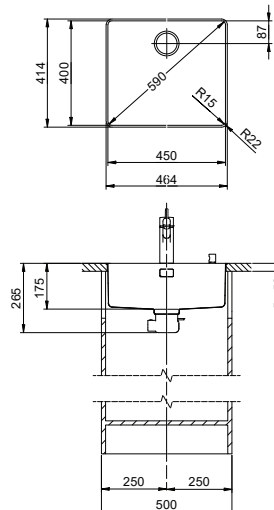

eFlow mit eControl
eFlow con eControl

Schwenkbare Überlaufkappe
Placchetta di troppopieno a ribalta

Desino: Verdeckter Ablauf mit untenliegendem Sieb
Desino: Scarico coperto con griglietta inferiore



Für eFlow Desino
Per eFlow Desino

Für TouchFlow Desino und Raumspaar Desino
Per TouchFlow Desino e Salvaspazio Desino



Für eFlow Desino, TouchFlow Desino und Raumspaar Desino
Per eFlow Desino, TouchFlow Desino e Salvaspazio Desino

Optionales Zubehör / Accessori opzionali

310



Resteschale gelocht
Vaschetta forato
CHF 106.– 40.000.912.00



Resteschale ungelocht
Vaschetta non forato
CHF 106.– 40.001.289.00



Schneidebrett aus Glas
Tagliere in vetro
CHF 151.– 40.000.909.00



Schneidebrett aus Kunststoff
Tagliere sintetico
CHF 151.– 40.001.277.00

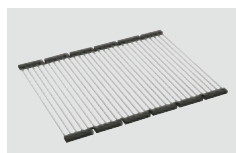

Inox Pad
CHF 125.– 40.001.138.00

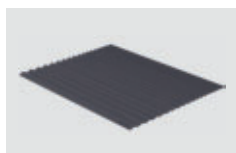

Maro Abtropfmatte aus Silikon
Maro tappetino scolapiatti in silicone
CHF 51.– 40.002.008.00

Zeichnung als pdf / dxf und Montageanleitung siehe:
V. disegno in formato pdf / dxf e montaggio:
suter.ch

Nur für flächenbündigen Einbau erhältlich.
Disponibile solo per montaggio a filo top.

Flächenbündiger Einbau: Empfehlung zur Wahl der Arbeitsplatte

Wir empfehlen den Einbau in Arbeitsplatten aus Keramik, Granit, Kunststein (z.B. Corian oder Varicor) oder Massivholz. Vom Einbau in beschichtete Spanplatten raten wir ab.

Montaggio a filo top: Consiglio per la scelta del piano di lavoro

Consigliamo il montaggio nei piani di lavoro in ceramica, granito, pietra artificiale (per es. Corian o Varicor) oppure in legno massiccio. Sconsigliamo la posa in pannelli di truciolato rivestiti.

Preis CHF/Prezzo in CHF

Modell Modello	Material Materiale	Ventil sFlow, Typ M Piletta sFlow, tipo M	Artikel-Nr. N. di articolo	Beckentiefe Profondità	Exkl. MWST IVA esclusa	Inkl. MWST IVA inclusa	VRG TRA
Linero LIO 45F/7	Edelstahl, matt Acciaio inox, opaco	18/10	3 1/2" eFlow Desino	10.105.241.00	175 mm	A 1875.–	2027.– 0.19
		3 1/2" TouchFlow Desino	10.105.242.00	175 mm	A 1760.–	1903.– 0.19	
		3 1/2" Raumspaar Desino Salvaspazio Desino	10.105.243.00	175 mm	A 1550.–	1676.–	

Linero: LIO 50F/7

Randbreite 7 mm
Larghezza bordo 7 mm

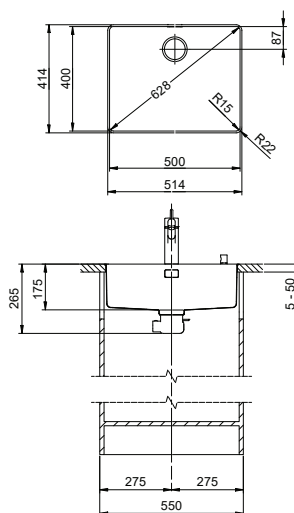

eFlow mit eControl
eFlow con eControl

Schwenkbare Überlaufkappe
Placchetta di troppopieno a ribalta

Desino: Verdeckter Ablauf mit untenliegendem Sieb
Desino: Scarico coperto con griglietta inferiore



Für eFlow Desino
Per eFlow Desino

Für TouchFlow Desino und Raumspär Desino
Per TouchFlow Desino e Salvaspazio Desino



Für eFlow Desino, TouchFlow Desino und Raumspär Desino
Per eFlow Desino, TouchFlow Desino e Salvaspazio Desino

Optionales Zubehör / Accessori opzionali

310



Resteschale gelocht
Vaschetta forato
CHF 106.- 40.000.912.00



Resteschale ungelocht
Vaschetta non forato
CHF 106.- 40.001.289.00

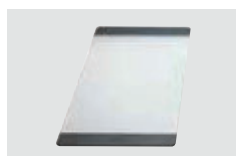

Schneidebrett aus Glas
Tagliere in vetro
CHF 151.- 40.000.909.00



Schneidebrett aus Kunststoff
Tagliere sintetico
CHF 151.- 40.001.277.00

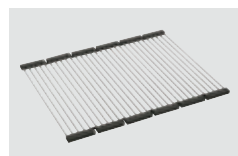

Inox Pad
CHF 125.- 40.001.138.00

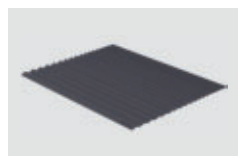

Maro Abtropfmatte aus Silikon
Maro tappetino scolapiatti in silicone
CHF 51.- 40.002.008.00

Zeichnung als pdf / dxf und Montageanleitung siehe:
V. disegno in formato pdf / dxf e montaggio:
suter.ch

Nur für flächenbündigen Einbau erhältlich.
Disponibile solo per montaggio a filo top.

Flächenbündiger Einbau: Empfehlung zur Wahl der Arbeitsplatte

Wir empfehlen den Einbau in Arbeitsplatten aus Keramik, Granit, Kunststein (z.B. Corian oder Varicor) oder Massivholz. Vom Einbau in beschichtete Spanplatten raten wir ab.

Montaggio a filo top: Consiglio per la scelta del piano di lavoro

Consigliamo il montaggio nei piani di lavoro in ceramica, granito, pietra artificiale (per es. Corian o Varicor) oppure in legno massiccio. Sconsigliamo la posa in pannelli di truciolato rivestiti.

Preis CHF / Prezzo in CHF

Modell Modello	Material Materiale	Ventil sFlow, Typ M Piletta sFlow, tipo M	Artikel-Nr. N. di articolo	Beckentiefe Profondità	Exkl. MWST IVA esclusa	Inkl. MWST IVA inclusa	VRG TRA
Linero LIO 50F/7	Edelstahl, matt Acciaio inox, opaco	18/10	3 1/2" eFlow Desino	10.105.244.00	175 mm	A 1904.-	2058.- 0.19
			3 1/2" TouchFlow Desino	10.105.245.00	175 mm	A 1789.-	1934.- 0.19
			3 1/2" Raumspär Desino Salvaspazio Desino	10.105.246.00	175 mm	A 1579.-	1707.-

Linero: LIO 55F/7

Randbreite 7 mm
Larghezza bordo 7 mm

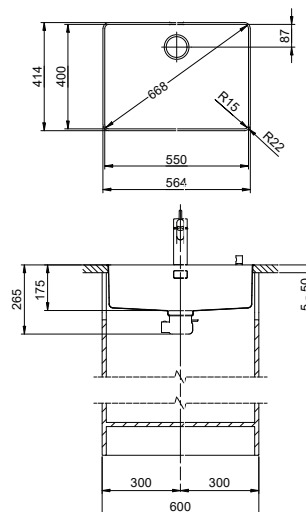

eFlow mit eControl
eFlow con eControl

Schwenkbare Überlaufkappe
Placchetta di troppopieno a ribalta

Desino: Verdeckter Ablauf mit untenliegendem Sieb
Desino: Scarico coperto con griglietta inferiore



Für eFlow Desino
Per eFlow Desino

Für TouchFlow Desino und Raumspaar Desino
Per TouchFlow Desino e Salvaspazio Desino



Für eFlow Desino, TouchFlow Desino und Raumspaar Desino
Per eFlow Desino, TouchFlow Desino e Salvaspazio Desino

Optionales Zubehör / Accessori opzionali

310



Resteschale gelocht
Vaschetta forato
CHF 106.- 40.000.912.00



Resteschale ungelocht
Vaschetta non forato
CHF 106.- 40.001.289.00



Schneidebrett aus Glas
Tagliere in vetro
CHF 151.- 40.000.909.00



Schneidebrett aus Kunststoff
Tagliere sintetico
CHF 151.- 40.001.277.00

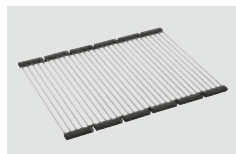

Inox Pad
CHF 125.- 40.001.138.00

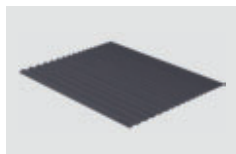

Maro Abtropfmatte aus Silikon
Maro tappetino scolapiatti in silicone
CHF 51.- 40.002.008.00

Zeichnung als pdf / dxf und Montageanleitung siehe:
V. disegno in formato pdf / dxf e montaggio:
suter.ch

Nur für flächenbündigen Einbau erhältlich.
Disponibile solo per montaggio a filo top.

Flächenbündiger Einbau: Empfehlung zur Wahl der Arbeitsplatte

Wir empfehlen den Einbau in Arbeitsplatten aus Keramik, Granit, Kunststein (z.B. Corian oder Varicor) oder Massivholz. Vom Einbau in beschichtete Spanplatten raten wir ab.

Montaggio a filo top: Consiglio per la scelta del piano di lavoro

Consigliamo il montaggio nei piani di lavoro in ceramica, granito, pietra artificiale (per es. Corian o Varicor) oppure in legno massiccio. Sconsigliamo la posa in pannelli di truciolato rivestiti.

Preis CHF / Prezzo in CHF

Modell Modello	Material Materiale	Ventil sFlow, Typ M Piletta sFlow, tipo M	Artikel-Nr. N. di articolo	Beckentiefe Profondità	Exkl. MWST IVA esclusa	Inkl. MWST IVA inclusa	VRG TRA	
Linero LIO 55F/7	Edelstahl, matt Acciaio inox, opaco	18/10	3 1/2" eFlow Desino	10.105.247.00	175 mm	A 2004.-	2166.-	0.19
		3 1/2" TouchFlow Desino	10.105.248.00	175 mm	A 1889.-	2042.-	0.19	
		3 1/2" Raumspaar Desino Salvaspazio Desino	10.105.249.00	175 mm	A 1679.-	1815.-		

Daneo: DAN 18IF/12

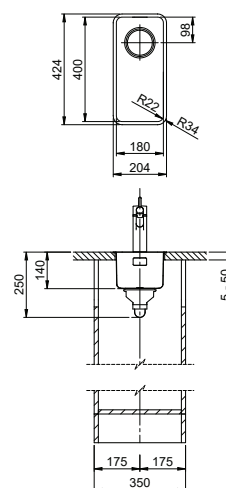
Randbreite 12 mm
Larghezza bordo 12 mm

 Schwenkbare Überlaufkappe
Placchetta di troppieno a ribalta

27

 Obenliegendes Sieb
Griglietta superiore

26



Zeichnung als pdf / dxf und Montageanleitung siehe:
V. disegno in formato pdf / dxf e montaggio:
suter.ch

Optionales Zubehör / Accessori opzionali

310

Resteschale gelocht
Vaschetta forato

CHF 106.– 40.000.912.00

Resteschale ungelocht
Vaschetta non forato

CHF 106.– 40.001.289.00

Schneidebrett aus Kunststoff
Tagliere sintetico

CHF 151.– 40.001.277.00

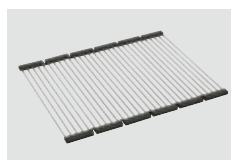
**Inox Pad**

CHF 125.– 40.001.138.00

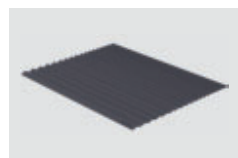
Maro Abtropfmatte aus Silikon
Maro tappetino scolapiatti in silicone

CHF 51.– 40.002.008.00

Flächenbündiger Einbau: Empfehlung zur Wahl der Arbeitsplatte

Wir empfehlen den Einbau in Arbeitsplatten aus Keramik, Granit, Kunststein (z.B. Corian oder Varicor) oder Massivholz. Vom Einbau in beschichtete Spanplatten raten wir ab.

Montaggio a filo top: Consiglio per la scelta del piano di lavoro

Consigliamo il montaggio nei piani di lavoro in ceramica, granito, pietra artificiale (per es. Corian o Varicor) oppure in legno massiccio. Sconsigliamo la posa in pannelli di truciolato rivestiti.

1 Produktausführung, 2 Montagearten

Der besondere Vorteil von IF-Modellen: Sowohl der flächenbündige Einbau als auch der flach aufliegende Einbau ist möglich.

1 versione di prodotto, 2 metodi di montaggio

I modelli IF presentano un grande vantaggio: possono essere posati sia a filo top che sopra piano.

Preis CHF / Prezzo in CHF

Modell Modello	Material Materiale	Ventil sFlow, Typ S Piletta sFlow, tipo S	Artikel-Nr. N. di articolo	Beckentiefe Profondità	Exkl. MWST IVA esclusa	Inkl. MWST IVA inclusa
Daneo DAN 18IF/12	Edelstahl, matt 18/10 Acciaio inox, opaco	3 1/2" Tipo	10.104.814.00	140 mm	A 809.–	875.–

Daneo: DAN 18IF/12

Randbreite 12 mm
Larghezza bordo 12 mm

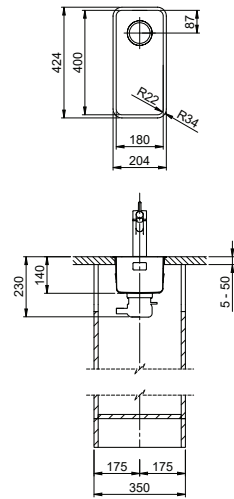

eFlow mit eControl
eFlow con eControl

Schwenkbare Überlaufkappe
Placchetta di troppopieno a ribalta

Desino: Verdeckter Ablauf mit untenliegendem Sieb
Desino: Scarico coperto con griglietta inferiore



Für eFlow Desino
Per eFlow Desino



Für TouchFlow Desino
Per TouchFlow Desino



Für eFlow Desino und TouchFlow Desino
Per eFlow Desino e TouchFlow Desino

Optionales Zubehör / Accessori opzionali

310



Resteschale gelocht
Vaschetta forato
CHF 106.– 40.000.912.00



Resteschale ungelocht
Vaschetta non forato
CHF 106.– 40.001.289.00



Schneidebrett aus Kunststoff
Tagliere sintetico
CHF 151.– 40.001.277.00

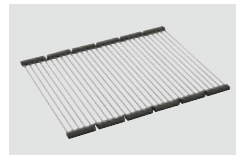

Inox Pad
CHF 125.– 40.001.138.00

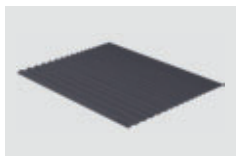

Maro Abtropfmatte aus Silikon
Maro tappetino scolapiatti in silicone
CHF 51.– 40.002.008.00

Zeichnung als pdf / dxf und Montageanleitung siehe:
V. disegno in formato pdf / dxf e montaggio:
suter.ch

Flächenbündiger Einbau: Empfehlung zur Wahl der Arbeitsplatte

Wir empfehlen den Einbau in Arbeitsplatten aus Keramik, Granit, Kunststein (z.B. Corian oder Varicor) oder Massivholz. Vom Einbau in beschichtete Spanplatten raten wir ab.

Montaggio a filo top: Consiglio per la scelta del piano di lavoro

Consigliamo il montaggio nei piani di lavoro in ceramica, granito, pietra artificiale (per es. Corian o Varicor) oppure in legno massiccio. Sconsigliamo la posa in pannelli di truciolato rivestiti.

1 Produktausführung, 2 Montagearten

Der besondere Vorteil von IF-Modellen: Sowohl der flächenbündige Einbau als auch der flach aufliegende Einbau ist möglich.

1 versione di prodotto, 2 metodi di montaggio

I modelli IF presentano un grande vantaggio: possono essere posati sia a filo top che soprapiano.

Preis CHF / Prezzo in CHF

Modell Modello	Material Materiale		Ventil sFlow, Typ M Piletta sFlow, tipo M	Artikel-Nr. N. di articolo		Beckentiefe Profondità	Exkl. MWST IVA esclusa	Inkl. MWST IVA inclusa	VRG TRA
Daneo DAN 18IF/12	Edelstahl, matt Acciaio inox, opaco	18/10	3 1/2" eFlow Desino	10.104.669.00		140 mm	A 1315.–	1422.–	0.19
			3 1/2" TouchFlow Desino	10.104.642.00		140 mm	A 1200.–	1297.–	0.19

Daneo: DAN 34F/7

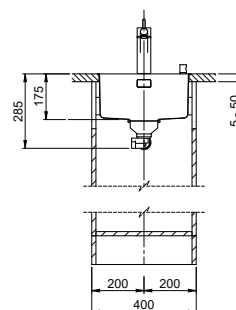
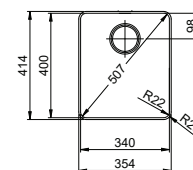
Randbreite 7 mm
Larghezza bordo 7 mm

 Schwenkbare Überlaufkappe
Placchetta di troppopieno a ribalta

27

 Obenliegendes Sieb
Griglietta superiore

26

 Zeichnung als pdf / dxf und Montageanleitung siehe:
V. disegno in formato pdf / dxf e montaggio:
suter.ch

Optionales Zubehör / Accessori opzionali

310

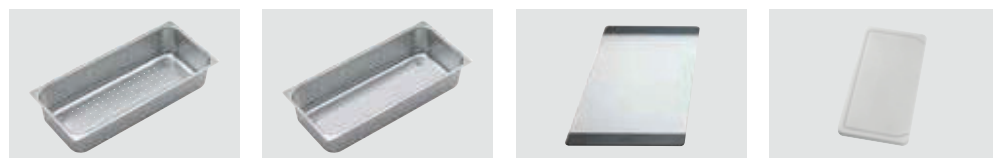
Resteschale gelocht
Vaschetta forata

CHF 106.– 40.000.912.00

Resteschale ungelocht
Vaschetta non forata

CHF 106.– 40.001.289.00

Schneidebrett aus Glas
Tagliere in vetro

CHF 151.– 40.000.909.00

Schneidebrett aus Kunststoff
Tagliere sintetico

CHF 151.– 40.001.277.00

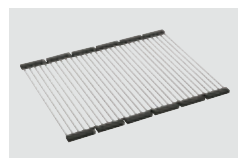
**Innox Pad**

CHF 125.– 40.001.138.00

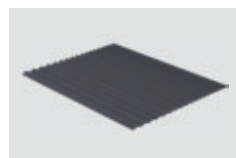
Maro Abtropfmatte aus Silikon
Maro tappetino scolapiatti in silicone

CHF 51.– 40.002.008.00

Nur für flächenbündigen Einbau erhältlich.
Disponibile solo per montaggio a filo top.

Flächenbündiger Einbau: Empfehlung zur Wahl der Arbeitsplatte

Wir empfehlen den Einbau in Arbeitsplatten aus Keramik, Granit, Kunststein (z.B. Corian oder Varicor) oder Massivholz. Vom Einbau in beschichtete Spanplatten raten wir ab.

Montaggio a filo top: Consiglio per la scelta del piano di lavoro

Consigliamo il montaggio nei piani di lavoro in ceramica, granito, pietra artificiale (per es. Corian o Varicor) oppure in legno massiccio. Sconsigliamo la posa in pannelli di truciolato rivestiti.

Varianten: Für die flächenbündige Spüle Daneo mit Standard Zugknopf Advant Chrom bestellen Sie
xx.xxx.xx.01 Standardartikel ohne Zugknopf. Reduktion CHF 24.–. Im Austausch wählen Sie den gewünschten Zugknopf auf Seite 358.
Varianti: per il lavello a filo top Daneo con pomolo standard Advant cromato, ordinate
xx.xxx.xx.01 – Articolo standard senza pomolo. Riduzione di CHF 24.–. In sostituzione, scegliete il pomolo desiderato a pagina 358.

Preis CHF/Prezzo in CHF

Modell Modello	Material Materiale	Ventil sFlow, Typ S Piletta sFlow, tipo S	Artikel-Nr. N. di articolo	Beckentiefe Profondità	Exkl. MWST IVA esclusa	Inkl. MWST IVA inclusa	VRG TRA	
Daneo DAN 34F/7	Edelstahl, matt Acciaio inox, opaco	18/10	3 1/2" TouchFlow	10.104.163.00	175 mm	A 1378.–	1490.–	0.19
			3 1/2" Raumspaar Salvaspazio	10.104.164.00	175 mm	A 1180.–	1276.–	
			3 1/2" Tipo	10.104.165.00	175 mm	A 1139.–	1231.–	

Daneo: DAN 34F/7

Randbreite 7 mm
Larghezza bordo 7 mm

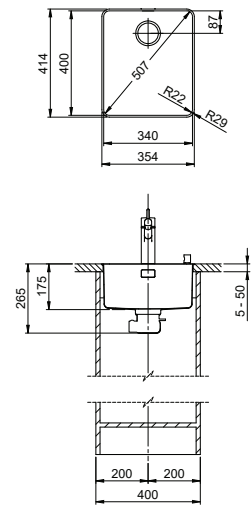

eFlow mit eControl
eFlow con eControl

Schwenkbare Überlaufkappe
Placchetta di troppopieno a ribalta

Desino: Verdeckter Ablauf mit untenliegendem Sieb
Desino: Scarico coperto con griglietta inferiore



Für eFlow Desino
Per eFlow Desino

Für TouchFlow Desino und Raumspas Desino
Per TouchFlow Desino e Salvaspazio Desino

Für eFlow Desino, TouchFlow Desino und Raumspas Desino
Per eFlow Desino, TouchFlow Desino e Salvaspazio Desino

Optionales Zubehör / Accessori opzionali

310



Resteschale gelocht
Vaschetta forato
CHF 106.– 40.000.912.00



Resteschale ungelocht
Vaschetta non forato
CHF 106.– 40.001.289.00

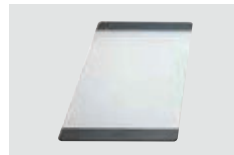

Schneidebrett aus Glas
Tagliere in vetro
CHF 151.– 40.000.909.00



Schneidebrett aus Kunststoff
Tagliere sintetico
CHF 151.– 40.001.277.00

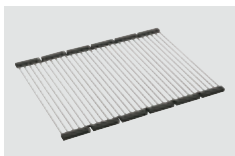

Inox Pad
CHF 125.– 40.001.138.00

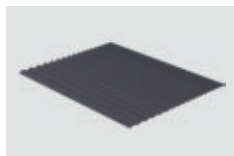

Maro Abtropfmatte aus Silikon
Maro tappetino scolapiatti in silicone
CHF 51.– 40.002.008.00

Zeichnung als pdf / dxf und Montageanleitung siehe:
V. disegno in formato pdf / dxf e montaggio:
suter.ch

Nur für flächenbündigen Einbau erhältlich.
Disponibile solo per montaggio a filo top.

Flächenbündiger Einbau: Empfehlung zur Wahl der Arbeitsplatte

Wir empfehlen den Einbau in Arbeitsplatten aus Keramik, Granit, Kunststein (z.B. Corian oder Varicor) oder Massivholz. Vom Einbau in beschichtete Spanplatten raten wir ab.

Montaggio a filo top: Consiglio per la scelta del piano di lavoro

Consigliamo il montaggio nei piani di lavoro in ceramica, granito, pietra artificiale (per es. Corian o Varicor) oppure in legno massiccio. Sconsigliamo la posa in pannelli di truciolato rivestiti.

Varianten: Für die flächenbündige Spüle Daneo mit Standard Zugknopf Advant Chrom bestellen Sie xx.xxx.xx.01 Standardartikel ohne Zugknopf. Reduktion CHF 24.–. Im Austausch wählen Sie den gewünschten Zugknopf auf Seite 358.
Varianti: per il lavello a filo top Daneo con pomolo standard Advant cromato, ordinate xx.xxx.xx.01 – Articolo standard senza pomolo. Riduzione di CHF 24.–. In sostituzione, scegliete il pomolo desiderato a pagina 358.

Preis CHF / Prezzo in CHF

Modell Modello	Material Materiale	Ventil sFlow, Typ M Piletta sFlow, tipo M	Artikel-Nr. N. di articolo	Beckentiefe Profondità	Exkl. MWST IVA esclusa	Inkl. MWST IVA inclusa	VRG TRA		
Daneo DAN 34F/7	Edelstahl, matt Acciaio inox, opaco	18/10	3 1/2" eFlow Desino	10.104.670.00	175 mm	A	1645.–	1778.–	0.19
			3 1/2" TouchFlow Desino	10.104.643.00	175 mm	A	1530.–	1654.–	0.19
			3 1/2" Raumspas Desino Salvaspazio Desino	10.104.644.00	175 mm	A	1320.–	1427.–	

Daneo: DAN 34IF/12

Randbreite 12 mm
Larghezza bordo 12 mm

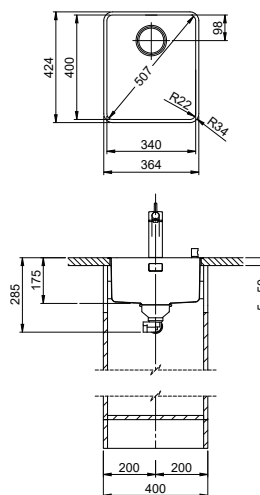

Schwenkbare Überlaufkappe
Placchetta di troppopieno a ribalta

Obenliegendes Sieb
Griglietta superiore

26



Zeichnung als pdf / dxf und Montageanleitung siehe:
V. disegno in formato pdf / dxf e montaggio:
suter.ch

Optionales Zubehör / Accessori opzionali

310

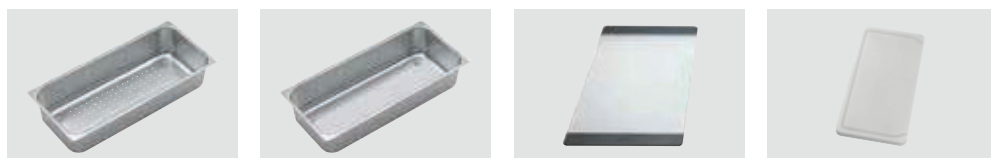

Resteschale gelocht
Vaschetta forato
CHF 106.– 40.000.912.00

Resteschale ungelocht
Vaschetta non forato
CHF 106.– 40.001.289.00

Schneidebrett aus Glas
Tagliere in vetro
CHF 151.– 40.000.909.00

Schneidebrett aus Kunststoff
Tagliere sintetico
CHF 151.– 40.001.277.00

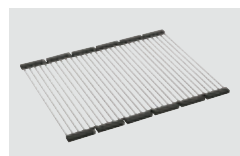

Inox Pad
CHF 125.– 40.001.138.00

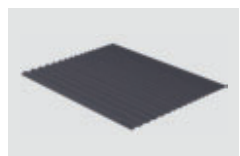

Maro Abtropfmatte aus Silikon
Maro tappetino scolapiatti in silicone
CHF 51.– 40.002.008.00

Flächenbündiger Einbau: Empfehlung zur Wahl der Arbeitsplatte

Wir empfehlen den Einbau in Arbeitsplatten aus Keramik, Granit, Kunststein (z.B. Corian oder Varicor) oder Massivholz. Vom Einbau in beschichtete Spanplatten raten wir ab.

Montaggio a filo top: Consiglio per la scelta del piano di lavoro

Consigliamo il montaggio nei piani di lavoro in ceramica, granito, pietra artificiale (per es. Corian o Varicor) oppure in legno massiccio. Sconsigliamo la posa in pannelli di truciolato rivestiti.

1 Produktausführung, 2 Montagearten

Der besondere Vorteil von IF-Modellen: Sowohl der flächenbündige Einbau als auch der flach aufliegende Einbau ist möglich.

1 versione di prodotto, 2 metodi di montaggio

I modelli IF presentano un grande vantaggio: possono essere posati sia a filo top che sopra piano.

Varianten: Für die flächenbündige Spüle Daneo mit Standard Zugknopf Advant Chrom bestellen Sie
xx.xxx.xx.01 Standardartikel ohne Zugknopf. Reduktion CHF 24.–. Im Austausch wählen Sie den gewünschten Zugknopf auf Seite 358.
Varianti: per il lavello a filo top Daneo con pomolo standard Advant cromato, ordinate
xx.xxx.xx.01 – Articolo standard senza pomolo. Riduzione di CHF 24.–. In sostituzione, scegliete il pomolo desiderato a pagina 358.

Preis CHF/Prezzo in CHF

Modell Modello	Material Materiale	Ventil sFlow, Typ S Piletta sFlow, tipo S	Artikel-Nr. N. di articolo	Beckentiefe Profondità	Exkl. MWST IVA esclusa	Inkl. MWST IVA inclusa	VRG TRA
Daneo DAN 34IF/12	Edelstahl, matt Acciaio inox, opaco	18/10	3 1/2" TouchFlow	10.104.200.00	175 mm	A 1322.–	1429.– 0.19
			3 1/2" Raumspär Salvaspazio	10.104.201.00	175 mm	A 1124.–	1215.–
			3 1/2" Tipo	10.104.202.00	175 mm	A 1083.–	1171.–

Daneo: DAN 34IF/12

Randbreite 12 mm
Larghezza bordo 12 mm

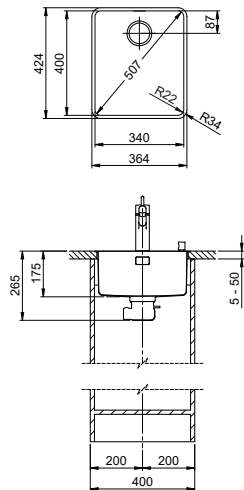

eFlow mit eControl
eFlow con eControl

Schwenkbare Überlaufkappe
Placchetta di troppopieno a ribalta

Desino: Verdeckter Ablauf mit untenliegendem Sieb
Desino: Scarico coperto con griglietta inferiore



Für eFlow Desino
Per eFlow Desino



Für TouchFlow Desino und Raumspär Desino
Per TouchFlow Desino e Salvaspazio Desino



Für eFlow Desino, TouchFlow Desino und Raumspär Desino
Per eFlow Desino, TouchFlow Desino e Salvaspazio Desino

Optionales Zubehör / Accessori opzionali

310



Resteschale gelocht
Vaschetta forata
CHF 106.– 40.000.912.00



Resteschale ungelocht
Vaschetta non forata
CHF 106.– 40.001.289.00

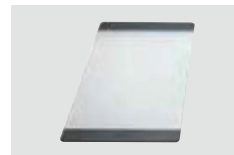

Schneidebrett aus Glas
Tagliere in vetro
CHF 151.– 40.000.909.00



Schneidebrett aus Kunststoff
Tagliere sintetico
CHF 151.– 40.001.277.00

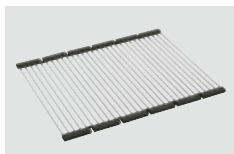

Inox Pad
CHF 125.– 40.001.138.00

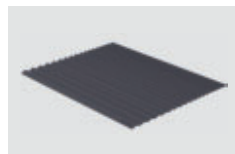

Maro Abtropfmatte aus Silikon
Maro tappetino scolapiatti in silicone
CHF 51.– 40.002.008.00

Zeichnung als pdf / dxf und Montageanleitung siehe:
V. disegno in formato pdf / dxf e montaggio:
suter.ch

Flächenbündiger Einbau: Empfehlung zur Wahl der Arbeitsplatte

Wir empfehlen den Einbau in Arbeitsplatten aus Keramik, Granit, Kunststein (z.B. Corian oder Varicor) oder Massivholz. Vom Einbau in beschichtete Spanplatten raten wir ab.

Montaggio a filo top: Consiglio per la scelta del piano di lavoro

Consigliamo il montaggio nei piani di lavoro in ceramica, granito, pietra artificiale (per es. Corian o Varicor) oppure in legno massiccio. Sconsigliamo la posa in pannelli di truciolato rivestiti.

1 Produktausführung, 2 Montagearten

Der besondere Vorteil von IF-Modellen: Sowohl der flächenbündige Einbau als auch der flach aufliegende Einbau ist möglich.

1 versione di prodotto, 2 metodi di montaggio

I modelli IF presentano un grande vantaggio: possono essere posati sia a filo top che sopra piano.

Varianten: Für die flächenbündige Spüle Daneo mit Standard Zugknopf Advant Chrom bestellen Sie
xx.xxx.xx.01 Standardartikel ohne Zugknopf. Reduktion CHF 24.–. Im Austausch wählen Sie den gewünschten Zugknopf auf Seite 358.
Varianti: per il lavello a filo top Daneo con pomolo standard Advant cromato, ordinate
xx.xxx.xx.01 – Articolo standard senza pomolo. Riduzione di CHF 24.–. In sostituzione, scegliete il pomolo desiderato a pagina 358.

Preis CHF/Prezzo in CHF

Modell Modello	Material Materiale	Ventil sFlow, Typ M Piletta sFlow, tipo M	Artikel-Nr. N. di articolo	Beckentiefe Profondità	Exkl. MWST IVA esclusa	Inkl. MWST IVA inclusa	VRG TRA	
Daneo DAN 34IF/12	Edelstahl, matt Acciaio inox, opaco	18/10	3 1/2" eFlow Desino	10.104.671.00	175 mm	A 1589.–	1718.–	0.19
			3 1/2" TouchFlow Desino	10.104.645.00	175 mm	A 1474.–	1593.–	0.19
			3 1/2" Raumspär Desino Salvaspazio Desino	10.104.646.00	175 mm	A 1264.–	1366.–	

Daneo: DAN 40F/7

Randbreite 7 mm
Larghezza bordo 7 mm

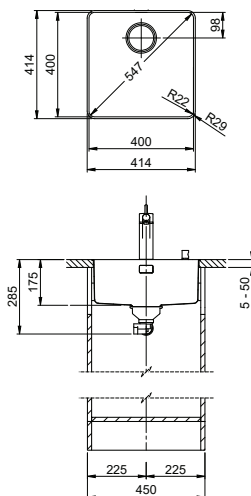

Schwenkbare Überlaufkappe
Placchetta di troppopieno a ribalta

27 Obenliegendes Sieb
Griglietta superiore

26



Zeichnung als pdf / dxf und Montageanleitung siehe:
V. disegno in formato pdf / dxf e montaggio:
suter.ch

Optionales Zubehör / Accessori opzionali

310

Resteschale gelocht Vaschetta forato	Resteschale ungelocht Vaschetta non forato	Schneidebrett aus Glas Tagliere in vetro	Schneidebrett aus Kunststoff Tagliere sintetico
CHF 106.– 40.000.912.00	CHF 106.– 40.001.289.00	CHF 151.– 40.000.909.00	CHF 151.– 40.001.277.00
Inox Pad	Maro Abtropfmatte aus Silikon Maro tappetino scolapiatti in silicone		
CHF 125.– 40.001.138.00	CHF 51.– 40.002.008.00		

Nur für flächenbündigen Einbau erhältlich.
Disponibile solo per montaggio a filo top.

Flächenbündiger Einbau: Empfehlung zur Wahl der Arbeitsplatte

Wir empfehlen den Einbau in Arbeitsplatten aus Keramik, Granit, Kunststein (z.B. Corian oder Varicor) oder Massivholz. Vom Einbau in beschichtete Spanplatten raten wir ab.

Montaggio a filo top: Consiglio per la scelta del piano di lavoro

Consigliamo il montaggio nei piani di lavoro in ceramica, granito, pietra artificiale (per es. Corian o Varicor) oppure in legno massiccio. Sconsigliamo la posa in pannelli di truciolato rivestiti.

Varianten: Für die flächenbündige Spüle Daneo mit Standard Zugknopf Advant Chrom bestellen Sie
xx.xxx.xx.01 Standardartikel ohne Zugknopf. Reduktion CHF 24.–. Im Austausch wählen Sie den gewünschten Zugknopf auf Seite 358.
Varianti: per il lavello a filo top Daneo con pomolo standard Advant cromato, ordinate
xx.xxx.xx.01 – Articolo standard senza pomolo. Riduzione di CHF 24.–. In sostituzione, scegliete il pomolo desiderato a pagina 358.

Preis CHF/Prezzo in CHF

Modell Modello	Material Materiale	Ventil sFlow, Typ S Piletta sFlow, tipo S	Artikel-Nr. N. di articolo	Beckentiefe Profondità	Exkl. MWST IVA esclusa	Inkl. MWST IVA inclusa	VRG TRA
Daneo DAN 40F/7	Edelstahl, matt Acciaio inox, opaco	18/10 3 1/2" TouchFlow	10.104.166.00	175 mm	A 1444.–	1561.–	0.19
		3 1/2" Raumspär Salvaspazio	10.104.167.00	175 mm	A 1246.–	1347.–	
		3 1/2" Tipo	10.104.168.00	175 mm	A 1205.–	1303.–	

Daneo: DAN 40F/7

Randbreite 7 mm
Larghezza bordo 7 mm

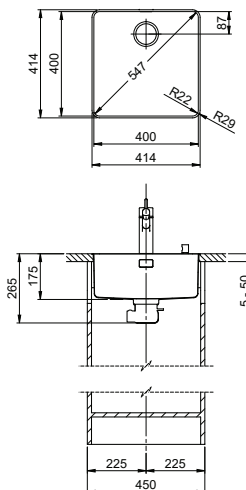

eFlow mit eControl
eFlow con eControl

Schwenkbare Überlaufkappe
Placchetta di troppopieno a ribalta

Desino: Verdeckter Ablauf mit untenliegendem Sieb
Desino: Scarico coperto con griglietta inferiore



Für eFlow Desino
Per eFlow Desino

Für TouchFlow Desino und Raumspar Desino
Per TouchFlow Desino e Salvaspazio Desino



Für eFlow Desino, TouchFlow Desino und Raumspar Desino
Per eFlow Desino, TouchFlow Desino e Salvaspazio Desino

Optionales Zubehör / Accessori opzionali

310



Resteschale gelocht
Vaschetta forato
CHF 106.– 40.000.912.00



Resteschale ungelocht
Vaschetta non forato
CHF 106.– 40.001.289.00

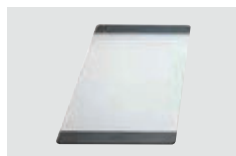

Schneidebrett aus Glas
Tagliere in vetro
CHF 151.– 40.000.909.00



Schneidebrett aus Kunststoff
Tagliere sintetico
CHF 151.– 40.001.277.00

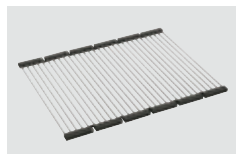

Inox Pad
CHF 125.– 40.001.138.00

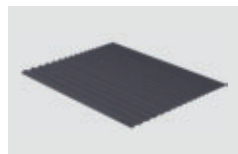

Maro Abtropfmatte aus Silikon
Maro tappetino scolapiatti in silicone
CHF 51.– 40.002.008.00

Zeichnung als pdf / dxf und Montageanleitung siehe:
V. disegno in formato pdf / dxf e montaggio:
suter.ch

Nur für flächenbündigen Einbau erhältlich.
Disponibile solo per montaggio a filo top.

Flächenbündiger Einbau: Empfehlung zur Wahl der Arbeitsplatte

Wir empfehlen den Einbau in Arbeitsplatten aus Keramik, Granit, Kunststein (z.B. Corian oder Varicor) oder Massivholz. Vom Einbau in beschichtete Spanplatten raten wir ab.

Montaggio a filo top: Consiglio per la scelta del piano di lavoro

Consigliamo il montaggio nei piani di lavoro in ceramica, granito, pietra artificiale (per es. Corian o Varicor) oppure in legno massiccio. Sconsigliamo la posa in pannelli di truciolato rivestiti.

Varianten: Für die flächenbündige Spüle Daneo mit Standard Zugknopf Advant Chrom bestellen Sie
xx.xxx.xx.01 Standardartikel ohne Zugknopf. Reduktion CHF 24.–. Im Austausch wählen Sie den gewünschten Zugknopf auf Seite 358.
Varianti: per il lavello a filo top Daneo con pomolo standard Advant cromato, ordinate
xx.xxx.xx.01 – Articolo standard senza pomolo. Riduzione di CHF 24.–. In sostituzione, scegliete il pomolo desiderato a pagina 358.

Preis CHF/Prezzo in CHF

Modell Modello	Material Materiale	Ventil sFlow, Typ M Piletta sFlow, tipo M	Artikel-Nr. N. di articolo	Beckentiefe Profondità	Exkl. MWST IVA esclusa	Inkl. MWST IVA inclusa	VRG TRA
Daneo DAN 40F/7	Edelstahl, matt Acciaio inox, opaco	18/10	3 1/2" eFlow Desino	10.104.672.00	175 mm	A 1711.–	1850.– 0.19
			3 1/2" TouchFlow Desino	10.104.647.00	175 mm	A 1596.–	1725.– 0.19
			3 1/2" Raumspar Desino Salvaspazio Desino	10.104.648.00	175 mm	A 1386.–	1498.–

Daneo: DAN 40IF/12

Randbreite 12 mm
Larghezza bordo 12 mm

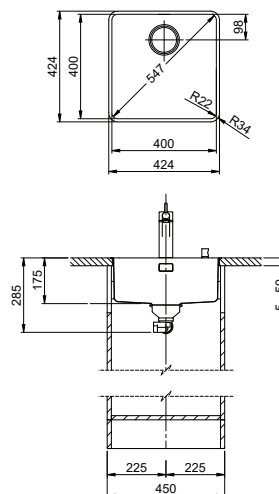

Schwenkbare Überlaufkappe
Placchetta di troppopieno a ribalta

Obenliegendes Sieb
Griglietta superiore

26



Zeichnung als pdf / dxf und Montageanleitung siehe:
V. disegno in formato pdf / dxf e montaggio:
suter.ch

Optionales Zubehör / Accessori opzionali

310

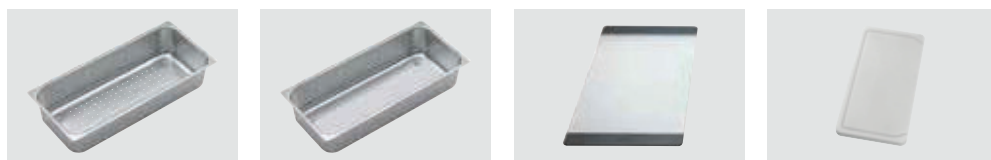

Resteschale gelocht
Vaschetta forata
CHF 106.– 40.000.912.00

Resteschale ungelocht
Vaschetta non forata
CHF 106.– 40.001.289.00

Schneidebrett aus Glas
Tagliere in vetro
CHF 151.– 40.000.909.00

Schneidebrett aus Kunststoff
Tagliere sintetico
CHF 151.– 40.001.277.00

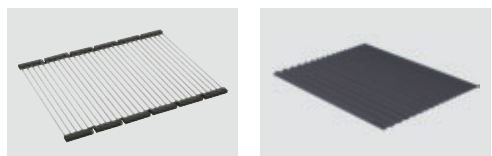

Inox Pad
CHF 125.– 40.001.138.00

Maro Abtropfmatte aus Silikon
Maro tappetino scolapiatti in silicone
CHF 51.– 40.002.008.00

Flächenbündiger Einbau: Empfehlung zur Wahl der Arbeitsplatte

Wir empfehlen den Einbau in Arbeitsplatten aus Keramik, Granit, Kunststein (z.B. Corian oder Varicor) oder Massivholz. Vom Einbau in beschichtete Spanplatten raten wir ab.

Montaggio a filo top: Consiglio per la scelta del piano di lavoro

Consigliamo il montaggio nei piani di lavoro in ceramica, granito, pietra artificiale (per es. Corian o Varicor) oppure in legno massiccio. Sconsigliamo la posa in pannelli di truciolato rivestiti.

1 Produktausführung, 2 Montagearten

Der besondere Vorteil von IF-Modellen: Sowohl der flächenbündige Einbau als auch der flach aufliegende Einbau ist möglich.

1 versione di prodotto, 2 metodi di montaggio

I modelli IF presentano un grande vantaggio: possono essere posati sia a filo top che soprapiano.

Varianten: Für die flächenbündige Spüle Daneo mit Standard Zugknopf Advant Chrom bestellen Sie
xx.xxx.xx.01 Standardartikel ohne Zugknopf. Reduktion CHF 24.–. Im Austausch wählen Sie den gewünschten Zugknopf auf Seite 358.
Varianti: per il lavello a filo top Daneo con pomolo standard Advant cromato, ordinate
xx.xxx.xx.01 – Articolo standard senza pomolo. Riduzione di CHF 24.–. In sostituzione, scegliete il pomolo desiderato a pagina 358.

Preis CHF/Prezzo in CHF

Modell Modello	Material Materiale		Ventil sFlow, Typ S Piletta sFlow, tipo S	Artikel-Nr. N. di articolo	Beckentiefe Profondità	Exkl. MWST IVA esclusa	Inkl. MWST IVA inclusa	VRG TRA	
Daneo DAN 40IF/12	Edelstahl, matt Acciaio inox, opaco	18/10	3 1/2" TouchFlow	10.104.203.00	175 mm	A	1385.–	1497.–	0.19
			3 1/2" Raumspär Salvaspazio	10.104.204.00	175 mm	A	1187.–	1283.–	
			3 1/2" Tipo	10.104.205.00	175 mm	A	1146.–	1239.–	

Daneo: DAN 40IF/12

Randbreite 12 mm
Larghezza bordo 12 mm

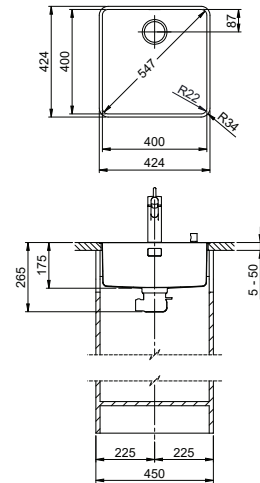

eFlow mit eControl
eFlow con eControl

Schwenkbare Überlaufkappe
Placchetta di troppopieno a ribalta

Desino: Verdeckter Ablauf mit untenliegendem Sieb
Desino: Scarico coperto con griglietta inferiore



Für eFlow Desino
Per eFlow Desino



Für TouchFlow Desino und Raumspars Desino
Per TouchFlow Desino e Salvaspazio Desino



Für eFlow Desino, TouchFlow Desino und Raumspars Desino
Per eFlow Desino, TouchFlow Desino e Salvaspazio Desino



Optionales Zubehör / Accessori opzionali

310



Resteschale gelocht
Vaschetta forata
CHF 106.– 40.000.912.00



Resteschale ungelocht
Vaschetta non forata
CHF 106.– 40.001.289.00

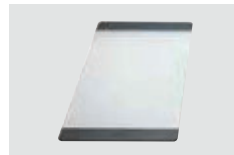

Schneidebrett aus Glas
Tagliere in vetro
CHF 151.– 40.000.909.00



Schneidebrett aus Kunststoff
Tagliere sintetico
CHF 151.– 40.001.277.00

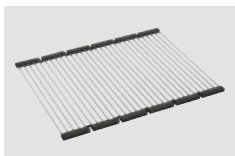

Inox Pad
CHF 125.– 40.001.138.00

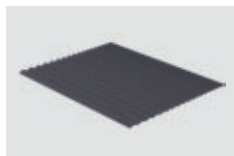

Maro Abtropfmatte aus Silikon
Maro tappetino scolapiatti in silicone
CHF 51.– 40.002.008.00

Zeichnung als pdf/dxf und Montageanleitung siehe:
V. disegno in formato pdf/dxf e montaggio:
suter.ch

Flächenbündiger Einbau: Empfehlung zur Wahl der Arbeitsplatte

Wir empfehlen den Einbau in Arbeitsplatten aus Keramik, Granit, Kunststein (z.B. Corian oder Varicor) oder Massivholz. Vom Einbau in beschichtete Spanplatten raten wir ab.

Montaggio a filo top: Consiglio per la scelta del piano di lavoro

Consigliamo il montaggio nei piani di lavoro in ceramica, granito, pietra artificiale (per es. Corian o Varicor) oppure in legno massiccio. Sconsigliamo la posa in pannelli di truciolato rivestiti.

1 Produktausführung, 2 Montagearten

Der besondere Vorteil von IF-Modellen: Sowohl der flächenbündige Einbau als auch der flach aufliegende Einbau ist möglich.

1 versione di prodotto, 2 metodi di montaggio

I modelli IF presentano un grande vantaggio: possono essere posati sia a filo top che sopra piano.

Varianten: Für die flächenbündige Spüle Daneo mit Standard Zugknopf Advant Chrom bestellen Sie
xx.xxx.xx.01 Standardartikel ohne Zugknopf. Reduktion CHF 24.–. Im Austausch wählen Sie den gewünschten Zugknopf auf Seite 358.
Varianti: per il lavello a filo top Daneo con pomolo standard Advant cromato, ordinate
xx.xxx.xx.01 – Articolo standard senza pomolo. Riduzione di CHF 24.–. In sostituzione, scegliete il pomolo desiderato a pagina 358.

Preis CHF/Prezzo in CHF

Modell Modello	Material Materiale	Ventil sFlow, Typ M Piletta sFlow, tipo M	Artikel-Nr. N. di articolo	Beckentiefe Profondità	Exkl. MWST IVA esclusa	Inkl. MWST IVA inclusa	VRG TRA
Daneo DAN 40IF/12	Edelstahl, matt Acciaio inox, opaco	18/10	3 1/2" eFlow Desino	10.104.673.00	175 mm	A 1652.–	1786.– 0.19
			3 1/2" TouchFlow Desino	10.104.649.00	175 mm	A 1537.–	1661.– 0.19
			3 1/2" Raumspars Desino Salvaspazio Desino	10.104.650.00	175 mm	A 1327.–	1434.–

Daneo: DAN 45F/7

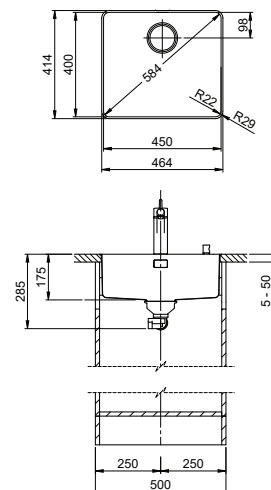
Randbreite 7 mm
Larghezza bordo 7 mm

 Schwenkbare Überlaufkappe
Placchetta di troppopieno a ribalta

27

 Obenliegendes Sieb
Griglietta superiore

26

 Zeichnung als pdf / dxf und Montageanleitung siehe:
 V. disegno in formato pdf / dxf e montaggio:
 suter.ch

Optionales Zubehör / Accessori opzionali

310

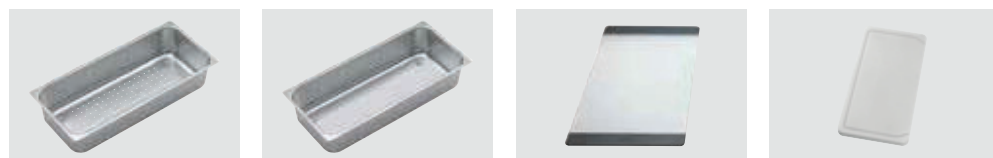
Resteschale gelocht
Vaschetta forata

CHF 106.– 40.000.912.00

Resteschale ungelocht
Vaschetta non forata

CHF 106.– 40.001.289.00

Schneidebrett aus Glas
Tagliere in vetro

CHF 151.– 40.000.909.00

Schneidebrett aus Kunststoff
Tagliere sintetico

CHF 151.– 40.001.277.00

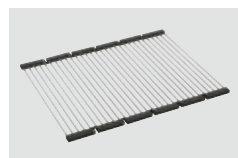
**Inox Pad**

CHF 125.– 40.001.138.00

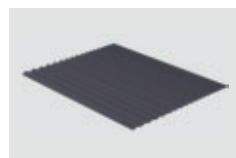
Maro Abtropfmatte aus Silikon
Maro tappetino scolapiatti in silicone

CHF 51.– 40.002.008.00

Nur für flächenbündigen Einbau erhältlich.
Disponibile solo per montaggio a filo top.
Flächenbündiger Einbau: Empfehlung zur Wahl der Arbeitsplatte

Wir empfehlen den Einbau in Arbeitsplatten aus Keramik, Granit, Kunststein (z.B. Corian oder Varicor) oder Massivholz. Vom Einbau in beschichtete Spanplatten raten wir ab.

Montaggio a filo top: Consiglio per la scelta del piano di lavoro

Consigliamo il montaggio nei piani di lavoro in ceramica, granito, pietra artificiale (per es. Corian o Varicor) oppure in legno massiccio. Sconsigliamo la posa in pannelli di truciolato rivestiti.

Varianten: Für die flächenbündige Spüle Daneo mit Standard Zugknopf Advant Chrom bestellen Sie
 xx.xxx.xx.01 Standardartikel ohne Zugknopf. Reduktion CHF 24.–. Im Austausch wählen Sie den gewünschten Zugknopf auf Seite 358.
Varianti: per il lavello a filo top Daneo con pomolo standard Advant cromato, ordinate
 xx.xxx.xx.01 – Articolo standard senza pomolo. Riduzione di CHF 24.–. In sostituzione, scegliete il pomolo desiderato a pagina 358.

Preis CHF/Prezzo in CHF

Modell Modello	Material Materiale		Ventil sFlow, Typ S Piletta sFlow, tipo S	Artikel-Nr. N. di articolo	Beckentiefe Profondità	Exkl. MWST IVA esclusa	Inkl. MWST IVA inclusa	VRG TRA	
Daneo DAN 45F/7	Edelstahl, matt Acciaio inox, opaco	18/10	3 1/2" TouchFlow	10.104.169.00	175 mm	A	1471.–	1590.–	0.19
			3 1/2" Raumspaar Salvaspazio	10.104.170.00	175 mm	A	1273.–	1376.–	
			3 1/2" Tipo	10.104.171.00	175 mm	A	1232.–	1332.–	

Daneo: DAN 45F/7

Randbreite 7 mm
Larghezza bordo 7 mm

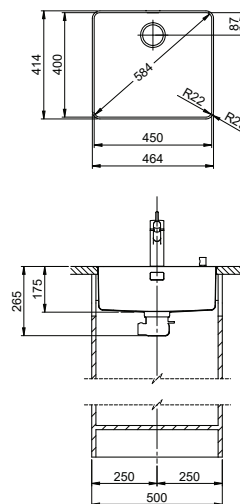

eFlow mit eControl
eFlow con eControl

Schwenkbare Überlaufkappe
Placchetta di troppopieno a ribalta

Desino: Verdeckter Ablauf mit untenliegendem Sieb
Desino: Scarico coperto con griglietta inferiore



Für eFlow Desino
Per eFlow Desino



Für TouchFlow Desino und Raumspars Desino
Per TouchFlow Desino e Salvaspazio Desino



Für eFlow Desino, TouchFlow Desino und Raumspars Desino
Per eFlow Desino, TouchFlow Desino e Salvaspazio Desino



Optionales Zubehör / Accessori opzionali

310



Resteschale gelocht
Vaschetta forato
CHF 106.– 40.000.912.00



Resteschale ungelocht
Vaschetta non forato
CHF 106.– 40.001.289.00

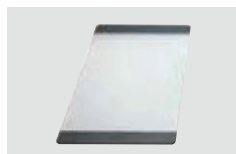

Schneidebrett aus Glas
Tagliere in vetro
CHF 151.– 40.000.909.00



Schneidebrett aus Kunststoff
Tagliere sintetico
CHF 151.– 40.001.277.00

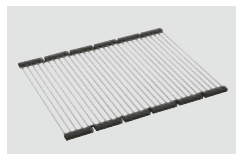

Inox Pad
CHF 125.– 40.001.138.00

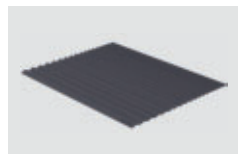

Maro Abtropfmatte aus Silikon
Maro tappetino scolapiatti in silicone
CHF 51.– 40.002.008.00

Zeichnung als pdf / dxf und Montageanleitung siehe:
V. disegno in formato pdf / dxf e montaggio:
suter.ch

Nur für flächenbündigen Einbau erhältlich.
Disponibile solo per montaggio a filo top.

Flächenbündiger Einbau: Empfehlung zur Wahl der Arbeitsplatte

Wir empfehlen den Einbau in Arbeitsplatten aus Keramik, Granit, Kunststein (z.B. Corian oder Varicor) oder Massivholz. Vom Einbau in beschichtete Spanplatten raten wir ab.

Montaggio a filo top: Consiglio per la scelta del piano di lavoro

Consigliamo il montaggio nei piani di lavoro in ceramica, granito, pietra artificiale (per es. Corian o Varicor) oppure in legno massiccio. Sconsigliamo la posa in pannelli di truciolato rivestiti.

Varianten: Für die flächenbündige Spüle Daneo mit Standard Zugknopf Advant Chrom bestellen Sie
xx.xxx.xx.01 Standardartikel ohne Zugknopf. Reduktion CHF 24.–. Im Austausch wählen Sie den gewünschten Zugknopf auf Seite 358.
Varianti: per il lavello a filo top Daneo con pomolo standard Advant cromato, ordinate
xx.xxx.xx.01 – Articolo standard senza pomolo. Riduzione di CHF 24.–. In sostituzione, scegliete il pomolo desiderato a pagina 358.

Preis CHF/Prezzo in CHF

Modell Modello	Material Materiale	Ventil sFlow, Typ M Piletta sFlow, tipo M	Artikel-Nr. N. di articolo	Beckentiefe Profondità	Exkl. MWST IVA esclusa	Inkl. MWST IVA inclusa	VRG TRA
Daneo DAN 45F/7	Edelstahl, matt Acciaio inox, opaco	18/10	3 1/2" eFlow Desino	10.104.674.00	175 mm	A 1738.–	1879.– 0.19
			3 1/2" TouchFlow Desino	10.104.651.00	175 mm	A 1623.–	1754.– 0.19
			3 1/2" Raumspars Desino Salvaspazio Desino	10.104.652.00	175 mm	A 1413.–	1527.–

Daneo: DAN 45IF/12

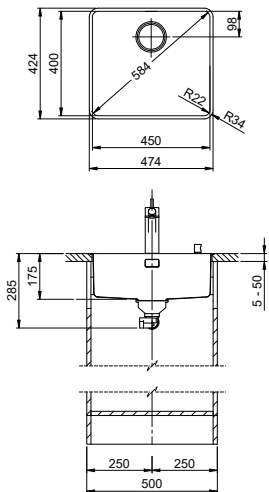
Randbreite 12 mm
Larghezza bordo 12 mm

 Schwenkbare Überlaufkappe
Placchetta di troppopieno a ribalta

27

 Obenliegendes Sieb
Griglietta superiore

26



Zeichnung als pdf / dxf und Montageanleitung siehe:
V. disegno in formato pdf / dxf e montaggio:
suter.ch

Optionales Zubehör / Accessori opzionali

310

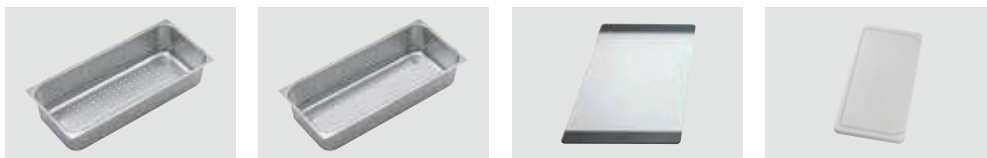
Resteschale gelocht
Vaschetta forato
CHF 106.– 40.000.912.00

Resteschale ungelocht
Vaschetta non forato
CHF 106.– 40.001.289.00

Schneidebrett aus Glas
Tagliere in vetro
CHF 151.– 40.000.909.00

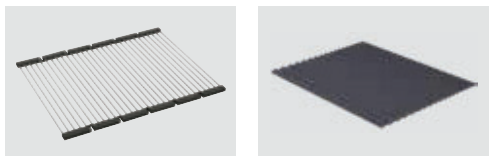
Schneidebrett aus Kunststoff
Tagliere sintetico
CHF 151.– 40.001.277.00

Inox Pad
CHF 125.– 40.001.138.00

Maro Abtropfmatte aus Silikon
Maro tappetino scolapiatti in silicone
CHF 51.– 40.002.008.00

Flächenbündiger Einbau: Empfehlung zur Wahl der Arbeitsplatte

Wir empfehlen den Einbau in Arbeitsplatten aus Keramik, Granit, Kunststein (z.B. Corian oder Varicor) oder Massivholz. Vom Einbau in beschichtete Spanplatten raten wir ab.

Montaggio a filo top: Consiglio per la scelta del piano di lavoro

Consigliamo il montaggio nei piani di lavoro in ceramica, granito, pietra artificiale (per es. Corian o Varicor) oppure in legno massiccio. Sconsigliamo la posa in pannelli di truciolato rivestiti.

1 Produktausführung, 2 Montagearten

Der besondere Vorteil von IF-Modellen: Sowohl der flächenbündige Einbau als auch der flach aufliegende Einbau ist möglich.

1 versione di prodotto, 2 metodi di montaggio

I modelli IF presentano un grande vantaggio: possono essere posati sia a filo top che sopra piano.

Varianten: Für die flächenbündige Spüle Daneo mit Standard Zugknopf Advant Chrom bestellen Sie
xx.xxx.xx.01 Standardartikel ohne Zugknopf. Reduktion CHF 24.–. Im Austausch wählen Sie den gewünschten Zugknopf auf Seite 358.
Varianti: per il lavello a filo top Daneo con pomolo standard Advant cromato, ordinate
xx.xxx.xx.01 – Articolo standard senza pomolo. Riduzione di CHF 24.–. In sostituzione, scegliete il pomolo desiderato a pagina 358.

Preis CHF/Prezzo in CHF

Modell Modello	Material Materiale	Ventil sFlow, Typ S Piletta sFlow, tipo S	Artikel-Nr. N. di articolo	Beckentiefe Profondità	Exkl. MWST IVA esclusa	Inkl. MWST IVA inclusa	VRG TRA	
Daneo DAN 45IF/12	Edelstahl, matt Acciaio inox, opaco	18/10	3 1/2" TouchFlow	10.104.206.00	175 mm	A 1410.–	1524.–	0.19
			3 1/2" Raumspär Salvaspazio	10.104.207.00	175 mm	A 1212.–	1310.–	
			3 1/2" Tipo	10.104.208.00	175 mm	A 1171.–	1266.–	

Daneo: DAN 45IF/12

Randbreite 12 mm
Larghezza bordo 12 mm

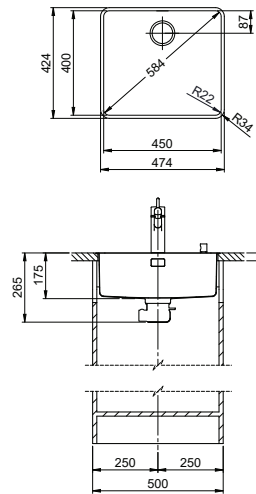
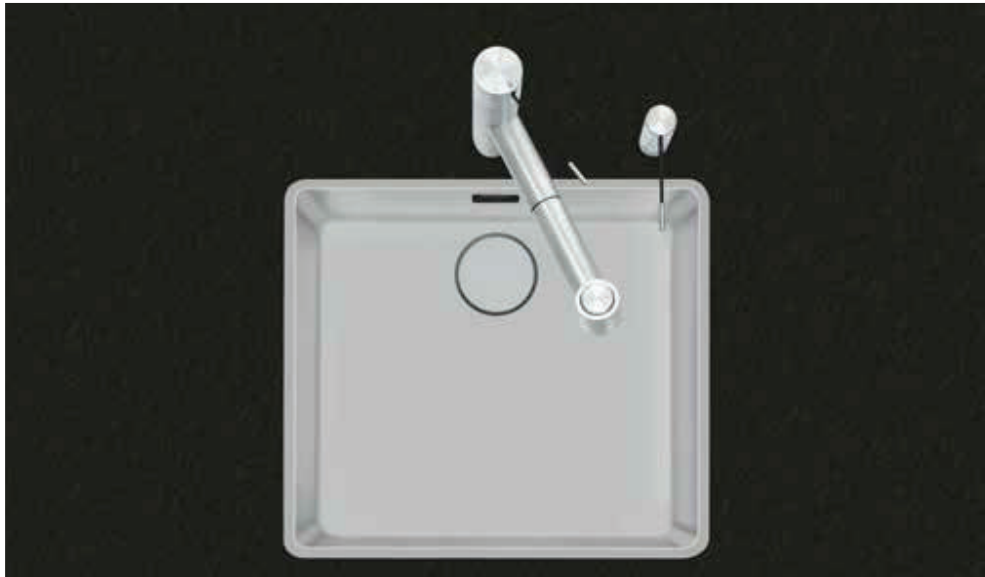

eFlow mit eControl
eFlow con eControl

Schwenkbare Überlaufkappe
Placchetta di troppopieno a ribalta

Desino: Verdeckter Ablauf mit untenliegendem Sieb
Desino: Scarico coperto con griglietta inferiore



Für eFlow Desino
Per eFlow Desino

Für TouchFlow Desino und Raumspar Desino
Per TouchFlow Desino e Salvaspazio Desino

Für eFlow Desino, TouchFlow Desino und Raumspar Desino
Per eFlow Desino, TouchFlow Desino e Salvaspazio Desino

Optionales Zubehör / Accessori opzionali

310



Resteschale gelocht
Vaschetta forata
CHF 106.– 40.000.912.00



Resteschale ungelocht
Vaschetta non forata
CHF 106.– 40.001.289.00

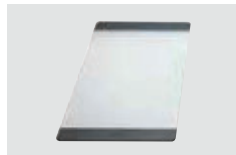

Schneidebrett aus Glas
Tagliere in vetro
CHF 151.– 40.000.909.00



Schneidebrett aus Kunststoff
Tagliere sintetico
CHF 151.– 40.001.277.00

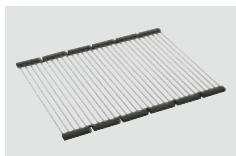

Inox Pad
CHF 125.– 40.001.138.00

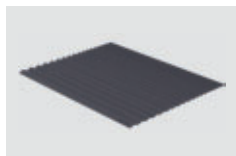

Maro Abtropfmatte aus Silikon
Maro tappetino scolapiatti in silicone
CHF 51.– 40.002.008.00

Zeichnung als pdf / dxf und Montageanleitung siehe:
V. disegno in formato pdf / dxf e montaggio:
suter.ch

Flächenbündiger Einbau: Empfehlung zur Wahl der Arbeitsplatte

Wir empfehlen den Einbau in Arbeitsplatten aus Keramik, Granit, Kunststein (z.B. Corian oder Varicor) oder Massivholz. Vom Einbau in beschichtete Spanplatten raten wir ab.

Montaggio a filo top: Consiglio per la scelta del piano di lavoro

Consigliamo il montaggio nei piani di lavoro in ceramica, granito, pietra artificiale (per es. Corian o Varicor) oppure in legno massiccio. Sconsigliamo la posa in pannelli di truciolato rivestiti.

1 Produktausführung, 2 Montagearten

Der besondere Vorteil von IF-Modellen: Sowohl der flächenbündige Einbau als auch der flach aufliegende Einbau ist möglich.

1 versione di prodotto, 2 metodi di montaggio

I modelli IF presentano un grande vantaggio: possono essere posati sia a filo top che sopra piano.

Varianten: Für die flächenbündige Spüle Daneo mit Standard Zugknopf Advant Chrom bestellen Sie
xx.xxx.xx.01 Standardartikel ohne Zugknopf. Reduktion CHF 24.–. Im Austausch wählen Sie den gewünschten Zugknopf auf Seite 358.
Varianti: per il lavello a filo top Daneo con pomolo standard Advant cromato, ordinate
xx.xxx.xx.01 – Articolo standard senza pomolo. Riduzione di CHF 24.–. In sostituzione, scegliete il pomolo desiderato a pagina 358.

Preis CHF/Prezzo in CHF

Modell Modello	Material Materiale	Ventil sFlow, Typ M Piletta sFlow, tipo M	Artikel-Nr. N. di articolo	Beckentiefe Profondità	Exkl. MWST IVA esclusa	Inkl. MWST IVA inclusa	VRG TRA	
Daneo DAN 45IF/12	Edelstahl, matt Acciaio inox, opaco	18/10	3 1/2" eFlow Desino	10.104.675.00	175 mm	A 1677.–	1813.–	0.19
			3 1/2" TouchFlow Desino	10.104.653.00	175 mm	A 1562.–	1689.–	0.19
			3 1/2" Raumspar Desino Salvaspazio Desino	10.104.654.00	175 mm	A 1352.–	1462.–	

Daneo: DAN 50F/7

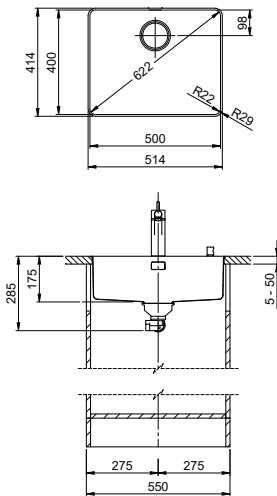
Randbreite 7 mm
Larghezza bordo 7 mm

 Schwenkbare Überlaufkappe
Placchetta di troppopieno a ribalta

 Obenliegendes Sieb
Griglietta superiore

 Zeichnung als pdf / dxf und Montageanleitung siehe:
V. disegno in formato pdf / dxf e montaggio:
suter.ch

Optionales Zubehör / Accessori opzionali

Resteschale gelocht
Vaschetta forata
CHF 106.– 40.000.912.00

Resteschale ungelocht
Vaschetta non forata
CHF 106.– 40.001.289.00

Schneidebrett aus Glas
Tagliere in vetro
CHF 151.– 40.000.909.00

Schneidebrett aus Kunststoff
Tagliere sintetico
CHF 151.– 40.001.277.00

Inox Pad
CHF 125.– 40.001.138.00

Maro Abtropfmatte aus Silikon
Maro tappetino scolapiatti in silicone
CHF 51.– 40.002.008.00

Nur für flächenbündigen Einbau erhältlich.
Disponibile solo per montaggio a filo top.

Flächenbündiger Einbau: Empfehlung zur Wahl der Arbeitsplatte

Wir empfehlen den Einbau in Arbeitsplatten aus Keramik, Granit, Kunststein (z.B. Corian oder Varicor) oder Massivholz. Vom Einbau in beschichtete Spanplatten raten wir ab.

Montaggio a filo top: Consiglio per la scelta del piano di lavoro

Consigliamo il montaggio nei piani di lavoro in ceramica, granito, pietra artificiale (per es. Corian o Varicor) oppure in legno massiccio. Sconsigliamo la posa in pannelli di truciolato rivestiti.

Varianten: Für die flächenbündige Spüle Daneo mit Standard Zugknopf Advant Chrom bestellen Sie
xx.xxx.xx.01 Standardartikel ohne Zugknopf. Reduktion CHF 24.–. Im Austausch wählen Sie den gewünschten Zugknopf auf Seite 358.
Varianti: per il lavello a filo top Daneo con pomolo standard Advant cromato, ordinate
xx.xxx.xx.01 – Articolo standard senza pomolo. Riduzione di CHF 24.–. In sostituzione, scegliete il pomolo desiderato a pagina 358.

Preis CHF/Prezzo in CHF

Modell Modello	Material Materiale	Ventil sFlow, Typ S Piletta sFlow, tipo S	Artikel-Nr. N. di articolo	Beckentiefe Profondità	Exkl. MWST IVA esclusa	Inkl. MWST IVA inclusa	VRG TRA	
Daneo DAN 50F/7	Edelstahl, matt Acciaio inox, opaco	18/10	3 1/2" TouchFlow	10.104.172.00	175 mm	A 1496.–	1617.–	0.19
			3 1/2" Raumspär Salvaspazio	10.104.173.00	175 mm	A 1298.–	1403.–	
			3 1/2" Tipo	10.104.174.00	175 mm	A 1257.–	1359.–	

Daneo: DAN 50F/7

Randbreite 7 mm
Larghezza bordo 7 mm

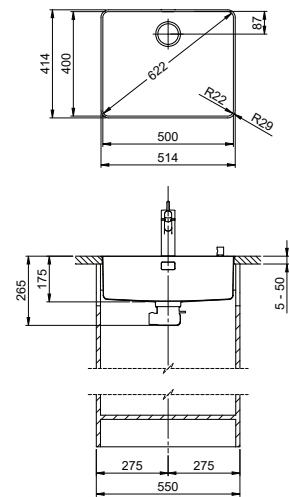

eFlow mit eControl
eFlow con eControl

Schwenkbare Überlaufkappe
Placchetta di troppopieno a ribalta

Desino: Verdeckter Ablauf mit untenliegendem Sieb
Desino: Scarico coperto con griglietta inferiore



Für eFlow Desino
Per eFlow Desino

Für TouchFlow Desino und Raumspars Desino
Per TouchFlow Desino e Salvaspazio Desino

Für eFlow Desino, TouchFlow Desino und Raumspars Desino
Per eFlow Desino, TouchFlow Desino e Salvaspazio Desino

Optionales Zubehör / Accessori opzionali

310

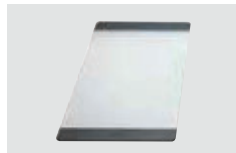

Resteschale gelocht
Vaschetta forata
CHF 106.– 40.000.912.00

Resteschale ungelocht
Vaschetta non forata
CHF 106.– 40.001.289.00

Schneidebrett aus Glas
Tagliere in vetro
CHF 151.– 40.000.909.00

Schneidebrett aus Kunststoff
Tagliere sintetico
CHF 151.– 40.001.277.00

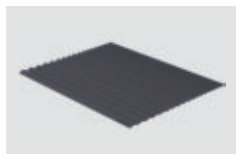
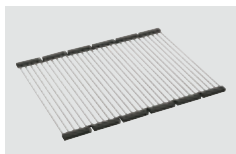

Innox Pad
CHF 125.– 40.001.138.00

Maro Abtropfmatte aus Silikon
Maro tappetino scolapiatti in silicone
CHF 51.– 40.002.008.00

Zeichnung als pdf / dxf und Montageanleitung siehe:
V. disegno in formato pdf / dxf e montaggio:
suter.ch

Nur für flächenbündigen Einbau erhältlich.
Disponibile solo per montaggio a filo top.

Flächenbündiger Einbau: Empfehlung zur Wahl der Arbeitsplatte

Wir empfehlen den Einbau in Arbeitsplatten aus Keramik, Granit, Kunststein (z.B. Corian oder Varicor) oder Massivholz. Vom Einbau in beschichtete Spanplatten raten wir ab.

Montaggio a filo top: Consiglio per la scelta del piano di lavoro

Consigliamo il montaggio nei piani di lavoro in ceramica, granito, pietra artificiale (per es. Corian o Varicor) oppure in legno massiccio. Sconsigliamo la posa in pannelli di truciolato rivestiti.

! Varianten: Für die flächenbündige Spüle Daneo mit Standard Zugknopf Advant Chrom bestellen Sie xx.xxx.xx.01 Standardartikel ohne Zugknopf. Reduktion CHF 24.–. Im Austausch wählen Sie den gewünschten Zugknopf auf Seite 358.
Varianti: per il lavello a filo top Daneo con pomolo standard Advant cromato, ordinate xx.xxx.xx.01 – Articolo standard senza pomolo. Riduzione di CHF 24.–. In sostituzione, scegliete il pomolo desiderato a pagina 358.

Preis CHF/Prezzo in CHF

Modell Modello	Material Materiale	Ventil sFlow, Typ M Piletta sFlow, tipo M	Artikel-Nr. N. di articolo	Beckentiefe Profondità	Exkl. MWST IVA esclusa	Inkl. MWST IVA inclusa	VRG TRA
Daneo DAN 50F/7	Edelstahl, matt Acciaio inox, opaco	18/10	3 1/2" eFlow Desino	10.104.676.00	175 mm	A 1763.–	1906.– 0.19
			3 1/2" TouchFlow Desino	10.104.655.00	175 mm	A 1648.–	1781.– 0.19
			3 1/2" Raumspars Desino Salvaspazio Desino	10.104.656.00	175 mm	A 1438.–	1554.–

Daneo: DAN 50IF/12

Randbreite 12 mm
Larghezza bordo 12 mm

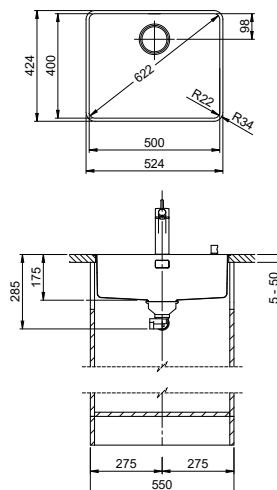

Schwenkbare Überlaufkappe
Placchetta di troppopieno a ribalta

Obenliegendes Sieb
Griglietta superiore

26



Zeichnung als pdf / dxf und Montageanleitung siehe:
V. disegno in formato pdf / dxf e montaggio:
suter.ch

Optionales Zubehör / Accessori opzionali

310

Resteschale gelocht Vaschetta forato CHF 106.– 40.000.912.00	Resteschale ungelocht Vaschetta non forato CHF 106.– 40.001.289.00	Schneidebrett aus Glas Tagliere in vetro CHF 151.– 40.000.909.00	Schneidebrett aus Kunststoff Tagliere sintetico CHF 151.– 40.001.277.00
Inox Pad CHF 125.– 40.001.138.00	Maro Abtropfmatte aus Silikon Maro tappetino scolapiatti in silicone CHF 51.– 40.002.008.00		

Flächenbündiger Einbau: Empfehlung zur Wahl der Arbeitsplatte

Wir empfehlen den Einbau in Arbeitsplatten aus Keramik, Granit, Kunststein (z.B. Corian oder Varicor) oder Massivholz. Vom Einbau in beschichtete Spanplatten raten wir ab.

Montaggio a filo top: Consiglio per la scelta del piano di lavoro

Consigliamo il montaggio nei piani di lavoro in ceramica, granito, pietra artificiale (per es. Corian o Varicor) oppure in legno massiccio. Sconsigliamo la posa in pannelli di truciolato rivestiti.

1 Produktausführung, 2 Montagearten

Der besondere Vorteil von IF-Modellen: Sowohl der flächenbündige Einbau als auch der flach aufliegende Einbau ist möglich.

1 versione di prodotto, 2 metodi di montaggio

I modelli IF presentano un grande vantaggio: possono essere posati sia a filo top che sopra piano.

Varianten: Für die flächenbündige Spüle Daneo mit Standard Zugknopf Advant Chrom bestellen Sie
xx.xxx.xx.01 Standardartikel ohne Zugknopf. Reduktion CHF 24.–. Im Austausch wählen Sie den gewünschten Zugknopf auf Seite 358.
Varianti: per il lavello a filo top Daneo con pomolo standard Advant cromato, ordinate
xx.xxx.xx.01 – Articolo standard senza pomolo. Riduzione di CHF 24.–. In sostituzione, scegliete il pomolo desiderato a pagina 358.

Preis CHF/Prezzo in CHF

Modell Modello	Material Materiale	Ventil sFlow, Typ S Piletta sFlow, tipo S	Artikel-Nr. N. di articolo	Beckentiefe Profondità	Exkl. MWST IVA esclusa	Inkl. MWST IVA inclusa	VRG TRA	
Daneo DAN 50IF/12	Edelstahl, matt Acciaio inox, opaco	18/10	3 1/2" TouchFlow	10.104.209.00	175 mm	A 1434.–	1550.–	0.19
			3 1/2" Raumspär Salvaspazio	10.104.210.00	175 mm	A 1236.–	1336.–	
			3 1/2" Tipo	10.104.211.00	175 mm	A 1195.–	1292.–	

Daneo: DAN 50IF/12

Randbreite 12 mm
Larghezza bordo 12 mm

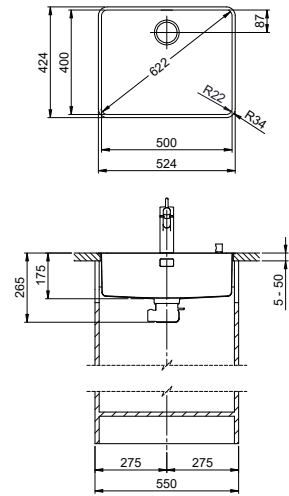

eFlow mit eControl
eFlow con eControl

Schwenkbare Überlaufkappe
Placchetta di troppopieno a ribalta

Desino: Verdeckter Ablauf mit untenliegendem Sieb
Desino: Scarico coperto con griglietta inferiore



Für eFlow Desino
Per eFlow Desino

Für TouchFlow Desino und Raumspars Desino
Per TouchFlow Desino e Salvaspazio Desino

Für eFlow Desino, TouchFlow Desino und Raumspars Desino
Per eFlow Desino, TouchFlow Desino e Salvaspazio Desino

Optionales Zubehör / Accessori opzionali

310



Resteschale gelocht
Vaschetta forata
CHF 106.– 40.000.912.00



Resteschale ungelocht
Vaschetta non forata
CHF 106.– 40.001.289.00

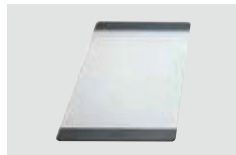

Schneidebrett aus Glas
Tagliere in vetro
CHF 151.– 40.000.909.00



Schneidebrett aus Kunststoff
Tagliere sintetico
CHF 151.– 40.001.277.00

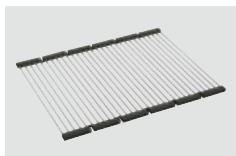

Inox Pad
CHF 125.– 40.001.138.00

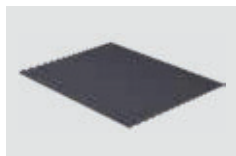

Maro Abtropfmatte aus Silikon
Maro tappetino scolapiatti in silicone
CHF 51.– 40.002.008.00

Zeichnung als pdf / dxf und Montageanleitung siehe:
V. disegno in formato pdf / dxf e montaggio:
suter.ch

Flächenbündiger Einbau: Empfehlung zur Wahl der Arbeitsplatte

Wir empfehlen den Einbau in Arbeitsplatten aus Keramik, Granit, Kunststein (z.B. Corian oder Varicor) oder Massivholz. Vom Einbau in beschichtete Spanplatten raten wir ab.

Montaggio a filo top: Consiglio per la scelta del piano di lavoro

Consigliamo il montaggio nei piani di lavoro in ceramica, granito, pietra artificiale (per es. Corian o Varicor) oppure in legno massiccio. Sconsigliamo la posa in pannelli di truciolato rivestiti.

1 Produktausführung, 2 Montagearten

Der besondere Vorteil von IF-Modellen: Sowohl der flächenbündige Einbau als auch der flach aufliegende Einbau ist möglich.

1 versione di prodotto, 2 metodi di montaggio

I modelli IF presentano un grande vantaggio: possono essere posati sia a filo top che sopra piano.

Varianten: Für die flächenbündige Spüle Daneo mit Standard Zugknopf Advant Chrom bestellen Sie
xx.xxx.xx.01 Standardartikel ohne Zugknopf. Reduktion CHF 24.–. Im Austausch wählen Sie den gewünschten Zugknopf auf Seite 358.
Varianti: per il lavello a filo top Daneo con pomolo standard Advant cromato, ordinate
xx.xxx.xx.01 – Articolo standard senza pomolo. Riduzione di CHF 24.–. In sostituzione, scegliete il pomolo desiderato a pagina 358.

Preis CHF/Prezzo in CHF

Modell Modello	Material Materiale	Ventil sFlow, Typ M Piletta sFlow, tipo M	Artikel-Nr. N. di articolo	Beckentiefe Profondità	Exkl. MWST IVA esclusa	Inkl. MWST IVA inclusa	VRG TRA
Daneo DAN 50IF/12	Edelstahl, matt Acciaio inox, opaco	18/10	3 1/2" eFlow Desino	10.104.677.00	175 mm	A 1701.–	1839.– 0.19
			3 1/2" TouchFlow Desino	10.104.657.00	175 mm	A 1586.–	1714.– 0.19
			3 1/2" Raumspars Desino Salvaspazio Desino	10.104.658.00	175 mm	A 1376.–	1487.–

Daneo: DAN 55F/7

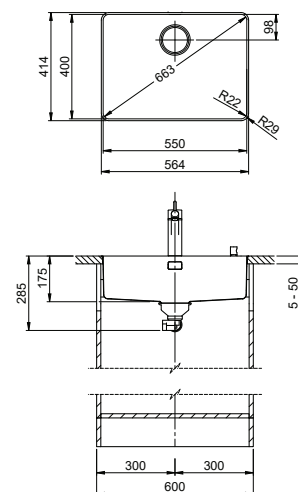
Randbreite 7 mm
Larghezza bordo 7 mm

 Schwenkbare Überlaufkappe
Placchetta di troppopieno a ribalta

27

 Obenliegendes Sieb
Griglietta superiore

26

 Zeichnung als pdf / dxf und Montageanleitung siehe:
V. disegno in formato pdf / dxf e montaggio:
suter.ch

Optionales Zubehör / Accessori opzionali

310

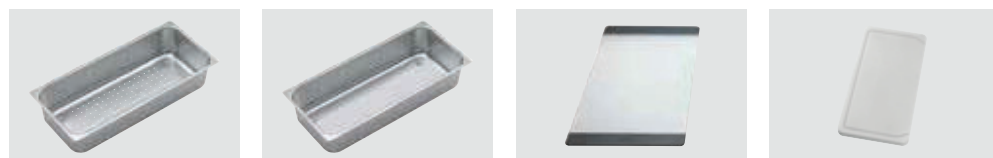
Resteschale gelocht
Vaschetta forata
CHF 106.– 40.000.912.00

Resteschale ungelocht
Vaschetta non forata
CHF 106.– 40.001.289.00

Schneidebrett aus Glas
Tagliere in vetro
CHF 151.– 40.000.909.00

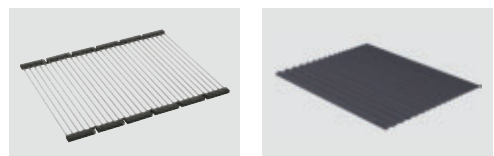
Schneidebrett aus Kunststoff
Tagliere sintetico
CHF 151.– 40.001.277.00

Inox Pad
CHF 125.– 40.001.138.00

Maro Abtropfmatte aus Silikon
Maro tappetino scolapiatti in silicone
CHF 51.– 40.002.008.00

Nur für flächenbündigen Einbau erhältlich.
Disponibile solo per montaggio a filo top.

Flächenbündiger Einbau: Empfehlung zur Wahl der Arbeitsplatte

Wir empfehlen den Einbau in Arbeitsplatten aus Keramik, Granit, Kunststein (z.B. Corian oder Varicor) oder Massivholz. Vom Einbau in beschichtete Spanplatten raten wir ab.

Montaggio a filo top: Consiglio per la scelta del piano di lavoro

Consigliamo il montaggio nei piani di lavoro in ceramica, granito, pietra artificiale (per es. Corian o Varicor) oppure in legno massiccio. Sconsigliamo la posa in pannelli di truciolato rivestiti.

Varianten: Für die flächenbündige Spüle Daneo mit Standard Zugknopf Advant Chrom bestellen Sie
xx.xxx.xx.01 Standardartikel ohne Zugknopf. Reduktion CHF 24.–. Im Austausch wählen Sie den gewünschten Zugknopf auf Seite 358.
Varianti: per il lavello a filo top Daneo con pomolo standard Advant cromato, ordinate
xx.xxx.xx.01 – Articolo standard senza pomolo. Riduzione di CHF 24.–. In sostituzione, scegliete il pomolo desiderato a pagina 358.

Preis CHF / Prezzo in CHF

Modell Modello	Material Materiale	Ventil sFlow, Typ S Piletta sFlow, tipo S	Artikel-Nr. N. di articolo	Beckentiefe Profondità	Exkl. MWST IVA esclusa	Inkl. MWST IVA inclusa	VRG TRA		
Daneo DAN 55F/7	Edelstahl, matt Acciaio inox, opaco	18/10	3 1/2" TouchFlow	10.104.175.00	175 mm	A	1587.–	1716.–	0.19
			3 1/2" Raumspär Salvaspazio	10.104.176.00	175 mm	A	1389.–	1502.–	
			3 1/2" Tipo	10.104.177.00	175 mm	A	1348.–	1457.–	

Daneo: DAN 55F/7

Randbreite 7 mm
Larghezza bordo 7 mm

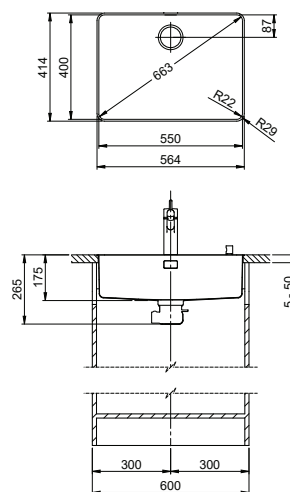

eFlow mit eControl
eFlow con eControl

Schwenkbare Überlaufkappe
Placchetta di troppopieno a ribalta

Desino: Verdeckter Ablauf mit untenliegendem Sieb
Desino: Scarico coperto con griglietta inferiore



Für eFlow Desino
Per eFlow Desino



Für TouchFlow Desino und Raumspär Desino
Per TouchFlow Desino e Salvaspazio Desino



Für eFlow Desino, TouchFlow Desino und Raumspär Desino
Per eFlow Desino, TouchFlow Desino e Salvaspazio Desino



Optionales Zubehör / Accessori opzionali

310



Resteschale gelocht
Vaschetta forato
CHF 106.– 40.000.912.00



Resteschale ungelocht
Vaschetta non forato
CHF 106.– 40.001.289.00

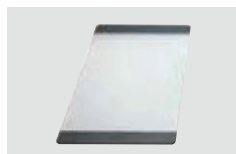

Schneidebrett aus Glas
Tagliere in vetro
CHF 151.– 40.000.909.00



Schneidebrett aus Kunststoff
Tagliere sintetico
CHF 151.– 40.001.277.00

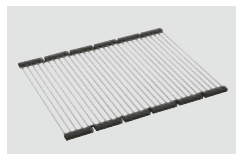

Inox Pad
CHF 125.– 40.001.138.00

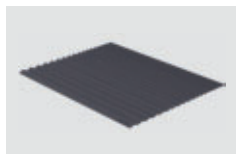

Maro Abtropfmatte aus Silikon
Maro tappetino scolapiatti in silicone
CHF 51.– 40.002.008.00

Zeichnung als pdf / dxf und Montageanleitung siehe:
V. disegno in formato pdf / dxf e montaggio:
suter.ch

Nur für flächenbündigen Einbau erhältlich.
Disponibile solo per montaggio a filo top.

Flächenbündiger Einbau: Empfehlung zur Wahl der Arbeitsplatte

Wir empfehlen den Einbau in Arbeitsplatten aus Keramik, Granit, Kunststein (z.B. Corian oder Varicor) oder Massivholz. Vom Einbau in beschichtete Spanplatten raten wir ab.

Montaggio a filo top: Consiglio per la scelta del piano di lavoro

Consigliamo il montaggio nei piani di lavoro in ceramica, granito, pietra artificiale (per es. Corian o Varicor) oppure in legno massiccio. Sconsigliamo la posa in pannelli di truciolato rivestiti.

Varianten: Für die flächenbündige Spüle Daneo mit Standard Zugknopf Advant Chrom bestellen Sie
xx.xxx.xx.01 Standardartikel ohne Zugknopf. Reduktion CHF 24.–. Im Austausch wählen Sie den gewünschten Zugknopf auf Seite 358.
Varianti: per il lavello a filo top Daneo con pomolo standard Advant cromato, ordinate
xx.xxx.xx.01 – Articolo standard senza pomolo. Riduzione di CHF 24.–. In sostituzione, scegliete il pomolo desiderato a pagina 358.

Preis CHF/Prezzo in CHF

Modell Modello	Material Materiale	Ventil sFlow, Typ M Piletta sFlow, tipo M	Artikel-Nr. N. di articolo	Beckentiefe Profondità	Exkl. MWST IVA esclusa	Inkl. MWST IVA inclusa	VRG TRA
Daneo DAN 55F/7	Edelstahl, matt Acciaio inox, opaco	18/10	3 1/2" eFlow Desino	10.104.678.00	175 mm	A 1854.–	2004.– 0.19
			3 1/2" TouchFlow Desino	10.104.659.00	175 mm	A 1739.–	1880.– 0.19
			3 1/2" Raumspär Desino Salvaspazio Desino	10.104.660.00	175 mm	A 1529.–	1653.–

Daneo: DAN 55IF/12

Randbreite 12 mm
Larghezza bordo 12 mm

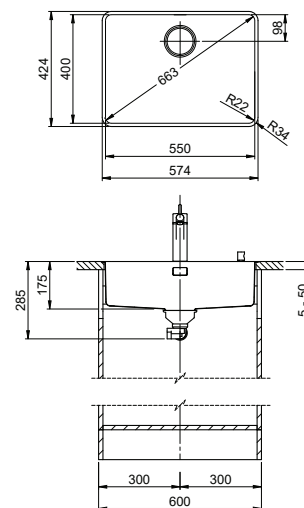

Schwenkbare Überlaufkappe
Placchetta di troppopieno a ribalta

Obenliegendes Sieb
Griglietta superiore

26



Zeichnung als pdf / dxf und Montageanleitung siehe:
V. disegno in formato pdf / dxf e montaggio:
suter.ch

Optionales Zubehör / Accessori opzionali

310

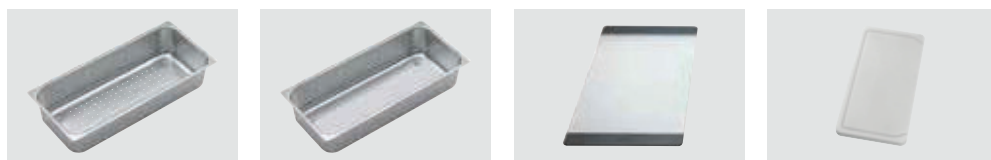

Resteschale gelocht
Vaschetta forata
CHF 106.– 40.000.912.00

Resteschale ungelocht
Vaschetta non forata
CHF 106.– 40.001.289.00

Schneidebrett aus Glas
Tagliere in vetro
CHF 151.– 40.000.909.00

Schneidebrett aus Kunststoff
Tagliere sintetico
CHF 151.– 40.001.277.00

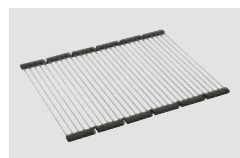

Innox Pad
CHF 125.– 40.001.138.00

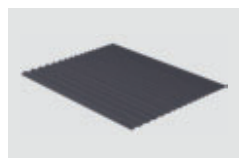

Maro Abtropfmatte aus Silikon
Maro tappetino scolapiatti in silicone
CHF 51.– 40.002.008.00

Flächenbündiger Einbau: Empfehlung zur Wahl der Arbeitsplatte

Wir empfehlen den Einbau in Arbeitsplatten aus Keramik, Granit, Kunststein (z.B. Corian oder Varicor) oder Massivholz. Vom Einbau in beschichtete Spanplatten raten wir ab.

Montaggio a filo top: Consiglio per la scelta del piano di lavoro

Consigliamo il montaggio nei piani di lavoro in ceramica, granito, pietra artificiale (per es. Corian o Varicor) oppure in legno massiccio. Sconsigliamo la posa in pannelli di truciolato rivestiti.

1 Produktausführung, 2 Montagearten

Der besondere Vorteil von IF-Modellen: Sowohl der flächenbündige Einbau als auch der flach aufliegende Einbau ist möglich.

1 versione di prodotto, 2 metodi di montaggio

I modelli IF presentano un grande vantaggio: possono essere posati sia a filo top che sopra piano.

Varianten: Für die flächenbündige Spüle Daneo mit Standard Zugknopf Advant Chrom bestellen Sie
xx.xxx.xx.01 Standardartikel ohne Zugknopf. Reduktion CHF 24.–. Im Austausch wählen Sie den gewünschten Zugknopf auf Seite 358.
Varianti: per il lavello a filo top Daneo con pomolo standard Advant cromato, ordinate
xx.xxx.xx.01 – Articolo standard senza pomolo. Riduzione di CHF 24.–. In sostituzione, scegliete il pomolo desiderato a pagina 358.

Preis CHF/Prezzo in CHF

Modell Modello	Material Materiale	Ventil sFlow, Typ S Piletta sFlow, tipo S	Artikel-Nr. N. di articolo	Beckentiefe Profondità	Exkl. MWST IVA esclusa	Inkl. MWST IVA inclusa	VRG TRA	
Daneo DAN 55IF/12	Edelstahl, matt Acciaio inox, opaco	18/10	3 1/2" TouchFlow	10.104.212.00	175 mm	A 1521.–	1644.–	0.19
			3 1/2" Raumspaar Salvaspazio	10.104.213.00	175 mm	A 1323.–	1430.–	
			3 1/2" Tipo	10.104.214.00	175 mm	A 1282.–	1386.–	

Daneo: DAN 55IF/12

Randbreite 12 mm
Larghezza bordo 12 mm

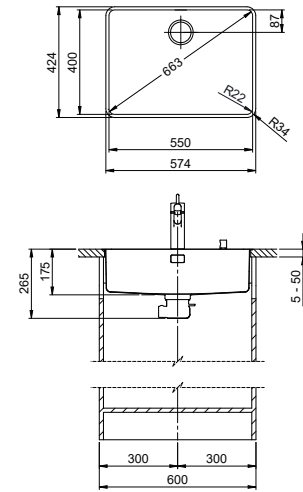

eFlow mit eControl
eFlow con eControl

Schwenkbare Überlaufkappe
Placchetta di troppopieno a ribalta

Desino: Verdeckter Ablauf mit untenliegendem Sieb
Desino: Scarico coperto con griglietta inferiore



Für eFlow Desino
Per eFlow Desino



Für TouchFlow Desino und Raumspars Desino
Per TouchFlow Desino e Salvaspazio Desino



Für eFlow Desino, TouchFlow Desino und Raumspars Desino
Per eFlow Desino, TouchFlow Desino e Salvaspazio Desino



Optionales Zubehör / Accessori opzionali

310



Resteschale gelocht
Vaschetta forata
CHF 106.– 40.000.912.00



Resteschale ungelocht
Vaschetta non forata
CHF 106.– 40.001.289.00

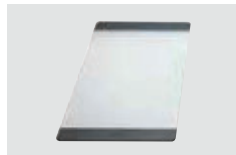

Schneidebrett aus Glas
Tagliere in vetro
CHF 151.– 40.000.909.00



Schneidebrett aus Kunststoff
Tagliere sintetico
CHF 151.– 40.001.277.00

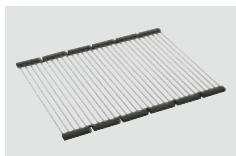

Inox Pad
CHF 125.– 40.001.138.00

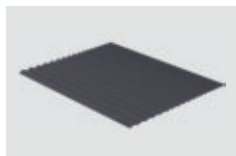

Maro Abtropfmatte aus Silikon
Maro tappetino scolapiatti in silicone
CHF 51.– 40.002.008.00

Zeichnung als pdf / dxf und Montageanleitung siehe:
V. disegno in formato pdf / dxf e montaggio:
suter.ch

Flächenbündiger Einbau: Empfehlung zur Wahl der Arbeitsplatte

Wir empfehlen den Einbau in Arbeitsplatten aus Keramik, Granit, Kunststein (z.B. Corian oder Varicor) oder Massivholz. Vom Einbau in beschichtete Spanplatten raten wir ab.

Montaggio a filo top: Consiglio per la scelta del piano di lavoro

Consigliamo il montaggio nei piani di lavoro in ceramica, granito, pietra artificiale (per es. Corian o Varicor) oppure in legno massiccio. Sconsigliamo la posa in pannelli di truciolato rivestiti.

1 Produktausführung, 2 Montagearten

Der besondere Vorteil von IF-Modellen: Sowohl der flächenbündige Einbau als auch der flach aufliegende Einbau ist möglich.

1 versione di prodotto, 2 metodi di montaggio

I modelli IF presentano un grande vantaggio: possono essere posati sia a filo top che sopra piano.

Varianten: Für die flächenbündige Spüle Daneo mit Standard Zugknopf Advant Chrom bestellen Sie
xx.xxx.xx.01 Standardartikel ohne Zugknopf. Reduktion CHF 24.–. Im Austausch wählen Sie den gewünschten Zugknopf auf Seite 358.
Varianti: per il lavello a filo top Daneo con pomolo standard Advant cromato, ordinate
xx.xxx.xx.01 – Articolo standard senza pomolo. Riduzione di CHF 24.–. In sostituzione, scegliete il pomolo desiderato a pagina 358.

Preis CHF/Prezzo in CHF

Modell Modello	Material Materiale	Ventil sFlow, Typ M Piletta sFlow, tipo M	Artikel-Nr. N. di articolo	Beckentiefe Profondità	Exkl. MWST IVA esclusa	Inkl. MWST IVA inclusa	VRG TRA
Daneo DAN 55IF/12	Edelstahl, matt Acciaio inox, opaco	18/10	3 1/2" eFlow Desino	10.104.679.00	175 mm	A 1788.–	1933.– 0.19
			3 1/2" TouchFlow Desino	10.104.661.00	175 mm	A 1673.–	1809.– 0.19
			3 1/2" Raumspars Desino Salvaspazio Desino	10.104.662.00	175 mm	A 1463.–	1582.–

Daneo: DAN 100-50IF

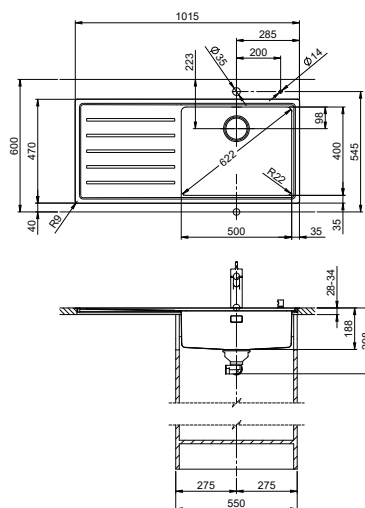

Schwenkbare Überlaufkappe
Placchetta di troppopieno a ribalta

Obenliegendes Sieb
Griglietta superiore

26



Zeichnung als pdf / dxf und Montageanleitung siehe:
V. disegno in formato pdf / dxf e montaggio:
suter.ch

Optionales Zubehör / Accessori opzionali

310

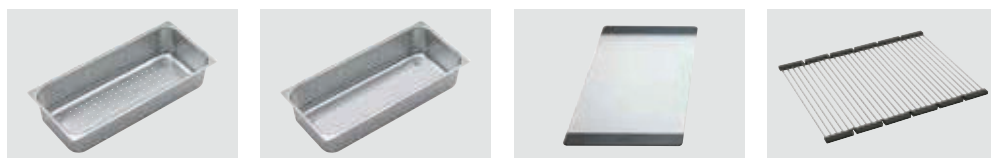

Resteschale gelocht
Vaschetta forato
CHF 106.– 40.000.912.00

Resteschale ungelocht
Vaschetta non forato
CHF 106.– 40.001.289.00

Schneidebrett aus Glas
Tagliere in vetro
CHF 151.– 40.000.909.00

Inox Pad
CHF 125.– 40.001.140.00

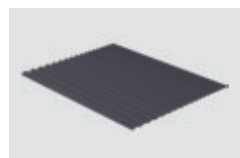

Maro Abtropfmatte aus Silikon
Maro tappetino scolapiatti in silicone
CHF 51.– 40.002.008.00

Flächenbündiger Einbau: Empfehlung zur Wahl der Arbeitsplatte

Wir empfehlen den Einbau in Arbeitsplatten aus Keramik, Granit, Kunststein (z.B. Corian oder Varicor) oder Massivholz. Vom Einbau in beschichtete Spanplatten raten wir ab.

Montaggio a filo top: Consiglio per la scelta del piano di lavoro

Consigliamo il montaggio nei piani di lavoro in ceramica, granito, pietra artificiale (per es. Corian o Varicor) oppure in legno massiccio. Sconsigliamo la posa in pannelli di truciolato rivestiti.

1 Produktausführung, 2 Montagearten

Der besondere Vorteil von IF-Modellen: Sowohl der flächenbündige Einbau als auch der flach aufliegende Einbau ist möglich.

1 versione di prodotto, 2 metodi di montaggio

I modelli IF presentano un grande vantaggio: possono essere posati sia a filo top che sopra piano.

Varianten: Für die flächenbündige Spüle Daneo mit Standard Zugknopf Advant Chrom bestellen Sie
xx.xxx.xx.01 Standardartikel ohne Zugknopf. Reduktion CHF 24.–. Im Austausch wählen Sie den gewünschten Zugknopf auf Seite 358.
Varianti: per il lavello a filo top Daneo con pomolo standard Advant cromato, ordinate
xx.xxx.xx.01 – Articolo standard senza pomolo. Riduzione di CHF 24.–. In sostituzione, scegliete il pomolo desiderato a pagina 358.

Preis CHF / Prezzo in CHF

Modell Modello	Material Materiale	Ventil Piletta	Artikel-Nr. N. di articolo	Tropfteil Scolatoio	Exkl. MWST IVA esclusa	Inkl. MWST IVA inclusa	VRG TRA	
Daneo DAN 100-50IF	Edelstahl, matt Acciaio inox, opaco	3 1/2" TouchFlow	10.103.588.00	Links / Sinistra	A	2233.–	2414.–	0.19
			10.103.591.00	Rechts / Destra				
		3 1/2" Raumspaar Salvaspazio	10.103.589.00	Links / Sinistra	A	2035.–	2200.–	
			10.103.592.00	Rechts / Destra				
		3 1/2" Tipo	10.103.590.00	Links / Sinistra	A	1994.–	2156.–	
			10.103.593.00	Rechts / Destra				

Daneo: DAN 100-50IF EL

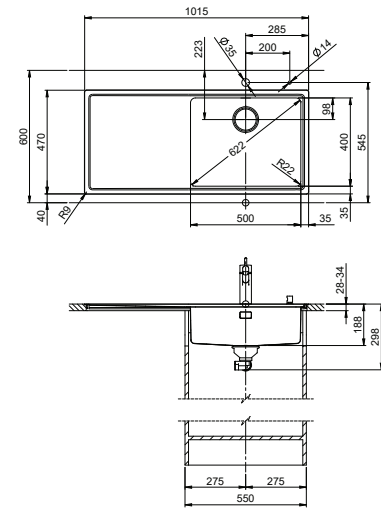

Schwenkbare Überlaufkappe
Placchetta di troppopieno a ribalta

Obenliegendes Sieb
Griglietta superiore

26



Zeichnung als pdf / dxf und Montageanleitung siehe:
V. disegno in formato pdf / dxf e montaggio:
suter.ch

Optionales Zubehör / Accessori opzionali

310

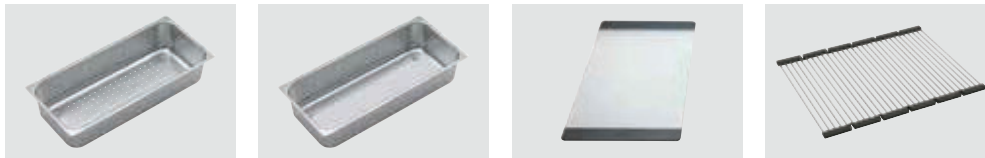

Resteschale gelocht
Vaschetta forato
CHF 106.– 40.000.912.00

Resteschale ungelocht
Vaschetta non forato
CHF 106.– 40.001.289.00

Schneidebrett aus Glas
Tagliere in vetro
CHF 151.– 40.000.909.00

Inox Pad
CHF 125.– 40.001.140.00

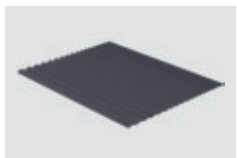

Maro Abtropfmatte aus Silikon
Maro tappetino scolapiatti in silicone
CHF 51.– 40.002.008.00

Flächenbündiger Einbau: Empfehlung zur Wahl der Arbeitsplatte

Wir empfehlen den Einbau in Arbeitsplatten aus Keramik, Granit, Kunststein (z.B. Corian oder Varicor) oder Massivholz. Vom Einbau in beschichtete Spanplatten raten wir ab.

Montaggio a filo top: Consiglio per la scelta del piano di lavoro

Consigliamo il montaggio nei piani di lavoro in ceramica, granito, pietra artificiale (per es. Corian o Varicor) oppure in legno massiccio. Sconsigliamo la posa in pannelli di truciolato rivestiti.

1 Produktausführung, 2 Montagearten

Der besondere Vorteil von IF-Modellen: Sowohl der flächenbündige Einbau als auch der flach aufliegende Einbau ist möglich.

1 versione di prodotto, 2 metodi di montaggio

I modelli IF presentano un grande vantaggio: possono essere posati sia a filo top che sopra piano.

! Varianten: Für die flächenbündige Spüle Daneo mit Standard Zugknopf Advant Chrom bestellen Sie
xx.xxx.xx.01 Standardartikel ohne Zugknopf. Reduktion CHF 24.–. Im Austausch wählen Sie den gewünschten Zugknopf auf Seite 358.
Varianti: per il lavello a filo top Daneo con pomolo standard Advant cromato, ordinate
xx.xxx.xx.01 – Articolo standard senza pomolo. Riduzione di CHF 24.–. In sostituzione, scegliete il pomolo desiderato a pagina 358.

Preis CHF/Prezzo in CHF

Modell Modello	Material Materiale	Ventil Piletta	Artikel-Nr. N. di articolo	Tropfteil Scolatoio	Exkl. MWST IVA esclusa	Inkl. MWST IVA inclusa	VRG TRA	
Daneo DAN 100-50IF EL	Edelstahl, matt Acciaio inox, opaco	18/10	3 1/2" TouchFlow	Links / Sinistra	A	2233.–	2414.–	0.19
				Rechts / Destra				
			3 1/2" Raumspaar Salvaspazio	Links / Sinistra	A	2035.–	2200.–	
				Rechts / Destra				
			3 1/2" Tipo	Links / Sinistra	A	1994.–	2156.–	
				Rechts / Destra				

Daneo: DAN 100-55IF

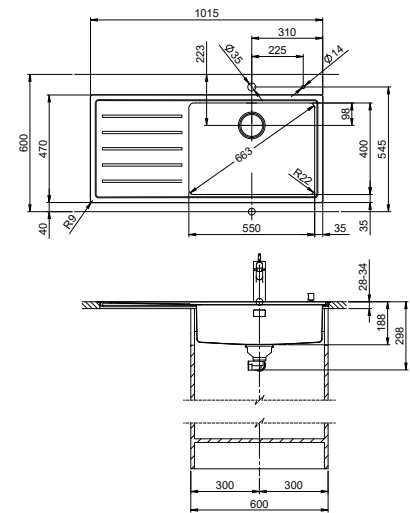

Schwenkbare Überlaufkappe
Placchetta di troppopieno a ribalta

Obenliegendes Sieb
Griglietta superiore

26



Zeichnung als pdf / dxf und Montageanleitung siehe:
V. disegno in formato pdf / dxf e montaggio:
suter.ch

Optionales Zubehör / Accessori opzionali

310

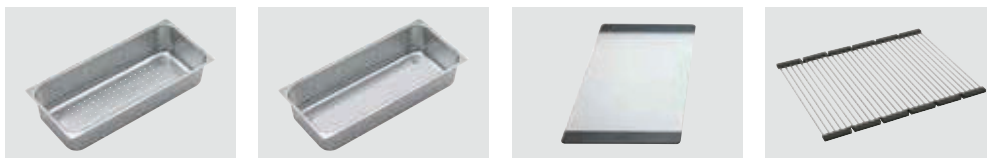

Resteschale gelocht
Vaschetta forato
CHF 106.– 40.000.912.00

Resteschale ungelocht
Vaschetta non forato
CHF 106.– 40.001.289.00

Schneidebrett aus Glas
Tagliere in vetro
CHF 151.– 40.000.909.00

Inox Pad
CHF 125.– 40.001.140.00

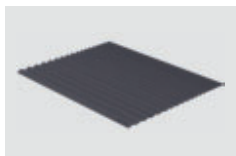

Maro Abtropfmatte aus Silikon
Maro tappetino scolapiatti in silicone
CHF 51.– 40.002.008.00

Flächenbündiger Einbau: Empfehlung zur Wahl der Arbeitsplatte
Wir empfehlen den Einbau in Arbeitsplatten aus Keramik, Granit, Kunststein (z.B. Corian oder Varicor) oder Massivholz. Vom Einbau in beschichtete Spanplatten raten wir ab.

Montaggio a filo top: Consiglio per la scelta del piano di lavoro
Consigliamo il montaggio nei piani di lavoro in ceramica, granito, pietra artificiale (per es. Corian o Varicor) oppure in legno massiccio. Sconsigliamo la posa in pannelli di truciolato rivestiti.

1 Produktausführung, 2 Montagearten
Der besondere Vorteil von IF-Modellen: Sowohl der flächenbündige Einbau als auch der flach aufliegende Einbau ist möglich.

1 versione di prodotto, 2 metodi di montaggio
I modelli IF presentano un grande vantaggio: possono essere posati sia a filo top che sopra piano.

! Varianten: Für die flächenbündige Spüle Daneo mit Standard Zugknopf Advant Chrom bestellen Sie
xx.xxx.xx.01 Standardartikel ohne Zugknopf. Reduktion CHF 24.–. Im Austausch wählen Sie den gewünschten Zugknopf auf Seite 358.
Varianti: per il lavello a filo top Daneo con pomolo standard Advant cromato, ordinate
xx.xxx.xx.01 – Articolo standard senza pomolo. Riduzione di CHF 24.–. In sostituzione, scegliete il pomolo desiderato a pagina 358.

Preis CHF / Prezzo in CHF

Modell Modello	Material Materiale	Ventil Piletta	Artikel-Nr. N. di articolo	Tropfteil Scolatoio	Exkl. MWST IVA esclusa	Inkl. MWST IVA inclusa	VRG TRA
Daneo DAN 100-55IF	Edelstahl, matt Acciaio inox, opaco	3 1/2" TouchFlow	10.103.974.00	Links / Sinistra	A	2343.–	2533.–
			10.103.975.00	Rechts / Destra			
		3 1/2" Raumspaar Salvaspazio	10.103.985.00	Links / Sinistra	A	2145.–	2319.–
			10.103.986.00	Rechts / Destra			
		3 1/2" Tipo	10.103.976.00	Links / Sinistra	A	2104.–	2274.–
			10.103.977.00	Rechts / Destra			

Daneo: DAN 110-50IF

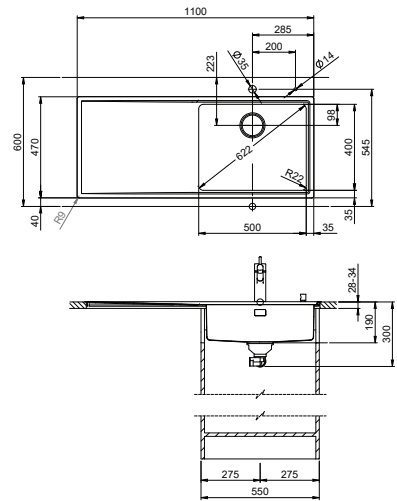

Schwenkbare Überlaufkappe
Placchetta di troppopieno a ribalta

Obenliegendes Sieb
Griglietta superiore

26



Zeichnung als pdf / dxf und Montageanleitung siehe:
V. disegno in formato pdf / dxf e montaggio:
suter.ch

Optionales Zubehör / Accessori opzionali

310

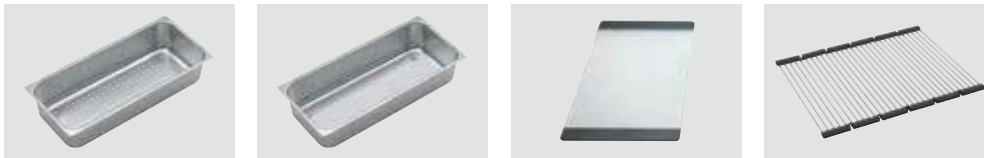

Resteschale gelocht
Vaschetta forato
CHF 106.– 40.000.912.00

Resteschale ungelocht
Vaschetta non forato
CHF 106.– 40.001.289.00

Schneidebrett aus Glas
Tagliere in vetro
CHF 151.– 40.000.909.00

Inox Pad
CHF 125.– 40.001.140.00

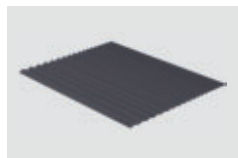

Maro Abtropfmatte aus Silikon
Maro tappetino scolapiatti in silicone
CHF 51.– 40.002.008.00

Flächenbündiger Einbau: Empfehlung zur Wahl der Arbeitsplatte
Wir empfehlen den Einbau in Arbeitsplatten aus Keramik, Granit, Kunststein (z.B. Corian oder Varicor) oder Massivholz. Vom Einbau in beschichtete Spanplatten raten wir ab.

Montaggio a filo top: Consiglio per la scelta del piano di lavoro
Consigliamo il montaggio nei piani di lavoro in ceramica, granito, pietra artificiale (per es. Corian o Varicor) oppure in legno massiccio. Sconsigliamo la posa in pannelli di truciolato rivestiti.

1 Produktausführung, 2 Montagearten
Der besondere Vorteil von IF-Modellen: Sowohl der flächenbündige Einbau als auch der flach aufliegende Einbau ist möglich.

1 versione di prodotto, 2 metodi di montaggio
I modelli IF presentano un grande vantaggio: possono essere posati sia a filo top che sopra piano.

! Varianten: Für die flächenbündige Spüle Daneo mit Standard Zugknopf Advant Chrom bestellen Sie
xx.xxx.xx.01 Standardartikel ohne Zugknopf. Reduktion CHF 24.–. Im Austausch wählen Sie den gewünschten Zugknopf auf Seite 358.
Varianti: per il lavello a filo top Daneo con pomolo standard Advant cromato, ordinate
xx.xxx.xx.01 – Articolo standard senza pomolo. Riduzione di CHF 24.–. In sostituzione, scegliete il pomolo desiderato a pagina 358.

Preis CHF / Prezzo in CHF

Modell Modello	Material Materiale	Ventil Piletta	Artikel-Nr. N. di articolo	Tropfteil Scolatoio	Exkl. MWST IVA esclusa	Inkl. MWST IVA inclusa	VRG TRA
Daneo DAN 110-50IF	Edelstahl, matt Acciaio inox, opaco 18/10	3 1/2" TouchFlow	10.103.962.00	Links / Sinistra	A 2303.–	2490.–	0.19
			10.103.963.00	Rechts / Destra			
		3 1/2" Raumspaar Salvaspazio	10.103.981.00	Links / Sinistra	A 2105.–	2276.–	
			10.103.982.00	Rechts / Destra			
		3 1/2" Tipo	10.103.964.00	Links / Sinistra	A 2064.–	2231.–	
			10.103.965.00	Rechts / Destra			

Daneo: DAN 110-55IF

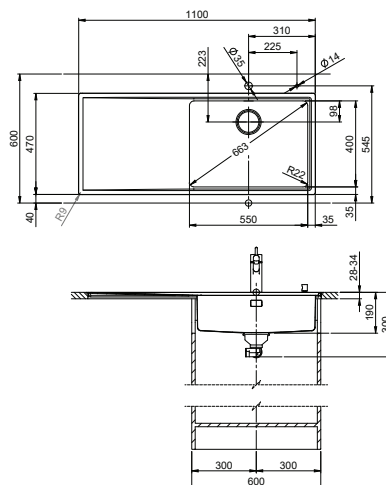

Schwenkbare Überlaufkappe
Placchetta di troppopieno a ribalta

Obenliegendes Sieb
Griglietta superiore

26



Zeichnung als pdf / dxf und Montageanleitung siehe:
V. disegno in formato pdf / dxf e montaggio:
suter.ch

Optionales Zubehör / Accessori opzionali

310

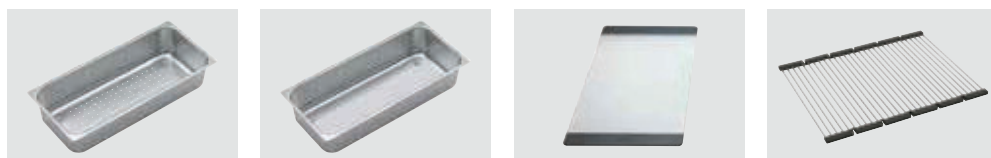

Resteschale gelocht
Vaschetta forata
CHF 106.– 40.000.912.00

Resteschale ungelocht
Vaschetta non forata
CHF 106.– 40.001.289.00

Schneidebrett aus Glas
Tagliere in vetro
CHF 151.– 40.000.909.00

Inox Pad
CHF 125.– 40.001.140.00

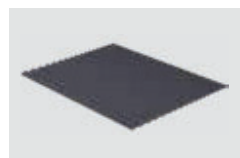

Maro Abtropfmatte aus Silikon
Maro tappetino scolapiatti in silicone
CHF 51.– 40.002.008.00

Flächenbündiger Einbau: Empfehlung zur Wahl der Arbeitsplatte

Wir empfehlen den Einbau in Arbeitsplatten aus Keramik, Granit, Kunststein (z.B. Corian oder Varicor) oder Massivholz. Vom Einbau in beschichtete Spanplatten raten wir ab.

Montaggio a filo top: Consiglio per la scelta del piano di lavoro

Consigliamo il montaggio nei piani di lavoro in ceramica, granito, pietra artificiale (per es. Corian o Varicor) oppure in legno massiccio. Sconsigliamo la posa in pannelli di truciolato rivestiti.

1 Produktausführung, 2 Montagearten

Der besondere Vorteil von IF-Modellen: Sowohl der flächenbündige Einbau als auch der flach aufliegende Einbau ist möglich.

1 versione di prodotto, 2 metodi di montaggio

I modelli IF presentano un grande vantaggio: possono essere posati sia a filo top che sopra piano.

Varianten: Für die flächenbündige Spüle Daneo mit Standard Zugknopf Advant Chrom bestellen Sie
xx.xxx.xx.01 Standardartikel ohne Zugknopf. Reduktion CHF 24.–. Im Austausch wählen Sie den gewünschten Zugknopf auf Seite 358.
Varianti: per il lavello a filo top Daneo con pomolo standard Advant cromato, ordinate
xx.xxx.xx.01 – Articolo standard senza pomolo. Riduzione di CHF 24.–. In sostituzione, scegliete il pomolo desiderato a pagina 358.

Preis CHF / Prezzo in CHF

Modell Modèle	Material Materiale	Ventil Piletta	Artikel-Nr. No. d'article	Tropfteil Scolatoio	Exkl. MWST Excl. TVA	Inkl. MWST Incl. TVA	VRG TRA	
Daneo DAN 110-55IF	Edelstahl, matt Acier inox, brossé	18/10	3½" TouchFlow	Links / Sinistra	A	2415.–	2611.–	0.19
				Rechts / Destra				
			3½" Raumspär Extra plate	Links / Sinistra	A	2217.–	2397.–	
				Rechts / Destra				
			3½" Tipo	Links / Sinistra	A	2176.–	2352.–	
				Rechts / Destra				

Daneo: DAN 40IF/A

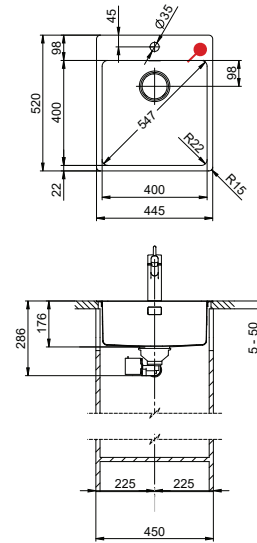
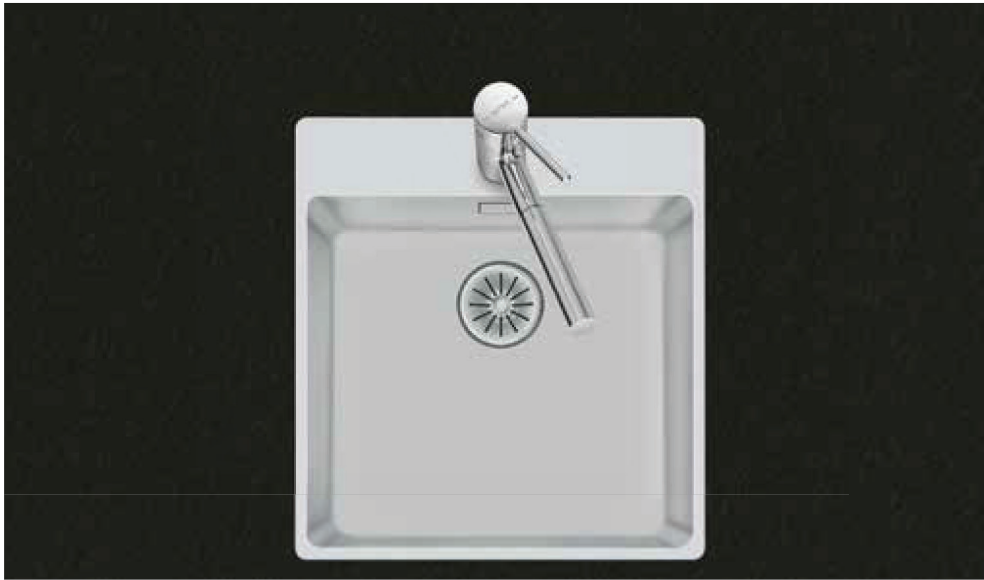

Schwenkbare Überlaufkappe
Placchetta di troppopieno a ribalta

Obenliegendes Sieb
Griglietta superiore



Zeichnung als pdf / dxf und Montageanleitung siehe:
V. disegno in formato pdf / dxf e montaggio:
suter.ch

Optionales Zubehör / Accessori opzionali

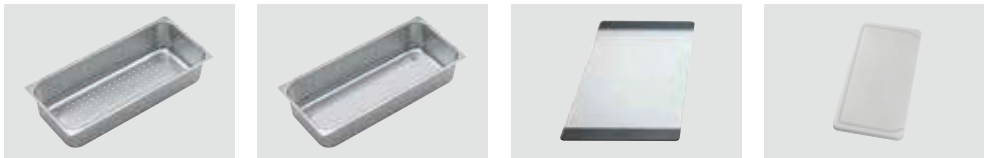

Resteschale gelocht
Vaschetta forato
CHF 106.– 40.000.912.00

Resteschale ungelocht
Vaschetta non forato
CHF 106.– 40.001.289.00

Schneidebrett aus Glas
Tagliere in vetro
CHF 151.– 40.000.909.00

Schneidebrett aus Kunststoff
Tagliere sintetico
CHF 151.– 40.001.277.00

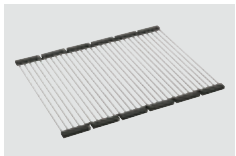

Innox Pad
CHF 125.– 40.001.138.00

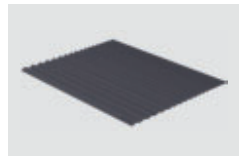

Maro Abtropfmatte aus Silikon
Maro tappetino scolapiatti in silicone
CHF 51.– 40.002.008.00

Flächenbündiger Einbau: Empfehlung zur Wahl der Arbeitsplatte
Wir empfehlen den Einbau in Arbeitsplatten aus Keramik, Granit, Kunststein (z.B. Corian oder Varicor) oder Massivholz. Vom Einbau in beschichtete Spanplatten raten wir ab.

Montaggio a filo top: Consiglio per la scelta del piano di lavoro
Consigliamo il montaggio nei piani di lavoro in ceramica, granito, pietra artificiale (per es. Corian o Varicor) oppure in legno massiccio. Sconsigliamo la posa in pannelli di truciolato rivestiti.

1 Produktausführung, 2 Montagearten
Der besondere Vorteil von IF-Modellen: Sowohl der flächenbündige Einbau als auch der flach aufliegende Einbau ist möglich.

1 versione di prodotto, 2 metodi di montaggio
I modelli IF presentano un grande vantaggio: possono essere posati sia a filo top che sopra piano.

Preis CHF / Prezzo in CHF

Modell Modello	Material Materiale	Ventil Piletta	Artikel-Nr. N. di articolo	Beckentiefe Profondità	Exkl. MWST IVA esclusa	Inkl. MWST IVA inclusa	VRG TRA	
Daneo DAN 40IF/A	Edelstahl, matt Acciaio inox, opaco	18/10	3 1/2" TouchFlow	10.104.806.00	175 mm	A 1540.–	1665.–	0.19
			3 1/2" Tipo	10.104.807.00	175 mm	A 1301.–	1406.–	

Daneo: DAN 50IF/A



Schwenkbare Überlaufkappe
Placchetta di troppopieno a ribalta

27

Obenliegendes Sieb
Griglietta superiore

26

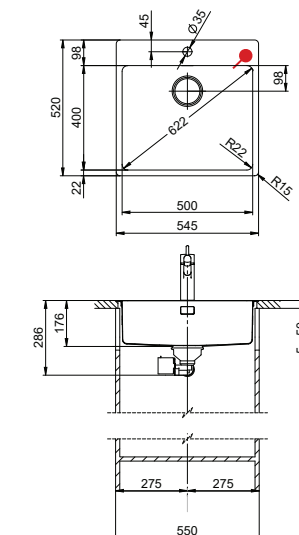

Zeichnung als pdf / dxf und Montageanleitung siehe:
V. disegno in formato pdf / dxf e montaggio:
suter.ch

Optionales Zubehör / Accessori opzionali

310

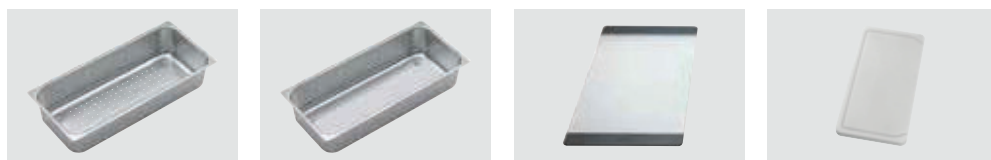

Resteschale gelocht
Vaschetta forata

CHF 106.– 40.000.912.00

Resteschale ungelocht
Vaschetta non forata

CHF 106.– 40.001.289.00

Schneidebrett aus Glas
Tagliere in vetro

CHF 151.– 40.000.909.00

Schneidebrett aus Kunststoff
Tagliere sintetico

CHF 151.– 40.001.277.00

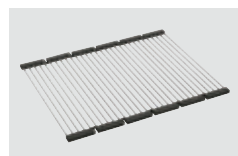

Innox Pad

CHF 125.– 40.001.138.00

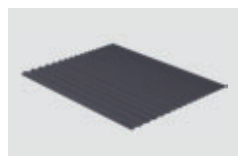

Maro Abtropfmatte aus Silikon
Maro tappetino scolapiatti in silicone

CHF 51.– 40.002.008.00

Flächenbündiger Einbau: Empfehlung zur Wahl der Arbeitsplatte

Wir empfehlen den Einbau in Arbeitsplatten aus Keramik, Granit, Kunststein (z.B. Corian oder Varicor) oder Massivholz. Vom Einbau in beschichtete Spanplatten raten wir ab.

Montaggio a filo top: Consiglio per la scelta del piano di lavoro

Consigliamo il montaggio nei piani di lavoro in ceramica, granito, pietra artificiale (per es. Corian o Varicor) oppure in legno massiccio. Sconsigliamo la posa in pannelli di truciolato rivestiti.

1 Produktausführung, 2 Montagearten

Der besondere Vorteil von IF-Modellen: Sowohl der flächenbündige Einbau als auch der flach aufliegende Einbau ist möglich.

1 versione di prodotto, 2 metodi di montaggio

I modelli IF presentano un grande vantaggio: possono essere posati sia a filo top che sopra piano.

Preis CHF / Prezzo in CHF

Modell Modello	Material Materiale	Ventil Piletta	Artikel-Nr. N. di articolo	Beckentiefe Profondità	Exkl. MWST IVA esclusa	Inkl. MWST IVA inclusa	VRG TRA		
Daneo DAN 50IF/A	Edelstahl, matt Acciaio inox, opaco	18/10	3 1/2" TouchFlow	10.103.586.00	175 mm	A	1641.–	1774.–	0.19
			3 1/2" Tipo	10.103.587.00	175 mm	A	1402.–	1516.–	

Daneo: DAN 55IF/A

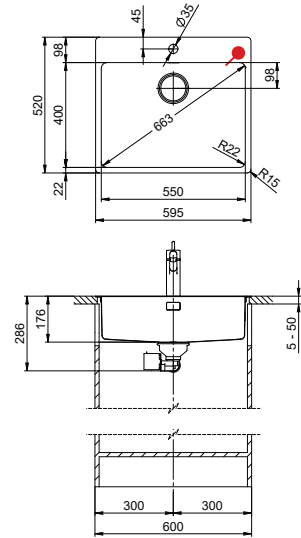

Schwenkbare Überlaufkappe
Placchetta di troppopieno a ribalta

27

Obenliegendes Sieb
Griglietta superiore

26



Zeichnung als pdf / dxf und Montageanleitung siehe:
V. disegno in formato pdf / dxf e montaggio:
suter.ch

Optionales Zubehör / Accessori opzionali

310

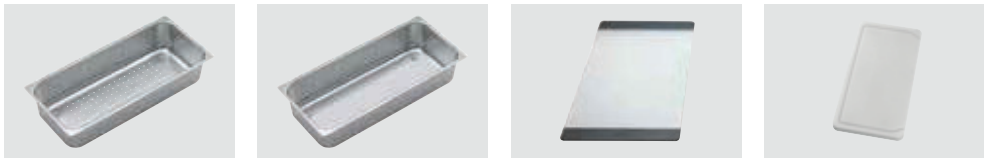

Resteschale gelocht
Vaschetta forato
CHF 106.- 40.000.912.00

Resteschale ungelocht
Vaschetta non forato
CHF 106.- 40.001.289.00

Schneidebrett aus Glas
Tagliere in vetro
CHF 151.- 40.000.909.00

Schneidebrett aus Kunststoff
Tagliere sintetico
CHF 151.- 40.001.277.00

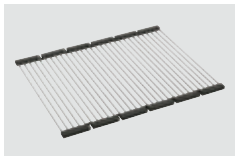

Inox Pad
CHF 125.- 40.001.138.00

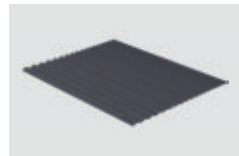

Maro Abtropfmatte aus Silikon
Maro tappetino scolapiatti in silicone
CHF 51.- 40.002.008.00

Flächenbündiger Einbau: Empfehlung zur Wahl der Arbeitsplatte

Wir empfehlen den Einbau in Arbeitsplatten aus Keramik, Granit, Kunststein (z.B. Corian oder Varicor) oder Massivholz. Vom Einbau in beschichtete Spanplatten raten wir ab.

Montaggio a filo top: Consiglio per la scelta del piano di lavoro

Consigliamo il montaggio nei piani di lavoro in ceramica, granito, pietra artificiale (per es. Corian o Varicor) oppure in legno massiccio. Sconsigliamo la posa in pannelli di truciolato rivestiti.

1 Produktausführung, 2 Montagearten

Der besondere Vorteil von IF-Modellen: Sowohl der flächenbündige Einbau als auch der flach aufliegende Einbau ist möglich.

1 versione di prodotto, 2 metodi di montaggio

I modelli IF presentano un grande vantaggio: possono essere posati sia a filo top che sopra piano.

Preis CHF / Prezzo in CHF

Modell Modello	Material Materiale	Ventil Piletta	Artikel-Nr. N. di articolo	Beckentiefe Profondità	Exkl. MWST IVA esclusa	Inkl. MWST IVA inclusa	VRG TRA	
Daneo DAN 55IF/A	Edelstahl, matt Acciaio inox, opaco	18/10	3 1/2" TouchFlow	10.104.808.00	175 mm	A 1742.-	1883.-	0.19
			3 1/2" Tipo	10.104.809.00	175 mm	A 1503.-	1625.-	

Daneo: DAN 100-50IF/A

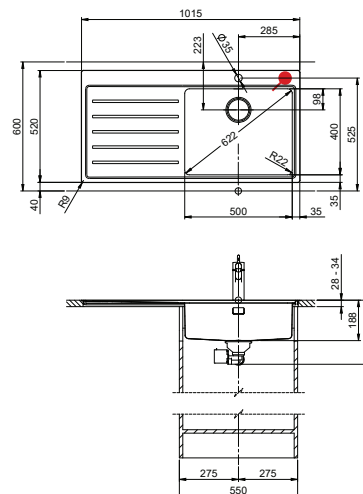

Schwenkbare Überlaufkappe
Placchetta di troppopieno a ribalta

Obenliegendes Sieb
Griglietta superiore

26



Zeichnung als pdf / dxf und Montageanleitung siehe:
V. disegno in formato pdf / dxf e montaggio:
suter.ch

Optionales Zubehör / Accessori opzionali

310

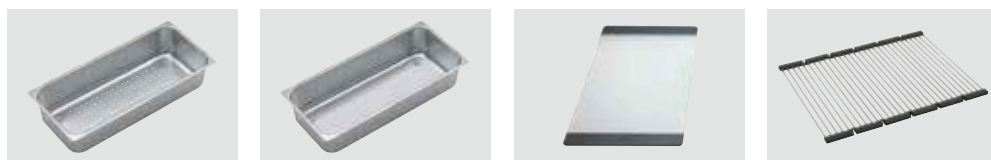

Resteschale gelocht
Vaschetta forato
CHF 106.- 40.000.912.00

Resteschale ungelocht
Vaschetta non forato
CHF 106.- 40.001.289.00

Schneidebrett aus Glas
Tagliere in vetro
CHF 151.- 40.000.909.00

Inox Pad
CHF 125.- 40.001.140.00

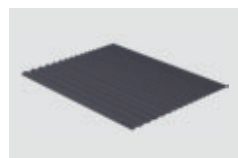

Maro Abtropfmatte aus Silikon
Maro tappetino scolapiatti in silicone
CHF 51.- 40.002.008.00

Flächenbündiger Einbau: Empfehlung zur Wahl der Arbeitsplatte

Wir empfehlen den Einbau in Arbeitsplatten aus Keramik, Granit, Kunststein (z.B. Corian oder Varicor) oder Massivholz. Vom Einbau in beschichtete Spanplatten raten wir ab.

Montaggio a filo top: Consiglio per la scelta del piano di lavoro

Consigliamo il montaggio nei piani di lavoro in ceramica, granito, pietra artificiale (per es. Corian o Varicor) oppure in legno massiccio. Sconsigliamo la posa in pannelli di truciolato rivestiti.

1 Produktausführung, 2 Montagearten

Der besondere Vorteil von IF-Modellen: Sowohl der flächenbündige Einbau als auch der flach aufliegende Einbau ist möglich.

1 versione di prodotto, 2 metodi di montaggio

I modelli IF presentano un grande vantaggio: possono essere posati sia a filo top che sopra piano.

Preis CHF / Prezzo in CHF

Modell Modello	Material Materiale	Ventil Piletta	Artikel-Nr. N. di articolo	Tropfteil Scolatoio	Exkl. MWST IVA esclusa	Inkl. MWST IVA inclusa	VRG TRA
Daneo DAN 100-50IF/A	Edelstahl, matt Acciaio inox, opaco	3 1/2" TouchFlow	10.103.550.00	Links / Sinistra	A	2428.-	2625.-
			10.103.553.00	Rechts / Destra			
		3 1/2" Tipo	10.103.551.00	Links / Sinistra	A	2189.-	2366.-
			10.103.552.00	Rechts / Destra			

Daneo: DAN 100-50IF/A EL

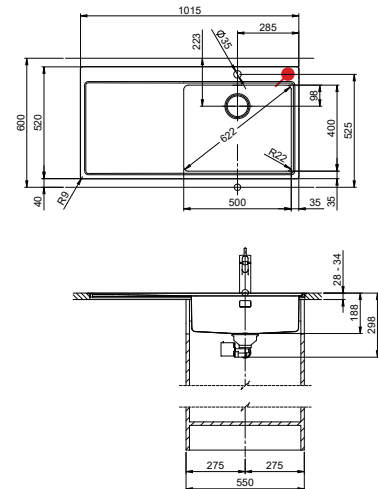
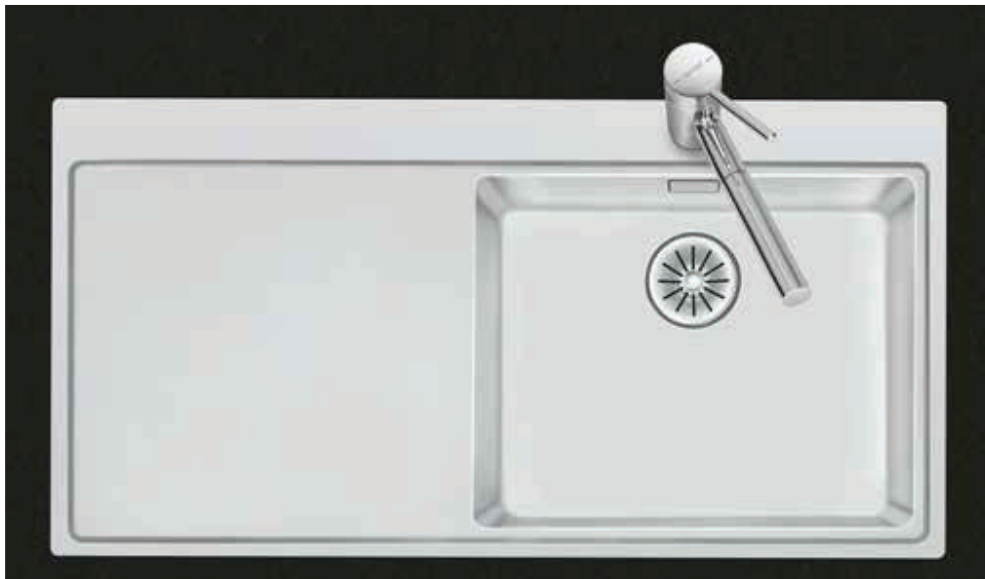

Schwenkbare Überlaufkappe
Placchetta di troppopieno a ribalta

Obenliegendes Sieb
Griglietta superiore

26



Zeichnung als pdf / dxf und Montageanleitung siehe:
V. disegno in formato pdf / dxf e montaggio:
suter.ch

Optionales Zubehör / Accessori opzionali

310



Resteschale gelocht
Vaschetta forato
CHF 106.- 40.000.912.00



Resteschale ungelocht
Vaschetta non forato
CHF 106.- 40.001.289.00



Schneidebrett aus Glas
Tagliere in vetro
CHF 151.- 40.000.909.00

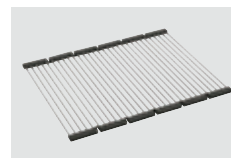

Inox Pad
CHF 125.- 40.001.140.00

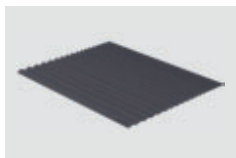

Maro Abtropfmatte aus Silikon
Maro tappetino scolapiatti in silicone
CHF 51.- 40.002.008.00

Flächenbündiger Einbau: Empfehlung zur Wahl der Arbeitsplatte
Wir empfehlen den Einbau in Arbeitsplatten aus Keramik, Granit, Kunststein (z.B. Corian oder Varicor) oder Massivholz. Vom Einbau in beschichtete Spanplatten raten wir ab.

Montaggio a filo top: Consiglio per la scelta del piano di lavoro
Consigliamo il montaggio nei piani di lavoro in ceramica, granito, pietra artificiale (per es. Corian o Varicor) oppure in legno massiccio. Sconsigliamo la posa in pannelli di truciolato rivestiti.

1 Produktausführung, 2 Montagearten
Der besondere Vorteil von IF-Modellen: Sowohl der flächenbündige Einbau als auch der flach aufliegende Einbau ist möglich.

1 versione di prodotto, 2 metodi di montaggio
I modelli IF presentano un grande vantaggio: possono essere posati sia a filo top che sopra piano.

Preis CHF / Prezzo in CHF

Modell Modello	Material Materiale	Ventil Piletta	Artikel-Nr. N. di articolo	Tropfteil Scolatoio	Exkl. MWST IVA esclusa	Inkl. MWST IVA inclusa	VRG TRA
Daneo DAN 100-50IF/A EL	Edelstahl, matt Acciaio inox, opaco	3 1/2" TouchFlow	10.104.821.00	Links / Sinistra	A	2428.-	2625.-
			10.104.822.00	Rechts / Destra			
		3 1/2" Tipo	10.104.823.00	Links / Sinistra	A	2189.-	2366.-
			10.104.824.00	Rechts / Destra			

Daneo: DAN 100-55IF/A

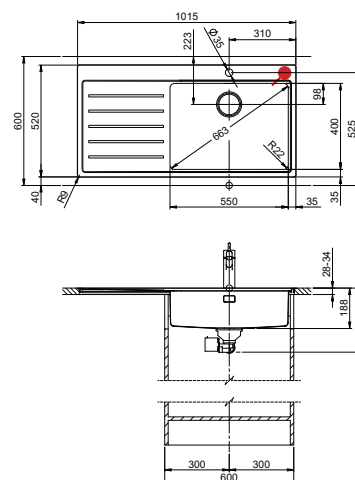
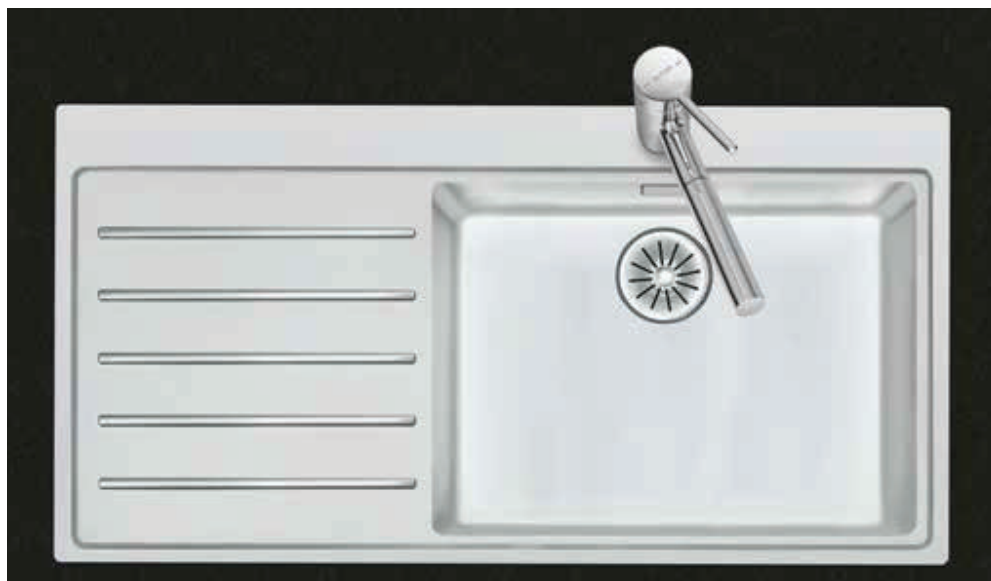

Schwenkbare Überlaufkappe
Placchetta di troppopieno a ribalta

Obenliegendes Sieb
Griglietta superiore

26



Zeichnung als pdf / dxf und Montageanleitung siehe:
V. disegno in formato pdf / dxf e montaggio:
suter.ch

Optionales Zubehör / Accessori opzionali

310

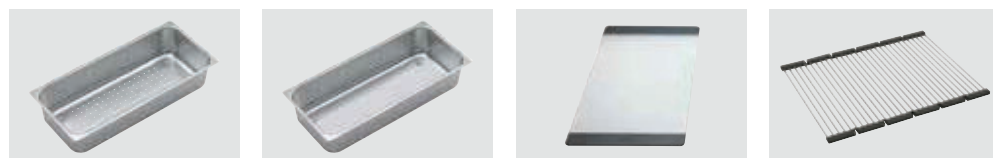

Resteschale gelocht
Vaschetta forato
CHF 106.- 40.000.912.00

Resteschale ungelocht
Vaschetta non forato
CHF 106.- 40.001.289.00

Schneidebrett aus Glas
Tagliere in vetro
CHF 151.- 40.000.909.00

Inox Pad
CHF 125.- 40.001.140.00

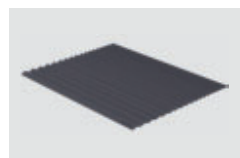

Maro Abtropfmatte aus Silikon
Maro tappetino scolapiatti in silicone
CHF 51.- 40.002.008.00

Flächenbündiger Einbau: Empfehlung zur Wahl der Arbeitsplatte

Wir empfehlen den Einbau in Arbeitsplatten aus Keramik, Granit, Kunststein (z.B. Corian oder Varicor) oder Massivholz. Vom Einbau in beschichtete Spanplatten raten wir ab.

Montaggio a filo top: Consiglio per la scelta del piano di lavoro

Consigliamo il montaggio nei piani di lavoro in ceramica, granito, pietra artificiale (per es. Corian o Varicor) oppure in legno massiccio. Sconsigliamo la posa in pannelli di truciolato rivestiti.

1 Produktausführung, 2 Montagearten

Der besondere Vorteil von IF-Modellen: Sowohl der flächenbündige Einbau als auch der flach aufliegende Einbau ist möglich.

1 versione di prodotto, 2 metodi di montaggio

I modelli IF presentano un grande vantaggio: possono essere posati sia a filo top che sopra piano.

Preis CHF / Prezzo in CHF

Modell Modello	Material Materiale	Ventil Piletta	Artikel-Nr. N. di articolo	Tropfteil Scolatoio	Exkl. MWST IVA esclusa	Inkl. MWST IVA inclusa	VRG TRA
Daneo DAN 100-55IF/A	Edelstahl, matt Acciaio inox, opaco	3 1/2" TouchFlow	10.103.970.00	Links / Sinistra	A	2541.-	2747.-
			10.103.971.00	Rechts / Destra			
		3 1/2" Tipo	10.103.972.00	Links / Sinistra	A	2302.-	2488.-
			10.103.973.00	Rechts / Destra			

Daneo: DAN 110-50IF/A

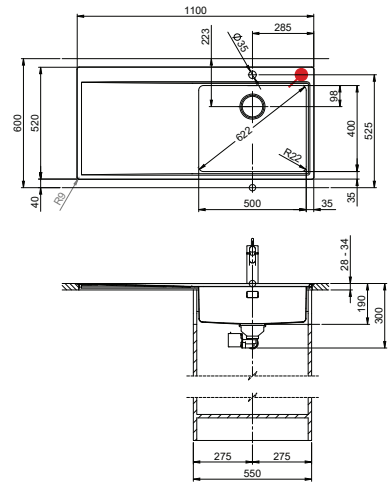

Schwenkbare Überlaufkappe
Placchetta di troppopieno a ribalta

Obenliegendes Sieb
Griglietta superiore



Zeichnung als pdf / dxf und Montageanleitung siehe:
V. disegno in formato pdf / dxf e montaggio:
suter.ch

Optionales Zubehör / Accessori opzionali

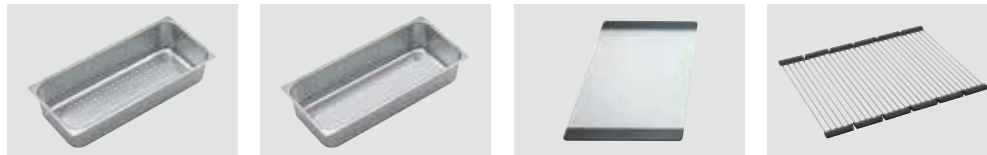

Resteschale gelocht
Vaschetta forato
CHF 106.– 40.000.912.00

Resteschale ungelocht
Vaschetta non forato
CHF 106.– 40.001.289.00

Schneidebrett aus Glas
Tagliere in vetro
CHF 151.– 40.000.909.00

Inox Pad
CHF 125.– 40.001.140.00

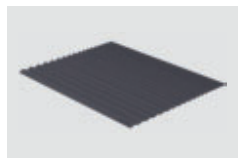

Maro Abtropfmatte aus Silikon
Maro tappetino scolapiatti in silicone
CHF 51.– 40.002.008.00

Flächenbündiger Einbau: Empfehlung zur Wahl der Arbeitsplatte
Wir empfehlen den Einbau in Arbeitsplatten aus Keramik, Granit, Kunststein (z.B. Corian oder Varicor) oder Massivholz. Vom Einbau in beschichtete Spanplatten raten wir ab.

Montaggio a filo top: Consiglio per la scelta del piano di lavoro
Consigliamo il montaggio nei piani di lavoro in ceramica, granito, pietra artificiale (per es. Corian o Varicor) oppure in legno massiccio. Sconsigliamo la posa in pannelli di truciolato rivestiti.

1 Produktausführung, 2 Montagearten
Der besondere Vorteil von IF-Modellen: Sowohl der flächenbündige Einbau als auch der flach aufliegende Einbau ist möglich.

1 versione di prodotto, 2 metodi di montaggio
I modelli IF presentano un grande vantaggio: possono essere posati sia a filo top che sopra piano.

Preis CHF / Prezzo in CHF

Modell Modello	Material Materiale	Ventil Piletta	Artikel-Nr. N. di articolo	Tropfteil Scolatoio	Exkl. MWST IVA esclusa	Inkl. MWST IVA inclusa	VRG TRA
Daneo DAN 110-50IF/A	Edelstahl, matt Acciaio inox, opaco	3 1/2" TouchFlow	10.103.798.00	Links / Sinistra	A	2489.–	2691.–
			10.103.799.00	Rechts / Destra			
		3 1/2" Tipo	10.103.800.00	Links / Sinistra	A	2250.–	2432.–
			10.103.801.00	Rechts / Destra			

Daneo: DAN 110-55IF/A

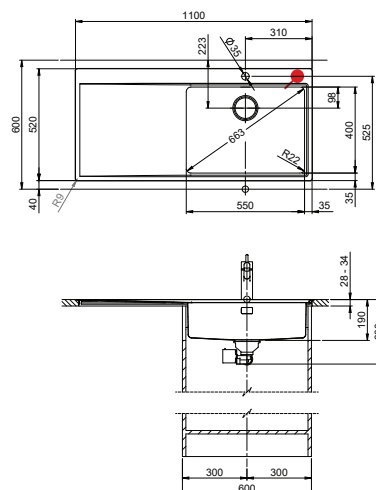

Schwenkbare Überlaufkappe
Placchetta di troppopieno a ribalta

Obenliegendes Sieb
Griglietta superiore



Zeichnung als pdf / dxf und Montageanleitung siehe:
V. disegno in formato pdf / dxf e montaggio:
suter.ch

Optionales Zubehör / Accessori opzionali

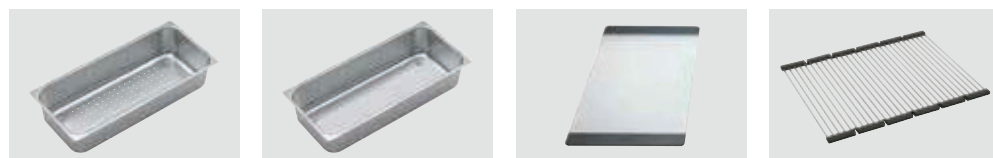

Resteschale gelocht
Vaschetta forato
CHF 106.- 40.000.912.00

Resteschale ungelocht
Vaschetta non forato
CHF 106.- 40.001.289.00

Schneidebrett aus Glas
Tagliere in vetro
CHF 151.- 40.000.909.00

Inox Pad
CHF 125.- 40.001.140.00

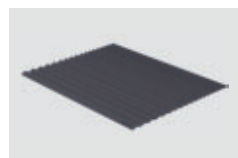

Maro Abtropfmatte aus Silikon
Maro tappetino scolapiatti in silicone
CHF 51.- 40.002.008.00

Flächenbündiger Einbau: Empfehlung zur Wahl der Arbeitsplatte

Wir empfehlen den Einbau in Arbeitsplatten aus Keramik, Granit, Kunststein (z.B. Corian oder Varicor) oder Massivholz. Vom Einbau in beschichtete Spanplatten raten wir ab.

Montaggio a filo top: Consiglio per la scelta del piano di lavoro

Consigliamo il montaggio nei piani di lavoro in ceramica, granito, pietra artificiale (per es. Corian o Varicor) oppure in legno massiccio. Sconsigliamo la posa in pannelli di truciolato rivestiti.

1 Produktausführung, 2 Montagearten

Der besondere Vorteil von IF-Modellen: Sowohl der flächenbündige Einbau als auch der flach aufliegende Einbau ist möglich.

1 versione di prodotto, 2 metodi di montaggio

I modelli IF presentano un grande vantaggio: possono essere posati sia a filo top che sopra piano.

Preis CHF / Prezzo in CHF

Modell Modello	Material Materiale	Ventil Piletta	Artikel-Nr. N. di articolo	Tropfteil Scolatoio	Exkl. MWST IVA esclusa	Inkl. MWST IVA inclusa	VRG TRA
Daneo DAN 110-55IF/A	Edelstahl, matt Acciaio inox, opaco	3 1/2" TouchFlow	10.103.802.00	Links / Sinistra	A	2601.-	2812.-
			10.103.803.00	Rechts / Destra			
		3 1/2" Tipo	10.103.804.00	Links / Sinistra	A	2362.-	2553.-
			10.103.805.00	Rechts / Destra			

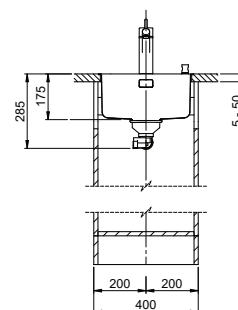
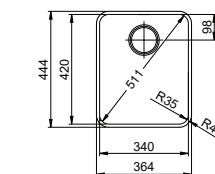

Vantis: V 34IF/12

Randbreite 12 mm
Larghezza bordo 12 mm

 Schwenkbare Überlaufkappe
Placchetta di troppopieno a ribalta

27

 Obenliegendes Sieb
Griglietta superiore

26



Zeichnung als pdf / dxf und Montageanleitung siehe:
V. disegno in formato pdf / dxf e montaggio:
suter.ch

Optionales Zubehör / Accessori opzionali

310

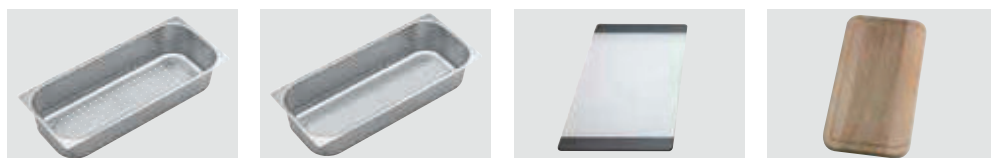
Resteschale gelocht
Vaschetta forata

CHF 106.– 40.000.914.00

Resteschale ungelocht
Vaschetta non forata

CHF 106.– 40.001.290.00

Schneidebrett aus Glas
Tagliere in vetro

CHF 151.– 40.000.915.00

Holz-Schneidebrett aus Nussbaum
Tagliere in legno di noce

CHF 151.– 40.001.147.00

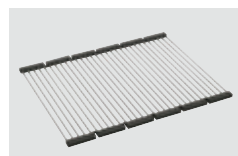
Innox Pad

CHF 125.– 40.001.138.00

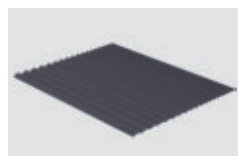
Maro Abtropfmatte aus Silikon
Maro tappetino scolapiatti in silicone

CHF 51.– 40.002.008.00

Flächenbündiger Einbau: Empfehlung zur Wahl der Arbeitsplatte

Wir empfehlen den Einbau in Arbeitsplatten aus Keramik, Granit, Kunststein (z.B. Corian oder Varicor) oder Massivholz. Vom Einbau in beschichtete Spanplatten raten wir ab.

Montaggio a filo top: Consiglio per la scelta del piano di lavoro

Consigliamo il montaggio nei piani di lavoro in ceramica, granito, pietra artificiale (per es. Corian o Varicor) oppure in legno massiccio. Sconsigliamo la posa in pannelli di truciolato rivestiti.

1 Produktausführung, 2 Montagearten

Der besondere Vorteil von IF-Modellen: Sowohl der flächenbündige Einbau als auch der flach aufliegende Einbau ist möglich.

1 versione di prodotto, 2 metodi di montaggio

I modelli IF presentano un grande vantaggio: possono essere posati sia a filo top che sopra piano.

! **Varianten: Für die flächenbündige Spüle Vantis mit Standard Zugknopf Prime Chrom bestellen Sie**
xx.xxx.xx.01 Standardartikel ohne Zugknopf. Reduktion CHF 24.–. Im Austausch wählen Sie den gewünschten Zugknopf auf Seite 358.
Varianti: per il lavello a filo top Vantis con pomolo standard Prime cromato, ordinate
xx.xxx.xx.01 – Articolo standard senza pomolo. Riduzione di CHF 24.–. In sostituzione, scegliete il pomolo desiderato a pagina 358.

Preis CHF/Prezzo in CHF

Modell Modello	Material Materiale	Ventil sFlow, Typ S Piletta sFlow, tipo S	Artikel-Nr. N. di articolo	Beckentiefe Profondità	Exkl. MWST IVA esclusa	Inkl. MWST IVA inclusa	VRG TRA		
Vantis V 34IF/12	Edelstahl, matt Acciaio inox, opaco	18/10	3 1/2" TouchFlow	10.104.218.00	175 mm	A	1011.–	1093.–	0.19
			3 1/2" Raumspaar Salvaspazio	10.104.219.00	175 mm	A	813.–	879.–	
			3 1/2" Tipo	10.104.220.00	175 mm	A	772.–	835.–	

Vantis: V 34IF/12

Randbreite 12 mm
Larghezza bordo 12 mm

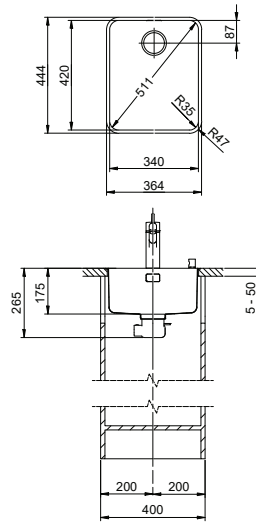

eFlow mit eControl
eFlow con eControl

Schwenkbare Überlaufkappe
Placchetta di troppopieno a ribalta

Desino: Verdeckter Ablauf mit untenliegendem Sieb
Desino: Scarico coperto con griglietta inferiore



Für eFlow Desino
Per eFlow Desino



Für TouchFlow Desino und Raumspaar Desino
Per TouchFlow Desino e Salvaspazio Desino



Für eFlow Desino, TouchFlow Desino und Raumspaar Desino
Per eFlow Desino, TouchFlow Desino e Salvaspazio Desino

Optionales Zubehör / Accessori opzionali

310



Resteschale gelocht
Vaschetta forata
CHF 106.– 40.000.914.00



Resteschale ungelocht
Vaschetta non forata
CHF 106.– 40.001.290.00

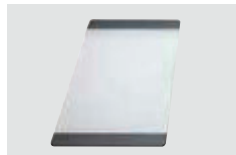

Schneidebrett aus Glas
Tagliere in vetro
CHF 151.– 40.000.915.00



Holz-Schneidebrett aus Nussbaum
Tagliere in legno di noce
CHF 151.– 40.001.147.00

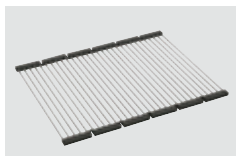

Inox Pad
CHF 125.– 40.001.138.00

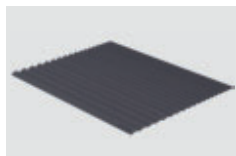

Maro Abtropfmatte aus Silikon
Maro tappetino scolapiatti in silicone
CHF 51.– 40.002.008.00

Zeichnung als pdf / dxf und Montageanleitung siehe:
V. disegno in formato pdf / dxf e montaggio:
suter.ch

Flächenbündiger Einbau: Empfehlung zur Wahl der Arbeitsplatte

Wir empfehlen den Einbau in Arbeitsplatten aus Keramik, Granit, Kunststein (z.B. Corian oder Varicor) oder Massivholz. Vom Einbau in beschichtete Spanplatten raten wir ab.

Montaggio a filo top: Consiglio per la scelta del piano di lavoro

Consigliamo il montaggio nei piani di lavoro in ceramica, granito, pietra artificiale (per es. Corian o Varicor) oppure in legno massiccio. Sconsigliamo la posa in pannelli di truciolato rivestiti.

1 Produktausführung, 2 Montagearten

Der besondere Vorteil von IF-Modellen: Sowohl der flächenbündige Einbau als auch der flach aufliegende Einbau ist möglich.

1 versione di prodotto, 2 metodi di montaggio

I modelli IF presentano un grande vantaggio: possono essere posati sia a filo top che sopra piano.

Preis CHF / Prezzo in CHF

Modell Modello	Material Materiale	Ventil sFlow, Typ M Piletta sFlow, tipo M	Artikel-Nr. N. di articolo	Beckentiefe Profondità	Exkl. MWST IVA esclusa	Inkl. MWST IVA inclusa	VRG TRA	
Vantis V 34IF/12	Edelstahl, matt Acciaio inox, opaco	18/10	3 1/2" eFlow Desino	10.105.270.00	175 mm	A 1278.–	1382.–	0.19
			3 1/2" TouchFlow Desino	10.105.271.00	175 mm	A 1163.–	1257.–	0.19
			3 1/2" Raumspaar Desino Salvaspazio Desino	10.105.272.00	175 mm	A 953.–	1030.–	

Vantis: V 40IF/12

Randbreite 12 mm
Larghezza bordo 12 mm

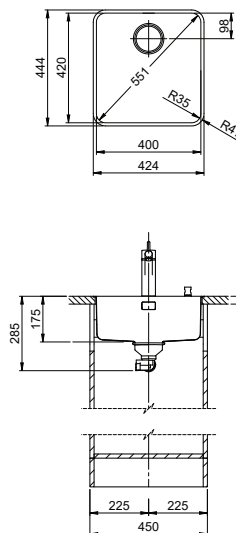

Schwenkbare Überlaufkappe
Placchetta di troppopieno a ribalta

Obenliegendes Sieb
Griglietta superiore

26



Zeichnung als pdf / dxf und Montageanleitung siehe:
V. disegno in formato pdf / dxf e montaggio:
suter.ch

Optionales Zubehör / Accessori opzionali

310

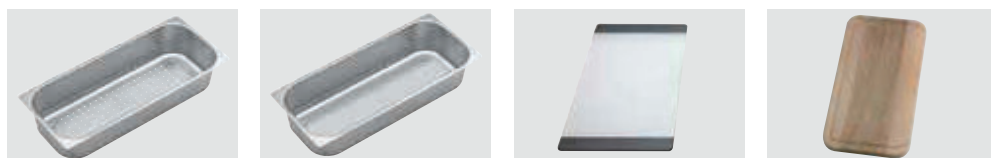

Resteschale gelocht
Vaschetta forato
CHF 106.– 40.000.914.00

Resteschale ungelocht
Vaschetta non forato
CHF 106.– 40.001.290.00

Schneidebrett aus Glas
Tagliere in vetro
CHF 151.– 40.000.915.00

Holz-Schneidebrett aus Nussbaum
Tagliere in legno di noce
CHF 151.– 40.001.147.00

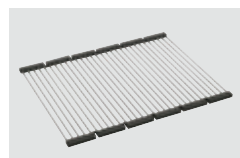

Inox Pad
CHF 125.– 40.001.138.00

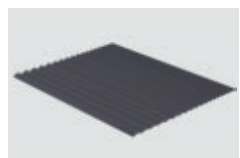

Maro Abtropfmatte aus Silikon
Maro tappetino scolapiatti in silicone
CHF 51.– 40.002.008.00

Flächenbündiger Einbau: Empfehlung zur Wahl der Arbeitsplatte

Wir empfehlen den Einbau in Arbeitsplatten aus Keramik, Granit, Kunststein (z.B. Corian oder Varicor) oder Massivholz. Vom Einbau in beschichtete Spanplatten raten wir ab.

Montaggio a filo top: Consiglio per la scelta del piano di lavoro

Consigliamo il montaggio nei piani di lavoro in ceramica, granito, pietra artificiale (per es. Corian o Varicor) oppure in legno massiccio. Sconsigliamo la posa in pannelli di truciolato rivestiti.

1 Produktausführung, 2 Montagearten

Der besondere Vorteil von IF-Modellen: Sowohl der flächenbündige Einbau als auch der flach aufliegende Einbau ist möglich.

1 versione di prodotto, 2 metodi di montaggio

I modelli IF presentano un grande vantaggio: possono essere posati sia a filo top che soprapiano.

Varianten: Für die flächenbündige Spüle Vantis mit Standard Zugknopf Prime Chrom bestellen Sie
xx.xxx.xx.01 Standardartikel ohne Zugknopf. Reduktion CHF 24.–. Im Austausch wählen Sie den gewünschten Zugknopf auf Seite 358.
Varianti: per il lavello a filo top Vantis con pomolo standard Prime cromato, ordinate
xx.xxx.xx.01 – Articolo standard senza pomolo. Riduzione di CHF 24.–. In sostituzione, scegliete il pomolo desiderato a pagina 358.

Preis CHF / Prezzo in CHF

Modell Modello	Material Materiale	Ventil sFlow, Typ S Piletta sFlow, tipo S	Artikel-Nr. N. di articolo	Beckentiefe Profondità	Exkl. MWST IVA esclusa	Inkl. MWST IVA inclusa	VRG TRA		
Vantis V 40IF/12	Edelstahl, matt Acciaio inox, opaco	18/10	3 1/2" TouchFlow	10.104.224.00	175 mm	A	1048.–	1133.–	0.19
			3 1/2" Raumspär Salvaspazio	10.104.225.00	175 mm	A	850.–	919.–	
			3 1/2" Tipo	10.104.226.00	175 mm	A	809.–	875.–	

Vantis: V 40IF/12

Randbreite 12 mm
Larghezza bordo 12 mm

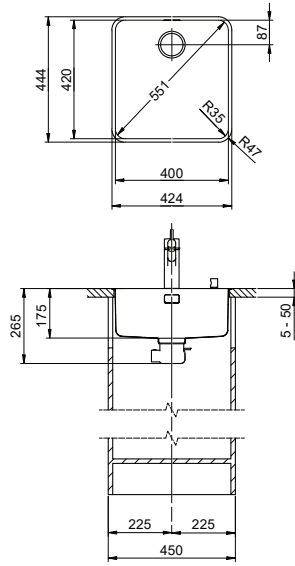

eFlow mit eControl
eFlow con eControl

Schwenkbare Überlaufkappe
Placchetta di troppopieno a ribalta

Desino: Verdeckter Ablauf mit untenliegendem Sieb
Desino: Scarico coperto con griglietta inferiore



Für eFlow Desino
Per eFlow Desino



Für TouchFlow Desino und Raumspaar Desino
Per TouchFlow Desino e Salvaspazio Desino



Für eFlow Desino, TouchFlow Desino und Raumspaar Desino
Per eFlow Desino, TouchFlow Desino e Salvaspazio Desino



Optionales Zubehör / Accessori opzionali

310



Resteschale gelocht
Vaschetta forato
CHF 106.– 40.000.914.00



Resteschale ungelocht
Vaschetta non forato
CHF 106.– 40.001.290.00

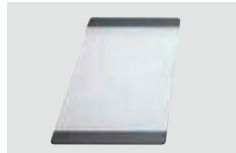

Schneidebrett aus Glas
Tagliere in vetro
CHF 151.– 40.000.915.00



Holz-Schneidebrett aus Nussbaum
Tagliere in legno di noce
CHF 151.– 40.001.147.00

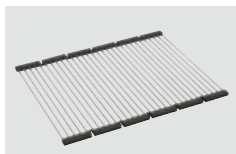

Inox Pad
CHF 125.– 40.001.138.00

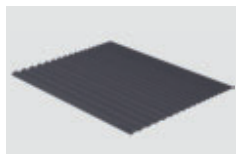

Maro Abtropfmatte aus Silikon
Maro tappetino scolapiatti in silicone
CHF 51.– 40.002.008.00

Zeichnung als pdf / dxf und Montageanleitung siehe:
V. disegno in formato pdf / dxf e montaggio:
suter.ch

Flächenbündiger Einbau: Empfehlung zur Wahl der Arbeitsplatte

Wir empfehlen den Einbau in Arbeitsplatten aus Keramik, Granit, Kunststein (z.B. Corian oder Varicor) oder Massivholz. Vom Einbau in beschichtete Spanplatten raten wir ab.

Montaggio a filo top: Consiglio per la scelta del piano di lavoro

Consigliamo il montaggio nei piani di lavoro in ceramica, granito, pietra artificiale (per es. Corian o Varicor) oppure in legno massiccio. Sconsigliamo la posa in pannelli di truciolato rivestiti.

1 Produktausführung, 2 Montagearten

Der besondere Vorteil von IF-Modellen: Sowohl der flächenbündige Einbau als auch der flach aufliegende Einbau ist möglich.

1 versione di prodotto, 2 metodi di montaggio

I modelli IF presentano un grande vantaggio: possono essere posati sia a filo top che sopra piano.

Preis CHF / Prezzo in CHF

Modell Modello	Material Materiale	Ventil sFlow, Typ M Piletta sFlow, tipo M	Artikel-Nr. N. di articolo	Beckentiefe Profondità	Exkl. MWST IVA esclusa	Inkl. MWST IVA inclusa	VRG TRA
Vantis V 40IF/12	Edelstahl, matt Acciaio inox, opaco	18/10	3 1/2" eFlow Desino	10.105.273.00	175 mm	A 1315.–	1422.– 0.19
			3 1/2" TouchFlow Desino	10.105.274.00	175 mm	A 1200.–	1297.– 0.19
			3 1/2" Raumspaar Desino Salvaspazio Desino	10.105.275.00	175 mm	A 990.–	1070.–

Vantis: V 45IF/12

Randbreite 12 mm
Larghezza bordo 12 mm

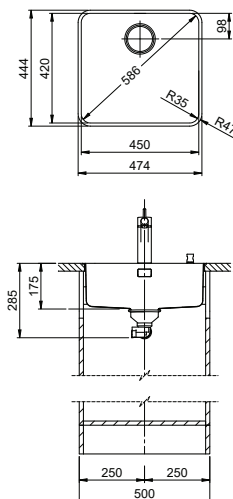

Schwenkbare Überlaufkappe
Placchetta di troppopieno a ribalta

Obenliegendes Sieb
Griglietta superiore

26



Zeichnung als pdf / dxf und Montageanleitung siehe:
V. disegno in formato pdf / dxf e montaggio:
suter.ch

Optionales Zubehör / Accessori opzionali

310

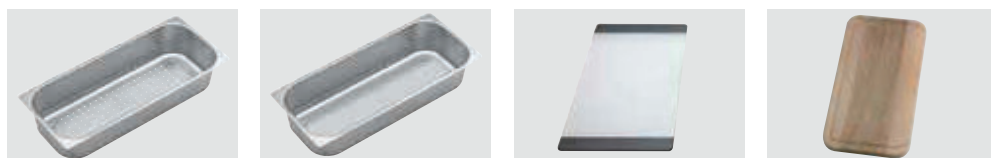

Resteschale gelocht
Vaschetta forata
CHF 106.– 40.000.914.00

Resteschale ungelocht
Vaschetta non forata
CHF 106.– 40.001.290.00

Schneidebrett aus Glas
Tagliere in vetro
CHF 151.– 40.000.915.00

Holz-Schneidebrett aus Nussbaum
Tagliere in legno di noce
CHF 151.– 40.001.147.00

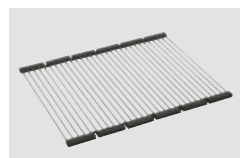

Inox Pad
CHF 125.– 40.001.138.00

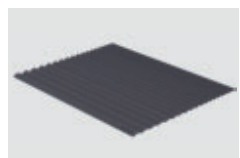

Maro Abtropfmatte aus Silikon
Maro tappetino scolapiatti in silicone
CHF 51.– 40.002.008.00

Flächenbündiger Einbau: Empfehlung zur Wahl der Arbeitsplatte

Wir empfehlen den Einbau in Arbeitsplatten aus Keramik, Granit, Kunststein (z.B. Corian oder Varicor) oder Massivholz. Vom Einbau in beschichtete Spanplatten raten wir ab.

Montaggio a filo top: Consiglio per la scelta del piano di lavoro

Consigliamo il montaggio nei piani di lavoro in ceramica, granito, pietra artificiale (per es. Corian o Varicor) oppure in legno massiccio. Sconsigliamo la posa in pannelli di truciolato rivestiti.

1 Produktausführung, 2 Montagearten

Der besondere Vorteil von IF-Modellen: Sowohl der flächenbündige Einbau als auch der flach aufliegende Einbau ist möglich.

1 versione di prodotto, 2 metodi di montaggio

I modelli IF presentano un grande vantaggio: possono essere posati sia a filo top che soprapiano.

Varianten: Für die flächenbündige Spüle Vantis mit Standard Zugknopf Prime Chrom bestellen Sie
xx.xxx.xx.01 Standardartikel ohne Zugknopf. Reduktion CHF 24.–. Im Austausch wählen Sie den gewünschten Zugknopf auf Seite 358.
Varianti: per il lavello a filo top Vantis con pomolo standard Prime cromato, ordinate
xx.xxx.xx.01 – Articolo standard senza pomolo. Riduzione di CHF 24.–. In sostituzione, scegliete il pomolo desiderato a pagina 358.

Preis CHF/Prezzo in CHF

Modell Modello	Material Materiale	Ventil sFlow, Typ S Piletta sFlow, tipo S	Artikel-Nr. N. di articolo	Beckentiefe Profondità	Exkl. MWST IVA esclusa	Inkl. MWST IVA inclusa	VRG TRA		
Vantis V 45IF/12	Edelstahl, matt Acciaio inox, opaco	18/10	3 1/2" TouchFlow	10.104.230.00	175 mm	A	1095.–	1184.–	0.19
		3 1/2" Raumspär Salvaspazio	10.104.231.00	175 mm	A	897.–	970.–		
		3 1/2" Tipo	10.104.232.00	175 mm	A	848.–	917.–		

Vantis: V 45IF/12

Randbreite 12 mm
Larghezza bordo 12 mm

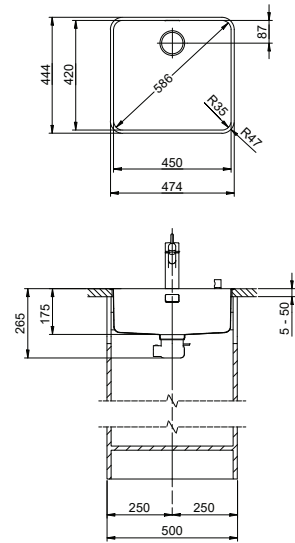

eFlow mit eControl
eFlow con eControl

Schwenkbare Überlaufkappe
Placchetta di troppieno a ribalta

Desino: Verdeckter Ablauf mit untenliegendem Sieb
Desino: Scarico coperto con griglietta inferiore



Für eFlow Desino
Per eFlow Desino



Für TouchFlow Desino und Raumspaar Desino
Per TouchFlow Desino e Salvaspazio Desino



Für eFlow Desino, TouchFlow Desino und Raumspaar Desino
Per eFlow Desino, TouchFlow Desino e Salvaspazio Desino

Optionales Zubehör / Accessori opzionali

310



Resteschale gelocht
Vaschetta forato
CHF 106.– 40.000.914.00



Resteschale ungelocht
Vaschetta non forato
CHF 106.– 40.001.290.00



Schneidebrett aus Glas
Tagliere in vetro
CHF 151.– 40.000.915.00



Holz-Schneidebrett aus Nussbaum
Tagliere in legno di noce
CHF 151.– 40.001.147.00

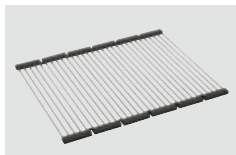

Inox Pad
CHF 125.– 40.001.138.00

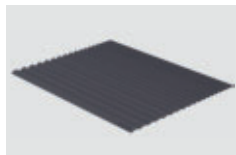

Maro Abtropfmatte aus Silikon
Maro tappetino scolapiatti in silicone
CHF 51.– 40.002.008.00

Zeichnung als pdf / dxf und Montageanleitung siehe:
V. disegno in formato pdf / dxf e montaggio:
suter.ch

Flächenbündiger Einbau: Empfehlung zur Wahl der Arbeitsplatte

Wir empfehlen den Einbau in Arbeitsplatten aus Keramik, Granit, Kunststein (z.B. Corian oder Varicor) oder Massivholz. Vom Einbau in beschichtete Spanplatten raten wir ab.

Montaggio a filo top: Consiglio per la scelta del piano di lavoro

Consigliamo il montaggio nei piani di lavoro in ceramica, granito, pietra artificiale (per es. Corian o Varicor) oppure in legno massiccio. Sconsigliamo la posa in pannelli di truciolato rivestiti.

1 Produktausführung, 2 Montagearten

Der besondere Vorteil von IF-Modellen: Sowohl der flächenbündige Einbau als auch der flach aufliegende Einbau ist möglich.

1 versione di prodotto, 2 metodi di montaggio

I modelli IF presentano un grande vantaggio: possono essere posati sia a filo top che soprapiano.

Preis CHF / Prezzo in CHF

Modell Modello	Material Materiale	Ventil sFlow, Typ M Piletta sFlow, tipo M	Artikel-Nr. N. di articolo	Beckentiefe Profondità	Exkl. MWST IVA esclusa	Inkl. MWST IVA inclusa	VRG TRA
Vantis V 45IF/12	Edelstahl, matt Acciaio inox, opaco	18/10	3 1/2" eFlow Desino	10.105.279.00	175 mm	A 1362.–	1472.– 0.19
			3 1/2" TouchFlow Desino	10.105.210.00	175 mm	A 1247.–	1348.– 0.19
			3 1/2" Raumspaar Desino Salvaspazio Desino	10.105.211.00	175 mm	A 1037.–	1121.–

Vantis: V 50-42IF/12

Randbreite 12 mm
Larghezza bordo 12 mm

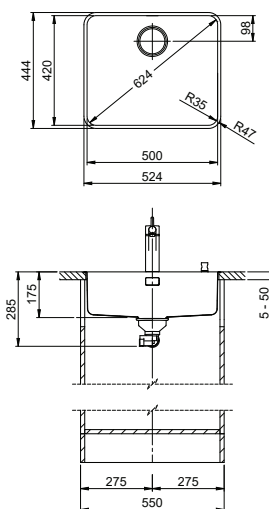

Schwenkbare Überlaufkappe
Placchetta di troppopieno a ribalta

Obenliegendes Sieb
Griglietta superiore

26



Zeichnung als pdf / dxf und Montageanleitung siehe:
V. disegno in formato pdf / dxf e montaggio:
suter.ch

Optionales Zubehör / Accessori opzionali

310

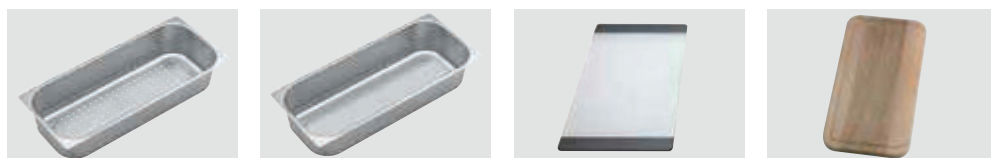

Resteschale gelocht
Vaschetta forata
CHF 106.– 40.000.914.00

Resteschale ungelocht
Vaschetta non forata
CHF 106.– 40.001.290.00

Schneidebrett aus Glas
Tagliere in vetro
CHF 151.– 40.000.915.00

Holz-Schneidebrett aus Nussbaum
Tagliere in legno di noce
CHF 151.– 40.001.147.00

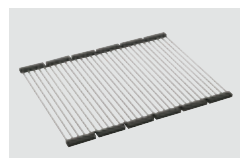

Innox Pad
CHF 125.– 40.001.138.00

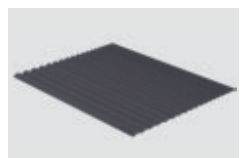

Maro Abtropfmatte aus Silikon
Maro tappetino scolapiatti in silicone
CHF 51.– 40.002.008.00

Flächenbündiger Einbau: Empfehlung zur Wahl der Arbeitsplatte

Wir empfehlen den Einbau in Arbeitsplatten aus Keramik, Granit, Kunststein (z.B. Corian oder Varicor) oder Massivholz. Vom Einbau in beschichtete Spanplatten raten wir ab.

Montaggio a filo top: Consiglio per la scelta del piano di lavoro

Consigliamo il montaggio nei piani di lavoro in ceramica, granito, pietra artificiale (per es. Corian o Varicor) oppure in legno massiccio. Sconsigliamo la posa in pannelli di truciolato rivestiti.

1 Produktausführung, 2 Montagearten

Der besondere Vorteil von IF-Modellen: Sowohl der flächenbündige Einbau als auch der flach aufliegende Einbau ist möglich.

1 versione di prodotto, 2 metodi di montaggio

I modelli IF presentano un grande vantaggio: possono essere posati sia a filo top che sopra piano.

Varianten: Für die flächenbündige Spüle Vantis mit Standard Zugknopf Prime Chrom bestellen Sie
xx.xxx.xx.01 Standardartikel ohne Zugknopf. Reduktion CHF 24.–. Im Austausch wählen Sie den gewünschten Zugknopf auf Seite 358.
Varianti: per il lavello a filo top Vantis con pomolo standard Prime cromato, ordinate
xx.xxx.xx.01 – Articolo standard senza pomolo. Riduzione di CHF 24.–. In sostituzione, scegliete il pomolo desiderato a pagina 358.

Preis CHF/Prezzo in CHF

Modell Modello	Material Materiale	Ventil sFlow, Typ S Piletta sFlow, tipo S	Artikel-Nr. N. di articolo	Beckentiefe Profondità	Exkl. MWST IVA esclusa	Inkl. MWST IVA inclusa	VRG TRA		
Vantis V 50-42IF/12	Edelstahl, matt Acciaio inox, opaco	18/10	3 1/2" TouchFlow	10.104.236.00	175 mm	A	1201.–	1298.–	0.19
			3 1/2" Raumspär Salvaspazio	10.104.237.00	175 mm	A	1003.–	1084.–	
			3 1/2" Tipo	10.104.238.00	175 mm	A	954.–	1031.–	

Vantis: V 50-42IF/12

Randbreite 12 mm
Larghezza bordo 12 mm

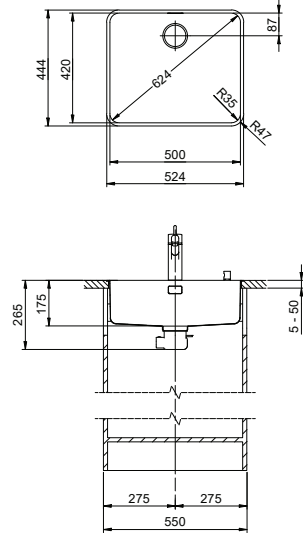

eFlow mit eControl
eFlow con eControl

Schwenkbare Überlaufkappe
Placchetta di troppopieno a ribalta

Desino: Verdeckter Ablauf mit untenliegendem Sieb
Desino: Scarico coperto con griglietta inferiore



Für eFlow Desino
Per eFlow Desino



Für TouchFlow Desino und Raumspaar Desino
Per TouchFlow Desino e Salvaspazio Desino



Für eFlow Desino, TouchFlow Desino und Raumspaar Desino
Per eFlow Desino, TouchFlow Desino e Salvaspazio Desino

Optionales Zubehör / Accessori opzionali

310



Resteschale gelocht
Vaschetta forato
CHF 106.– 40.000.914.00



Resteschale ungelocht
Vaschetta non forato
CHF 106.– 40.001.290.00



Schneidebrett aus Glas
Tagliere in vetro
CHF 151.– 40.000.915.00



Holz-Schneidebrett aus Nussbaum
Tagliere in legno di noce
CHF 151.– 40.001.147.00

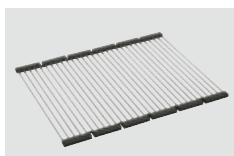

Inox Pad
CHF 125.– 40.001.138.00

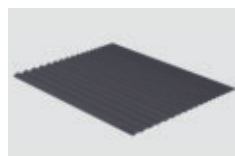

Maro Abtropfmatte aus Silikon
Maro tappetino scolapiatti in silicone
CHF 51.– 40.002.008.00

Zeichnung als pdf / dxf und Montageanleitung siehe:
V. disegno in formato pdf / dxf e montaggio:
suter.ch

Flächenbündiger Einbau: Empfehlung zur Wahl der Arbeitsplatte

Wir empfehlen den Einbau in Arbeitsplatten aus Keramik, Granit, Kunststein (z.B. Corian oder Varicor) oder Massivholz. Vom Einbau in beschichtete Spanplatten raten wir ab.

Montaggio a filo top: Consiglio per la scelta del piano di lavoro

Consigliamo il montaggio nei piani di lavoro in ceramica, granito, pietra artificiale (per es. Corian o Varicor) oppure in legno massiccio. Sconsigliamo la posa in pannelli di truciolato rivestiti.

1 Produktausführung, 2 Montagearten

Der besondere Vorteil von IF-Modellen: Sowohl der flächenbündige Einbau als auch der flach aufliegende Einbau ist möglich.

1 versione di prodotto, 2 metodi di montaggio

I modelli IF presentano un grande vantaggio: possono essere posati sia a filo top che sopra piano.

Preis CHF/Prezzo in CHF

Modell Modello	Material Materiale	Ventil sFlow, Typ M Piletta sFlow, tipo M	Artikel-Nr. N. di articolo	Beckentiefe Profondità	Exkl. MWST IVA esclusa	Inkl. MWST IVA inclusa	VRG TRA
Vantis V 50-42IF/12	Edelstahl, matt Acciaio inox, opaco	18/10	3 1/2" eFlow Desino	10.105.280.00	175 mm	A 1468.–	1587.– 0.19
			3 1/2" TouchFlow Desino	10.105.212.00	175 mm	A 1353.–	1463.– 0.19
			3 1/2" Raumspaar Desino Salvaspazio Desino	10.105.213.00	175 mm	A 1143.–	1236.–

Vantis: V 50-35IF/12

Randbreite 12 mm
Larghezza bordo 12 mm

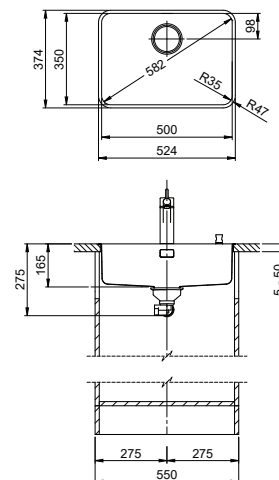

Schwenkbare Überlaufkappe
Placchetta di troppopieno a ribalta

Obenliegendes Sieb
Griglietta superiore

26



Zeichnung als pdf / dxf und Montageanleitung siehe:
V. disegno in formato pdf / dxf e montaggio:
suter.ch

Optionales Zubehör / Accessori opzionali

310

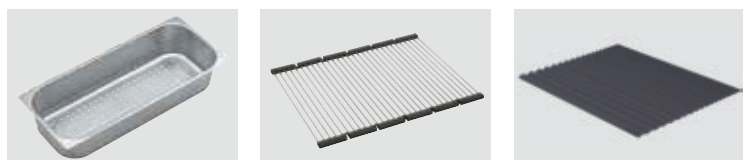

Resteschale gelocht
Vaschetta forato

CHF 106.– 40.000.916.00

Inox Pad

CHF 125.– 40.001.139.00

Maro Abtropfmatte aus Silikon
Maro tappetino scolapiatti in silicone

CHF 51.– 40.002.008.00

Flächenbündiger Einbau: Empfehlung zur Wahl der Arbeitsplatte

Wir empfehlen den Einbau in Arbeitsplatten aus Keramik, Granit, Kunststein (z.B. Corian oder Varicor) oder Massivholz. Vom Einbau in beschichtete Spanplatten raten wir ab.

Montaggio a filo top: Consiglio per la scelta del piano di lavoro

Consigliamo il montaggio nei piani di lavoro in ceramica, granito, pietra artificiale (per es. Corian o Varicor) oppure in legno massiccio. Sconsigliamo la posa in pannelli di truciolato rivestiti.

1 Produktausführung, 2 Montagearten

Der besondere Vorteil von IF-Modellen: Sowohl der flächenbündige Einbau als auch der flach aufliegende Einbau ist möglich.

1 versione di prodotto, 2 metodi di montaggio

I modelli IF presentano un grande vantaggio: possono essere posati sia a filo top che sopra piano.

Varianten: Für die flächenbündige Spüle Vantis mit Standard Zugknopf Prime Chrom bestellen Sie
xx.xxx.xx.01 Standardartikel ohne Zugknopf. Reduktion CHF 24.–. Im Austausch wählen Sie den gewünschten Zugknopf auf Seite 358.
Varianti: per il lavello a filo top Vantis con pomolo standard Prime cromato, ordinate
xx.xxx.xx.01 – Articolo standard senza pomolo. Riduzione di CHF 24.–. In sostituzione, scegliete il pomolo desiderato a pagina 358.

Preis CHF/Prezzo in CHF

Modell Modello	Material Materiale	Ventil sFlow, Typ S Piletta sFlow, tipo S	Artikel-Nr. N. di articolo	Beckentiefe Profondità	Exkl. MWST IVA esclusa	Inkl. MWST IVA inclusa	VRG TRA		
Vantis V 50-35IF/12	Edelstahl, matt Acciaio inox, opaco	18/10	3 1/2" TouchFlow	10.104.242.00	165 mm	A	1054.–	1139.–	0.19
			3 1/2" Raumspär Salvaspazio	10.104.243.00	165 mm	A	856.–	925.–	
			3 1/2" Tipo	10.104.244.00	165 mm	A	807.–	872.–	

Vantis: V 50-35IF/12

Randbreite 12 mm
Larghezza bordo 12 mm

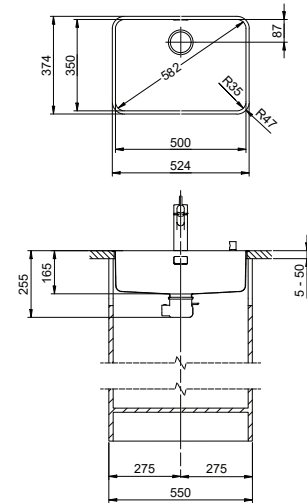

eFlow mit eControl
eFlow con eControl

Schwenkbare Überlaufkappe
Placchetta di troppopieno a ribalta

Desino: Verdeckter Ablauf mit untenliegendem Sieb
Desino: Scarico coperto con griglietta inferiore



Für eFlow Desino
Per eFlow Desino



Für TouchFlow Desino und Raumspaar Desino
Per TouchFlow Desino e Salvaspazio Desino



Für eFlow Desino, TouchFlow Desino und Raumspaar Desino
Per eFlow Desino, TouchFlow Desino e Salvaspazio Desino

Optionales Zubehör / Accessori opzionali

310



Resteschale gelocht
Vaschetta forato
CHF 106.– 40.000.916.00

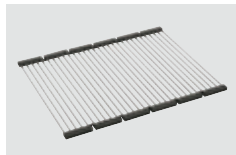

Inox Pad
CHF 125.– 40.001.139.00

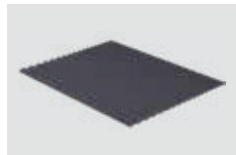

Maro Abtropfmatte aus Silikon
Maro tappetino scolapiatti in silicone
CHF 51.– 40.002.008.00

Zeichnung als pdf / dxf und Montageanleitung siehe:
V. disegno in formato pdf / dxf e montaggio:
suter.ch

Flächenbündiger Einbau: Empfehlung zur Wahl der Arbeitsplatte

Wir empfehlen den Einbau in Arbeitsplatten aus Keramik, Granit, Kunststein (z.B. Corian oder Varicor) oder Massivholz. Vom Einbau in beschichtete Spanplatten raten wir ab.

Montaggio a filo top: Consiglio per la scelta del piano di lavoro

Consigliamo il montaggio nei piani di lavoro in ceramica, granito, pietra artificiale (per es. Corian o Varicor) oppure in legno massiccio. Sconsigliamo la posa in pannelli di truciolato rivestiti.

1 Produktausführung, 2 Montagearten

Der besondere Vorteil von IF-Modellen: Sowohl der flächenbündige Einbau als auch der flach aufliegende Einbau ist möglich.

1 versione di prodotto, 2 metodi di montaggio

I modelli IF presentano un grande vantaggio: possono essere posati sia a filo top che sopra piano.

Preis CHF/Prezzo in CHF

Modell Modello	Material Materiale	Ventil sFlow, Typ M Piletta sFlow, tipo M	Artikel-Nr. N. di articolo	Beckentiefe Profondità	Exkl. MWST IVA esclusa	Inkl. MWST IVA inclusa	VRG TRA
Vantis V 50-35IF/12	Edelstahl, matt Acciaio inox, opaco	18/10	3 1/2" eFlow Desino	10.105.276.00	165 mm	A 1321.–	1428.– 0.19
			3 1/2" TouchFlow Desino	10.105.277.00	165 mm	A 1206.–	1304.– 0.19
			3 1/2" Raumspaar Desino Salvaspazio Desino	10.105.278.00	165 mm	A 996.–	1077.–

Vantis: V 55IF/12

Randbreite 12 mm
Larghezza bordo 12 mm

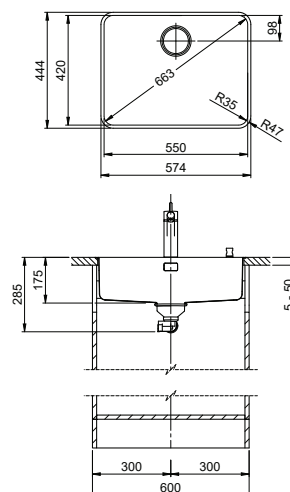

Schwenkbare Überlaufkappe
Placchetta di troppopieno a ribalta

Obenliegendes Sieb
Griglietta superiore

26



Zeichnung als pdf / dxf und Montageanleitung siehe:
V. disegno in formato pdf / dxf e montaggio:
suter.ch

Optionales Zubehör / Accessori opzionali

310



Resteschale gelocht
Vaschetta forata

CHF 106.– 40.000.914.00



Resteschale ungelocht
Vaschetta non forata

CHF 106.– 40.001.290.00



Schneidebrett aus Glas
Tagliere in vetro

CHF 151.– 40.000.915.00



Holz-Schneidebrett aus Nussbaum
Tagliere in legno di noce

CHF 151.– 40.001.147.00

Flächenbündiger Einbau: Empfehlung zur Wahl der Arbeitsplatte

Wir empfehlen den Einbau in Arbeitsplatten aus Keramik, Granit, Kunststein (z.B. Corian oder Varicor) oder Massivholz. Vom Einbau in beschichtete Spanplatten raten wir ab.

Montaggio a filo top: Consiglio per la scelta del piano di lavoro

Consigliamo il montaggio nei piani di lavoro in ceramica, granito, pietra artificiale (per es. Corian o Varicor) oppure in legno massiccio. Sconsigliamo la posa in pannelli di truciolato rivestiti.

1 Produktausführung, 2 Montagearten

Der besondere Vorteil von IF-Modellen: Sowohl der flächenbündige Einbau als auch der flach aufliegende Einbau ist möglich.

1 versione di prodotto, 2 metodi di montaggio

I modelli IF presentano un grande vantaggio: possono essere posati sia a filo top che sopra piano.

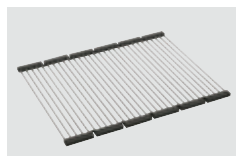

Inox Pad

CHF 125.– 40.001.138.00

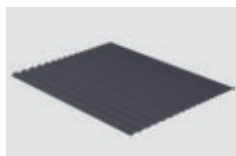

Maro Abtropfmatte aus Silikon
Maro tappetino scolapiatti in silicone

CHF 51.– 40.002.008.00

Varianten: Für die flächenbündige Spüle Vantis mit Standard Zugknopf Prime Chrom bestellen Sie
xx.xxx.xx.01 Standardartikel ohne Zugknopf. Reduktion CHF 24.–. Im Austausch wählen Sie den gewünschten Zugknopf auf Seite 358.
Varianti: per il lavello a filo top Vantis con pomolo standard Prime cromato, ordinate
xx.xxx.xx.01 – Articolo standard senza pomolo. Riduzione di CHF 24.–. In sostituzione, scegliete il pomolo desiderato a pagina 358.

Preis CHF/Prezzo in CHF

Modell Modello	Material Materiale	Ventil sFlow, Typ S Piletta sFlow, tipo S	Artikel-Nr. N. di articolo	Beckentiefe Profondità	Exkl. MWST IVA esclusa	Inkl. MWST IVA inclusa	VRG TRA		
Vantis V 55IF/12	Edelstahl, matt Acciaio inox, opaco	18/10	3 1/2" TouchFlow	10.104.248.00	175 mm	A	1432.–	1548.–	0.19
			3 1/2" Raumspär Salvaspazio	10.104.249.00	175 mm	A	1234.–	1334.–	
			3 1/2" Tipo	10.104.250.00	175 mm	A	1193.–	1290.–	

Vantis: V 55IF/12

Randbreite 12 mm
Larghezza bordo 12 mm

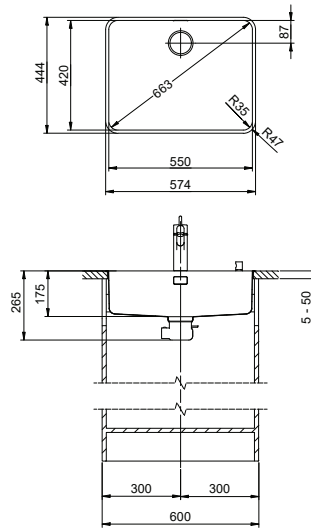

eFlow mit eControl
eFlow con eControl

Schwenkbare Überlaufkappe
Placchetta di troppopieno a ribalta

Desino: Verdeckter Ablauf mit untenliegendem Sieb
Desino: Scarico coperto con griglietta inferiore



Für eFlow Desino
Per eFlow Desino



Für TouchFlow Desino und Raumspaar Desino
Per TouchFlow Desino e Salvaspazio Desino



Für eFlow Desino, TouchFlow Desino und Raumspaar Desino
Per eFlow Desino, TouchFlow Desino e Salvaspazio Desino



Optionales Zubehör / Accessori opzionali

310



Resteschale gelocht
Vaschetta forato
CHF 106.– 40.000.914.00



Resteschale ungelocht
Vaschetta non forato
CHF 106.– 40.001.290.00



Schneidebrett aus Glas
Tagliere in vetro
CHF 151.– 40.000.915.00



Holz-Schneidebrett aus Nussbaum
Tagliere in legno di noce
CHF 151.– 40.001.147.00

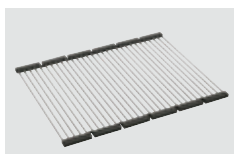

Inox Pad
CHF 125.– 40.001.138.00

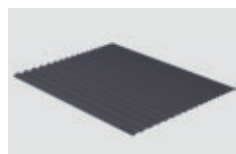

Maro Abtropfmatte aus Silikon
Maro tappetino scolapiatti in silicone
CHF 51.– 40.002.008.00

Zeichnung als pdf / dxf und Montageanleitung siehe:
V. disegno in formato pdf / dxf e montaggio:
suter.ch

Flächenbündiger Einbau: Empfehlung zur Wahl der Arbeitsplatte

Wir empfehlen den Einbau in Arbeitsplatten aus Keramik, Granit, Kunststein (z.B. Corian oder Varicor) oder Massivholz. Vom Einbau in beschichtete Spanplatten raten wir ab.

Montaggio a filo top: Consiglio per la scelta del piano di lavoro

Consigliamo il montaggio nei piani di lavoro in ceramica, granito, pietra artificiale (per es. Corian o Varicor) oppure in legno massiccio. Sconsigliamo la posa in pannelli di truciolato rivestiti.

1 Produktausführung, 2 Montagearten

Der besondere Vorteil von IF-Modellen: Sowohl der flächenbündige Einbau als auch der flach aufliegende Einbau ist möglich.

1 versione di prodotto, 2 metodi di montaggio

I modelli IF presentano un grande vantaggio: possono essere posati sia a filo top che sopra piano.

Varianten: Für die flächenbündige Spüle Vantis mit Standard Zugknopf Advant Chrom bestellen Sie xx.xxx.xx.01 Standardartikel ohne Zugknopf. Reduktion CHF 24.–. Im Austausch wählen Sie den gewünschten Zugknopf auf Seite 358.
Varianti: per il lavello a filo top Vantis con pomolo standard Advant cromato, ordinate xx.xxx.xx.01 – Articolo standard senza pomolo. Riduzione di CHF 24.–. In sostituzione, scegliete il pomolo desiderato a pagina 358.

Preis CHF/Prezzo in CHF

Modell Modèle	Material Materiale	Ventil sFlow, Typ M Piletta sFlow, tipo M	Artikel-Nr. No. d'articele	Beckentiefe Profondeur	Exkl. MWST Excl. TVA	Inkl. MWST Incl. TVA	VRG TRA
Vantis V 55IF/12	Edelstahl, matt Acciaio inox, opaco	18/10	3 1/2" eFlow Desino	10.105.281.00	175 mm	A 1699.–	1837.– 0.19
			3 1/2" TouchFlow Desino	10.105.214.00	175 mm	A 1584.–	1712.– 0.19
			3 1/2" Raumspaar Desino Salvaspazio Desino	10.105.215.00	175 mm	A 1374.–	1485.–

Vantis: VX 34IF/15 Varix

Randbreite 15 mm
Larghezza bordo 15 mm

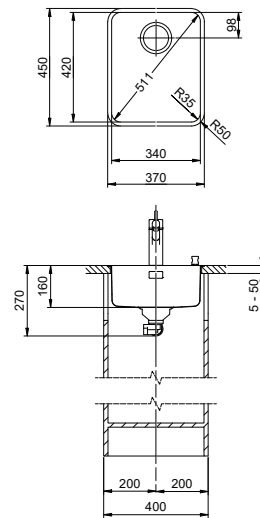

Verdeckter Überlauf
Trooppieno coperto



Zeichnung als pdf / dxf und Montageanleitung siehe:
V. disegno in formato pdf / dxf e montaggio:
suter.ch

Optionales Zubehör / Accessori opzionali



			
Resteschale gelocht Vaschetta forato	Resteschale ungelocht Vaschetta non forato	Schneidebrett aus Glas Tagliere in vetro	Schneidebrett aus Kunststoff Tagliere sintetico
CHF 106.– 40.000.914.00	CHF 106.– 40.001.290.00	CHF 151.– 40.000.915.00	CHF 151.– 40.001.147.00
			
Inox Pad	Maro Abtropfmatte aus Silikon Maro tappetino scolapiatti in silicone		
CHF 125.– 40.001.138.00	CHF 51.– 40.002.008.00		

Flächenbündiger Einbau: Empfehlung zur Wahl der Arbeitsplatte
Wir empfehlen den Einbau in Arbeitsplatten aus Keramik, Granit, Kunststein (z.B. Corian oder Varicor) oder Massivholz. Vom Einbau in beschichtete Spanplatten raten wir ab.

Montaggio a filo top: Consiglio per la scelta del piano di lavoro
Consigliamo il montaggio nei piani di lavoro in ceramica, granito, pietra artificiale (per es. Corian o Varicor) oppure in legno massiccio. Sconsigliamo la posa in pannelli di truciolato rivestiti.

1 Produktausführung, 2 Montagearten
Der besondere Vorteil von IF-Modellen: Sowohl der flächenbündige Einbau als auch der flach aufliegende Einbau ist möglich.

1 versione di prodotto, 2 metodi di montaggio
I modelli IF presentano un grande vantaggio: possono essere posati sia a filo top che sopra piano.

Preis CHF / Prezzo in CHF

Modell Modello	Material Materiale	Ventil Piletta	Artikel-Nr. N. di articolo	Beckentiefe Profondità	Exkl. MWST IVA esclusa	Inkl. MWST IVA inclusa
Vantis VX 34IF/15 Varix	Edelstahl, mid-matt Acciaio inox, mid-matt	18/10 3 1/2" Raumspar Salvaspazio	10.105.252.00	160 mm	A 706.–	763.–
		3 1/2" Siebstopfen A tappo con griglietta	10.105.253.00	160 mm	A 665.–	719.–

Vantis: VX 40IF/15 Varix

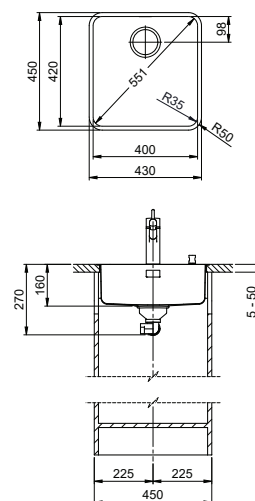
Randbreite 15 mm
Larghezza bordo 15 mm

 Verdeckter Überlauf
Troppopieno coperto

27

 Zeichnung als pdf / dxf und Montageanleitung siehe:
 V. disegno in formato pdf / dxf e montaggio:
 suter.ch

Optionales Zubehör / Accessori opzionali

310

Resteschale gelocht
Vaschetta forata

CHF 106.– 40.000.914.00

Resteschale ungelocht
Vaschetta non forata

CHF 106.– 40.001.290.00

Schneidebrett aus Glas
Tagliere in vetro

CHF 151.– 40.000.915.00

Schneidebrett aus Kunststoff
Tagliere sintetico

CHF 151.– 40.001.147.00

Flächenbündiger Einbau: Empfehlung zur Wahl der Arbeitsplatte

Wir empfehlen den Einbau in Arbeitsplatten aus Keramik, Granit, Kunststein (z.B. Corian oder Varicor) oder Massivholz. Vom Einbau in beschichtete Spanplatten raten wir ab.

Montaggio a filo top: Consiglio per la scelta del piano di lavoro

Consigliamo il montaggio nei piani di lavoro in ceramica, granito, pietra artificiale (per es. Corian o Varicor) oppure in legno massiccio. Sconsigliamo la posa in pannelli di truciolato rivestiti.

1 Produktausführung, 2 Montagearten

Der besondere Vorteil von IF-Modellen: Sowohl der flächenbündige Einbau als auch der flach aufliegende Einbau ist möglich.

1 versione di prodotto, 2 metodi di montaggio

I modelli IF presentano un grande vantaggio: possono essere posati sia a filo top che sopra piano.

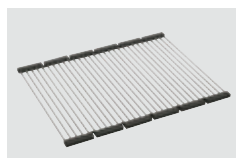
Inox Pad

CHF 125.– 40.001.138.00

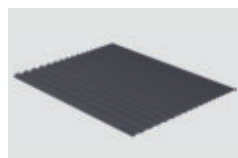
Maro Abtropfmatte aus Silikon
Maro tappetino scolapiatti in silicone

CHF 51.– 40.002.008.00

Varianten: Für die flächenbündige Spüle Vantis mit Standard Zugknopf Prime Chrom bestellen Sie

xx.xxx.xx.01 Standardartikel ohne Zugknopf. Reduktion CHF 24.–. Im Austausch wählen Sie den gewünschten Zugknopf auf Seite 358.

Varianti: per il lavello a filo top Vantis con pomolo standard Prime cromato, ordinate

xx.xxx.xx.01 – Articolo standard senza pomolo. Riduzione di CHF 24.–. In sostituzione, scegliete il pomolo desiderato a pagina 358.

Preis CHF / Prezzo in CHF

Modell Modello	Material Materiale	Ventil Piletta	Artikel-Nr. N. di articolo	Beckentiefe Profondità	Exkl. MWST IVA esclusa	Inkl. MWST IVA inclusa
Vantis VX 40IF/15 Varix	Edelstahl, mid-matt Acciaio inox, mid-matt	18 / 10 3 1/2" Raumspar Salvaspazio	10.104.155.00	160 mm	A 744.–	804.–
		3 1/2" Siebstopfen A tappo con griglietta	10.104.156.00	160 mm	A 703.–	760.–

Vantis : VX 45IF/15 Varix

Randbreite 15 mm
Larghezza bordo 15 mm

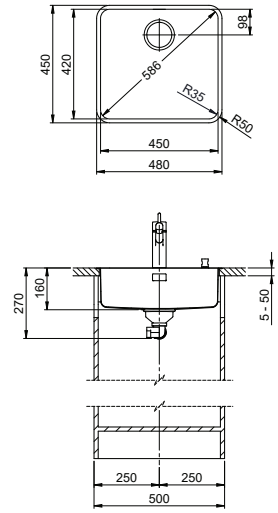

Verdeckter Überlauf
Troppopieno coperto



Zeichnung als pdf / dxf und Montageanleitung siehe:
V. disegno in formato pdf / dxf e montaggio:
suter.ch

Optionales Zubehör / Accessori opzionali



Resteschale gelocht Vaschetta forato	Resteschale ungelocht Vaschetta non forato	Schneidebrett aus Glas Tagliere in vetro	Schneidebrett aus Kunststoff Tagliere sintetico
CHF 106.– 40.000.914.00	CHF 106.– 40.001.290.00	CHF 151.– 40.000.915.00	CHF 151.– 40.001.147.00
Inox Pad	Maro Abtropfmatte aus Silikon Maro tappetino scolapiatti in silicone		
CHF 125.– 40.001.138.00	CHF 51.– 40.002.008.00		

Flächenbündiger Einbau: Empfehlung zur Wahl der Arbeitsplatte

Wir empfehlen den Einbau in Arbeitsplatten aus Keramik, Granit, Kunststein (z.B. Corian oder Varicor) oder Massivholz. Vom Einbau in beschichtete Spanplatten raten wir ab.

Montaggio a filo top: Consiglio per la scelta del piano di lavoro

Consigliamo il montaggio nei piani di lavoro in ceramica, granito, pietra artificiale (per es. Corian o Varicor) oppure in legno massiccio. Sconsigliamo la posa in pannelli di truciolato rivestiti.

1 Produktausführung, 2 Montagearten

Der besondere Vorteil von IF-Modellen: Sowohl der flächenbündige Einbau als auch der flach aufliegende Einbau ist möglich.

1 versione di prodotto, 2 metodi di montaggio

I modelli IF presentano un grande vantaggio: possono essere posati sia a filo top che sopra piano.

Varianten: Für die flächenbündige Spüle Vantis mit Standard Zugknopf Prime Chrom bestellen Sie
xx.xxx.xx.01 Standardartikel ohne Zugknopf. Reduktion CHF 24.–. Im Austausch wählen Sie den gewünschten Zugknopf auf Seite 358.
Varianti: per il lavello a filo top Vantis con pomolo standard Prime cromato, ordinate
xx.xxx.xx.01 – Articolo standard senza pomolo. Riduzione di CHF 24.–. In sostituzione, scegliete il pomolo desiderato a pagina 358.

Preis CHF / Prezzo in CHF

Modell Modello	Material Materiale	Ventil Piletta	Artikel-Nr. N. di articolo	Beckentiefe Profondità	Exkl. MWST IVA esclusa	Inkl. MWST IVA inclusa
Vantis VX 45IF/15 Varix	Edelstahl, mid-matt Acciaio inox, mid-matt	18 / 10	3 1/2" Raumspar Salvaspazio	10.104.157.00	160 mm	A 777.– 840.–
		3 1/2" Siebstopfen A tappo con griglietta	10.104.158.00	160 mm	A 736.– 796.–	

Vantis : VX 50-42IF/15 Varix

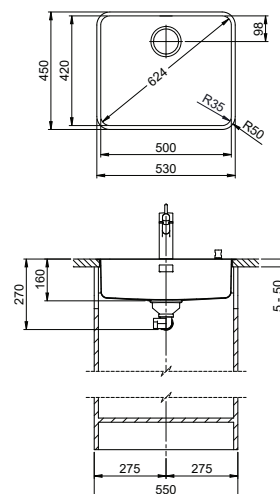
Randbreite 15 mm
Larghezza bordo 15 mm

 Verdeckter Überlauf
Troppopieno coperto

27

 Zeichnung als pdf / dxf und Montageanleitung siehe:
 V. disegno in formato pdf / dxf e montaggio:
 suter.ch

Optionales Zubehör / Accessori opzionali

310

Resteschale gelocht
Vaschetta forato
 CHF 106.– 40.000.914.00

Resteschale ungelocht
Vaschetta non forato
 CHF 106.– 40.001.290.00

Schneidebrett aus Glas
Tagliere in vetro
 CHF 151.– 40.000.915.00

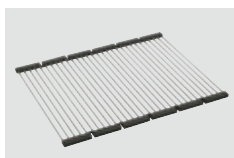
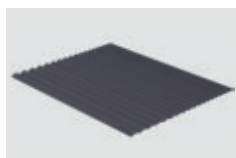
Schneidebrett aus Kunststoff
Tagliere sintetico
 CHF 151.– 40.001.147.00

Inox Pad
 CHF 125.– 40.001.138.00

Maro Abtropfmatte aus Silikon
Maro tappetino scolapiatti in silicone
 CHF 51.– 40.002.008.00

Flächenbündiger Einbau: Empfehlung zur Wahl der Arbeitsplatte

Wir empfehlen den Einbau in Arbeitsplatten aus Keramik, Granit, Kunststein (z.B. Corian oder Varicor) oder Massivholz. Vom Einbau in beschichtete Spanplatten raten wir ab.

Montaggio a filo top: Consiglio per la scelta del piano di lavoro

Consigliamo il montaggio nei piani di lavoro in ceramica, granito, pietra artificiale (per es. Corian o Varicor) oppure in legno massiccio. Sconsigliamo la posa in pannelli di truciolato rivestiti.

1 Produktausführung, 2 Montagearten

Der besondere Vorteil von IF-Modellen: Sowohl der flächenbündige Einbau als auch der flach aufliegende Einbau ist möglich.

1 versione di prodotto, 2 metodi di montaggio

I modelli IF presentano un grande vantaggio: possono essere posati sia a filo top che sopra piano.

Varianten: Für die flächenbündige Spüle Vantis mit Standard Zugknopf Prime Chrom bestellen Sie
 xx.xxx.xx.01 Standardartikel ohne Zugknopf. Reduktion CHF 24.–. Im Austausch wählen Sie den gewünschten Zugknopf auf Seite 358.
Varianti: per il lavello a filo top Vantis con pomolo standard Prime cromato, ordinate
 xx.xxx.xx.01 – Articolo standard senza pomolo. Riduzione di CHF 24.–. In sostituzione, scegliete il pomolo desiderato a pagina 358.

Preis CHF / Prezzo in CHF

Modell Modello	Material Materiale	Ventil Piletta	Artikel-Nr. N. di articolo	Beckentiefe Profondità	Exkl. MWST IVA esclusa	Inkl. MWST IVA inclusa
Vantis VX 50-42IF/15 Varix	Edelstahl, mid-matt Acciaio inox, mid-matt	3 1/2" Raumspar Salvaspazio	10.104.159.00	160 mm	A 793.–	857.–
		3 1/2" Siebstopfen A tappo con griglietta	10.104.160.00	160 mm	A 752.–	813.–

Vantis : VX 55IF/15 Varix

Randbreite 15 mm
Larghezza bordo 15 mm

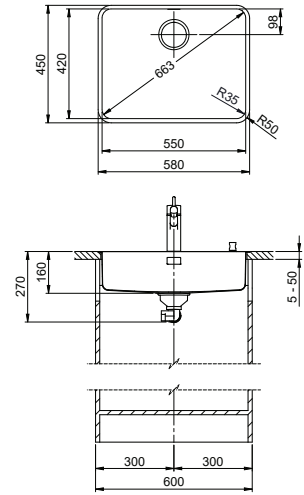

Verdeckter Überlauf
Troppopieno coperto



Zeichnung als pdf / dxf und Montageanleitung siehe:
V. disegno in formato pdf / dxf e montaggio:
suter.ch

Optionales Zubehör / Accessori opzionali



Resteschale gelocht Vaschetta forata	Resteschale ungelocht Vaschetta non forata	Schneidebrett aus Glas Tagliere in vetro	Schneidebrett aus Kunststoff Tagliere sintetico
CHF 106.– 40.000.914.00	CHF 106.– 40.001.290.00	CHF 151.– 40.000.915.00	CHF 151.– 40.001.147.00
Inox Pad	Maro Abtropfmatte aus Silikon Maro tappetino scolapiatti in silicone		
CHF 125.– 40.001.138.00	CHF 51.– 40.002.008.00		

Flächenbündiger Einbau: Empfehlung zur Wahl der Arbeitsplatte
Wir empfehlen den Einbau in Arbeitsplatten aus Keramik, Granit, Kunststein (z.B. Corian oder Varicor) oder Massivholz. Vom Einbau in beschichtete Spanplatten raten wir ab.

Montaggio a filo top: Consiglio per la scelta del piano di lavoro
Consigliamo il montaggio nei piani di lavoro in ceramica, granito, pietra artificiale (per es. Corian o Varicor) oppure in legno massiccio. Sconsigliamo la posa in pannelli di truciolato rivestiti.

1 Produktausführung, 2 Montagearten
Der besondere Vorteil von IF-Modellen: Sowohl der flächenbündige Einbau als auch der flach aufliegende Einbau ist möglich.

1 versione di prodotto, 2 metodi di montaggio
I modelli IF presentano un grande vantaggio: possono essere posati sia a filo top che sopra piano.

! Varianten: Für die flächenbündige Spüle Vantis mit Standard Zugknopf Prime Chrom bestellen Sie
xx.xxx.xx.01 Standardartikel ohne Zugknopf. Reduktion CHF 24.–. Im Austausch wählen Sie den gewünschten Zugknopf auf Seite 358.
Varianti: per il lavello a filo top Vantis con pomolo standard Prime cromato, ordinate
xx.xxx.xx.01 – Articolo standard senza pomolo. Riduzione di CHF 24.–. In sostituzione, scegliete il pomolo desiderato a pagina 358.

Preis CHF / Prezzo in CHF

Modell Modello	Material Materiale	Ventil Piletta	Artikel-Nr. N. di articolo	Beckentiefe Profondità	Exkl. MWST IVA esclusa	Inkl. MWST IVA inclusa
Vantis VX 55IF/15 Varix	Edelstahl, mid-matt Acciaio inox, mid-matt	18 / 10 3 1/2" Raumspar Salvaspazio	10.104.161.00	160 mm	A 857.–	926.–
		3 1/2" Siebstopfen A tappo con griglietta	10.104.162.00	160 mm	A 816.–	882.–

Silver Star: SIL 45IF/12

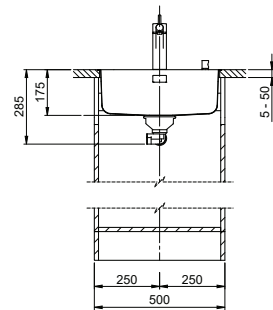
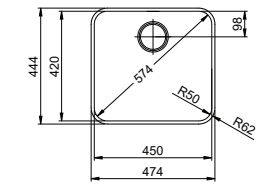
Randbreite 12 mm
Larghezza bordo 12 mm

 Verdeckter Überlauf
Tropppieno coperto

27

 Obenliegendes Sieb
Griglietta superiore

26

 Zeichnung als pdf / dxf und Montageanleitung siehe:
V. disegno in formato pdf / dxf e montaggio:
suter.ch

Optionales Zubehör / Accessori opzionali

310

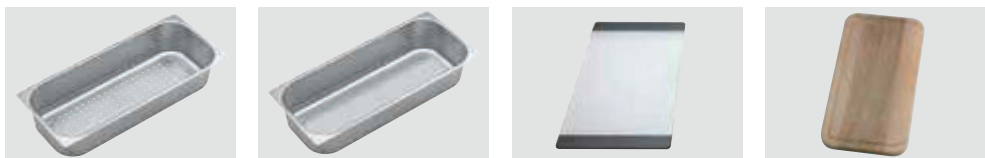
Resteschale gelocht
Vaschetta forato

CHF 106.– 40.000.914.00

Resteschale ungelocht
Vaschetta non forato

CHF 106.– 40.001.290.00

Schneidebrett aus Glas
Tagliere in vetro

CHF 151.– 40.000.915.00

Schneidebrett aus Kunststoff
Tagliere sintetico

CHF 151.– 40.001.147.00

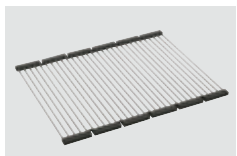
**Innox Pad**

CHF 125.– 40.001.138.00

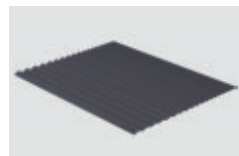
Maro Abtropfmatte aus Silikon
Maro tappetino scolapiatti in silicone

CHF 51.– 40.002.008.00

Wählen Sie den Oberflächenfinish:

In den Ausführungen glanz und matt erhältlich.

Scegliete la finitura:

Disponibile nelle finiture lucido e opaco.

Flächenbündiger Einbau: Empfehlung zur Wahl der Arbeitsplatte

Wir empfehlen den Einbau in Arbeitsplatten aus Keramik, Granit, Kunststein (z.B. Corian oder Varicor) oder Massivholz. Vom Einbau in beschichtete Spanplatten raten wir ab.

Montaggio a filo top: Consiglio per la scelta del piano di lavoro

Consigliamo il montaggio nei piani di lavoro in ceramica, granito, pietra artificiale (per es. Corian o Varicor) oppure in legno massiccio. Sconsigliamo la posa in pannelli di truciolato rivestiti.

1 Produktausführung, 2 Montagearten

Der besondere Vorteil von IF-Modellen: Sowohl der flächenbündige Einbau als auch der flach aufliegende Einbau ist möglich.

1 versione di prodotto, 2 metodi di montaggio

I modelli IF presentano un grande vantaggio: possono essere posati sia a filo top che soprapiano.

Varianten: Für die flächenbündige Spüle Silver Star mit Standard Zugknopf Prime Chrom bestellen Sie
xx.xxx.xx.01 Standardartikel ohne Zugknopf. Reduktion CHF 24.–. Im Austausch wählen Sie den gewünschten Zugknopf auf Seite 358.
Varianti: per il lavello a filo top Silver Star con pomolo standard Prime cromato, ordinate
xx.xxx.xx.01 – Articolo standard senza pomolo. Riduzione di CHF 24.–. In sostituzione, scegliete il pomolo desiderato a pagina 358.

Preis CHF/Prezzo in CHF

Modell Modello	Material Materiale	Ventil Piletta	Artikel-Nr. N. di articolo	Beckentiefe Profondità	Exkl. MWST IVA esclusa	Inkl. MWST IVA inclusa
Silver Star SIL 45IF/12	Edelstahl, matt Acciaio inox, opaco	18/10 3 1/2" Raumspar Extra plate	10.104.255.00	175 mm	A 897.–	970.–
		3 1/2" Tipo	10.104.256.00	175 mm	A 848.–	917.–
	Edelstahl, glanz Acciaio inox, lucido	18/10 3 1/2" Raumspar Extra plate	10.104.252.00	175 mm	A 897.–	970.–
		3 1/2" Tipo	10.104.253.00	175 mm	A 848.–	917.–

Silver Star: SIS 50IF/12

Randbreite 12 mm
Larghezza bordo 12 mm

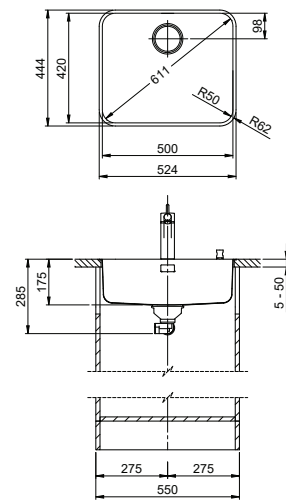

Verdeckter Überlauf
Trooppieno coperto

Obenliegendes Sieb
Griglietta superiore



Zeichnung als pdf / dxf und Montageanleitung siehe:
V. disegno in formato pdf / dxf e montaggio:
suter.ch

Optionales Zubehör / Accessori opzionali

Resteschale gelocht Vaschetta forata CHF 106.– 40.000.914.00	Resteschale ungelocht Vaschetta non forata CHF 106.– 40.001.290.00	Schneidebrett aus Glas Tagliere in vetro CHF 151.– 40.000.915.00	Schneidebrett aus Kunststoff Tagliere sintetico CHF 151.– 40.001.147.00
Inox Pad CHF 125.– 40.001.138.00	Maro Abtropfmatte aus Silikon Maro tappetino scolapiatti in silicone CHF 51.– 40.002.008.00		

Wählen Sie den Oberflächenfinish:
In den Ausführungen glanz und matt erhältlich.

Scegliete la finitura:
Disponibile nelle finiture lucido e opaco.

Flächenbündiger Einbau: Empfehlung zur Wahl der Arbeitsplatte
Wir empfehlen den Einbau in Arbeitsplatten aus Keramik, Granit, Kunststein (z.B. Corian oder Varicor) oder Massivholz. Vom Einbau in beschichtete Spanplatten raten wir ab.

Montaggio a filo top: Consiglio per la scelta del piano di lavoro
Consigliamo il montaggio nei piani di lavoro in ceramica, granito, pietra artificiale (per es. Corian o Varicor) oppure in legno massiccio. Sconsigliamo la posa in pannelli di truciolato rivestiti.

1 Produktausführung, 2 Montagearten
Der besondere Vorteil von IF-Modellen: Sowohl der flächenbündige Einbau als auch der flach aufliegende Einbau ist möglich.

1 versione di prodotto, 2 metodi di montaggio
I modelli IF presentano un grande vantaggio: possono essere posati sia a filo top che sopra piano.

Varianten: Für die flächenbündige Spüle Silver Star mit Standard Zugknopf Prime Chrom bestellen Sie
xx.xxx.xx.01 Standardartikel ohne Zugknopf. Reduktion CHF 24.–. Im Austausch wählen Sie den gewünschten Zugknopf auf Seite 358.
Varianti: per il lavello a filo top Silver Star con pomolo standard Prime cromato, ordinate
xx.xxx.xx.01 – Articolo standard senza pomolo. Riduzione di CHF 24.–. In sostituzione, scegliete il pomolo desiderato a pagina 358.

Preis CHF/Prezzo in CHF

Modell Modello	Material Materiale	Ventil Piletta	Artikel-Nr. N. di articolo	Beckentiefe Profondità	Exkl. MWST IVA esclusa	Inkl. MWST IVA inclusa
Silver Star SIS 50IF/12	Edelstahl, matt Acciaio inox, opaco	3 1/2" Raumspar Extra plate	10.104.263.00	175 mm	A 1003.–	1084.–
		3 1/2" Tipo	10.104.264.00	175 mm	A 954.–	1031.–
	Edelstahl, glanz Acciaio inox, lucido	3 1/2" Raumspar Extra plate	10.104.260.00	175 mm	A 1003.–	1084.–
		3 1/2" Tipo	10.104.261.00	175 mm	A 954.–	1031.–

Silver Star: SIL 55IF/12

Randbreite 12 mm
Larghezza bordo 12 mm

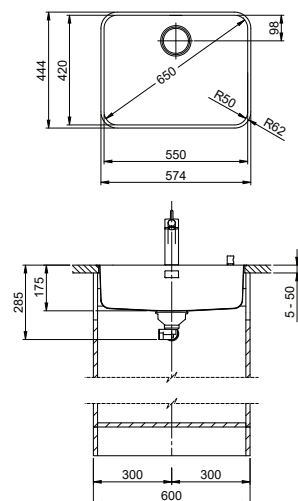

Verdeckter Überlauf
Troppopieno coperto

27 Obenliegendes Sieb
Griglietta superiore

26



Zeichnung als pdf / dxf und Montageanleitung siehe:
V. disegno in formato pdf / dxf e montaggio:
suter.ch

Optionales Zubehör / Accessori opzionali

310

			
Resteschale gelocht Vaschetta forato CHF 106.– 40.000.914.00	Resteschale ungelocht Vaschetta non forato CHF 106.– 40.001.290.00	Schneidebrett aus Glas Tagliere in vetro CHF 151.– 40.000.915.00	Schneidebrett aus Kunststoff Tagliere sintetico CHF 151.– 40.001.147.00
			
Inox Pad CHF 125.– 40.001.138.00	Maro Abtropfmatte aus Silikon Maro tappetino scolapiatti in silicone CHF 51.– 40.002.008.00		

Wählen Sie den Oberflächenfinish:
In den Ausführungen glanz und matt erhältlich.
Scegliete la finitura:
Disponibile nelle finiture lucido e opaco.
Flächenbündiger Einbau: Empfehlung zur Wahl der Arbeitsplatte
Wir empfehlen den Einbau in Arbeitsplatten aus Keramik, Granit, Kunststein (z.B. Corian oder Varicor) oder Massivholz. Vom Einbau in beschichtete Spanplatten raten wir ab.
Montaggio a filo top: Consiglio per la scelta del piano di lavoro
Consigliamo il montaggio nei piani di lavoro in ceramica, granito, pietra artificiale (per es. Corian o Varicor) oppure in legno massiccio. Sconsigliamo la posa in pannelli di truciolato rivestiti.

1 Produktausführung, 2 Montagearten
Der besondere Vorteil von IF-Modellen: Sowohl der flächenbündige Einbau als auch der flach aufliegende Einbau ist möglich.
1 versione di prodotto, 2 metodi di montaggio
I modelli IF presentano un grande vantaggio: possono essere posati sia a filo top che sopra piano.

! **Varianten: Für die flächenbündige Spüle Silver Star mit Standard Zugknopf Prime Chrom bestellen Sie**
xx.xxx.xx.01 Standardartikel ohne Zugknopf. Reduktion CHF 24.–. Im Austausch wählen Sie den gewünschten Zugknopf auf Seite 358.
Varianti: per il lavello a filo top Silver Star con pomolo standard Prime cromato, ordinate
xx.xxx.xx.01 – Articolo standard senza pomolo. Riduzione di CHF 24.–. In sostituzione, scegliete il pomolo desiderato a pagina 358.

Preis CHF/Prezzo in CHF

Modell Modello	Material Materiale	Ventil Piletta	Artikel-Nr. N. di articolo	Beckentiefe Profondità	Exkl. MWST IVA esclusa	Inkl. MWST IVA inclusa
Silver Star SIL 55IF/12	Edelstahl, matt Acciaio inox, opaco	18/10 3 1/2" Raumspar Extra plate	10.104.269.00	175 mm	A 1234.–	1334.–
		3 1/2" Tipo	10.104.270.00	175 mm	A 1193.–	1290.–
	Edelstahl, glanz Acciaio inox, lucido	18/10 3 1/2" Raumspar Extra plate	10.104.266.00	175 mm	A 1234.–	1334.–
		3 1/2" Tipo	10.104.267.00	175 mm	A 1193.–	1290.–

Accento: A 65IF/12

Randbreite 12 mm
Larghezza bordo 12 mm

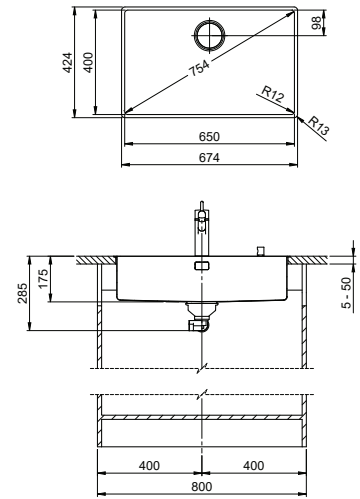
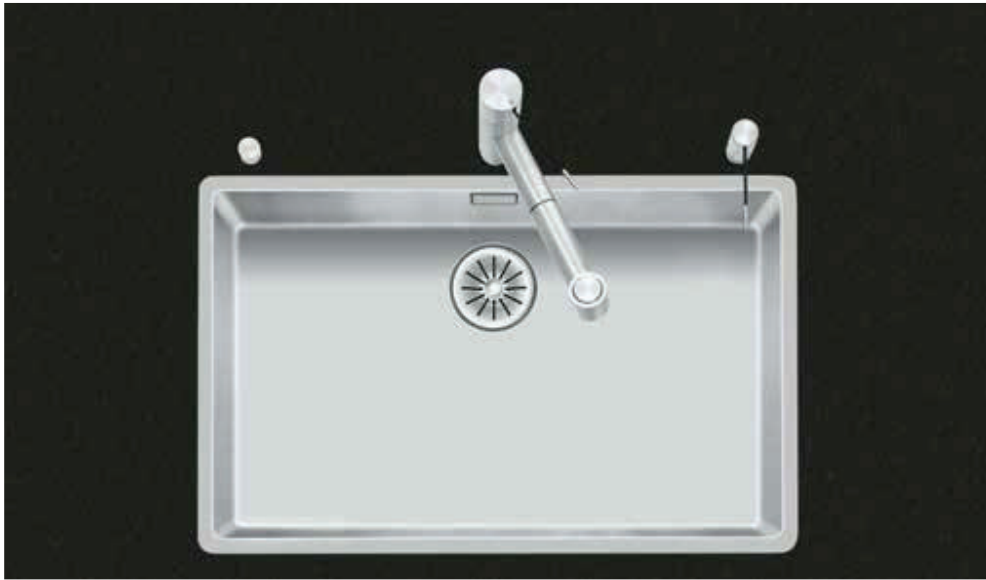

Schwenkbare Überlaufkappe
Placchetta di troppopieno a ribalta

Obenliegendes Sieb
Griglietta superiore

26



Zeichnung als pdf / dxf und Montageanleitung siehe:
V. disegno in formato pdf / dxf e montaggio:
suter.ch

Optionales Zubehör / Accessori opzionali

310

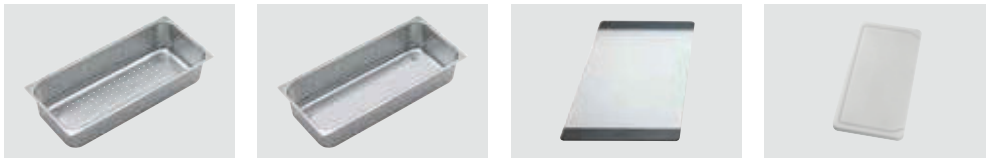

Resteschale gelocht
Vaschetta forata
CHF 106.– 40.000.912.00

Resteschale ungelocht
Vaschetta non forata
CHF 106.– 40.001.289.00

Schneidebrett aus Glas
Tagliere in vetro
CHF 151.– 40.000.909.00

Schneidebrett aus Kunststoff
Tagliere sintetico
CHF 151.– 40.001.277.00

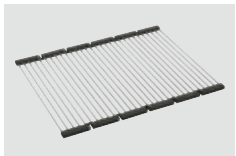

Inox Pad
CHF 125.– 40.001.138.00

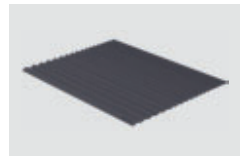

Maro Abtropfmatte aus Silikon
Maro tappetino scolapiatti in silicone
CHF 51.– 40.002.008.00

Alle Accento Modelle werden handgefertigt
Tutti i modelli Accento sono fabbricati a mano

Flächenbündiger Einbau: Empfehlung zur Wahl der Arbeitsplatte

Wir empfehlen den Einbau in Arbeitsplatten aus Keramik, Granit, Kunststein (z.B. Corian oder Varicor) oder Massivholz. Vom Einbau in beschichtete Spanplatten raten wir ab.

Montaggio a filo top: Consiglio per la scelta del piano di lavoro

Consigliamo il montaggio nei piani di lavoro in ceramica, granito, pietra artificiale (per es. Corian o Varicor) oppure in legno massiccio. Sconsigliamo la posa in pannelli di truciolato rivestiti.

1 Produktausführung, 2 Montagearten

Der besondere Vorteil von IF-Modellen: Sowohl der flächenbündige Einbau als auch der flach aufliegende Einbau ist möglich.

1 versione di prodotto, 2 metodi di montaggio

I modelli IF presentano un grande vantaggio: possono essere posati sia a filo top che sopra piano.

Varianten: Für die flächenbündige Spüle Accento mit Standard Zugknopf Advant Chrom bestellen Sie
xx.xxx.xx.01 Standardartikel ohne Zugknopf. Reduktion CHF 24.–. Im Austausch wählen Sie den gewünschten Zugknopf auf Seite 358.
Varianti: per il lavello a filo top Accento con pomolo standard Advant cromato, ordinate
xx.xxx.xx.01 – Articolo standard senza pomolo. Riduzione di CHF 24.–. In sostituzione, scegliete il pomolo desiderato a pagina 358.

Preis CHF/Prezzo in CHF

Modell Modello	Material Materiale	Ventil Piletta	Artikel-Nr. N. di articolo	Beckentiefe Profondità	Exkl. MWST IVA esclusa	Inkl. MWST IVA inclusa	VRG TRA
Accento A 65IF/12	Edelstahl, glanz Acciaio inox, lucido	18/10	3 1/2" TouchFlow	10.104.546.00	175 mm	A 2146.–	2320.– 0.19
			3 1/2" Raumspaar Salvaspazio	10.104.547.00	175 mm	A 1948.–	2106.–
			3 1/2" Tipo	10.104.548.00	175 mm	A 1907.–	2061.–

Linero: LIO CD 50F/17

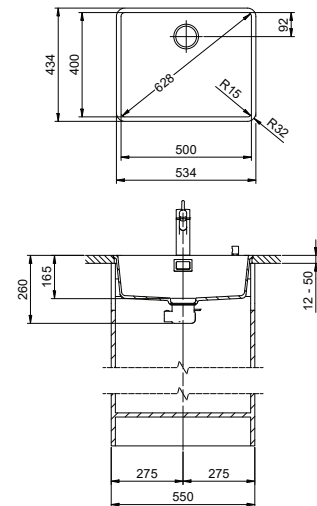
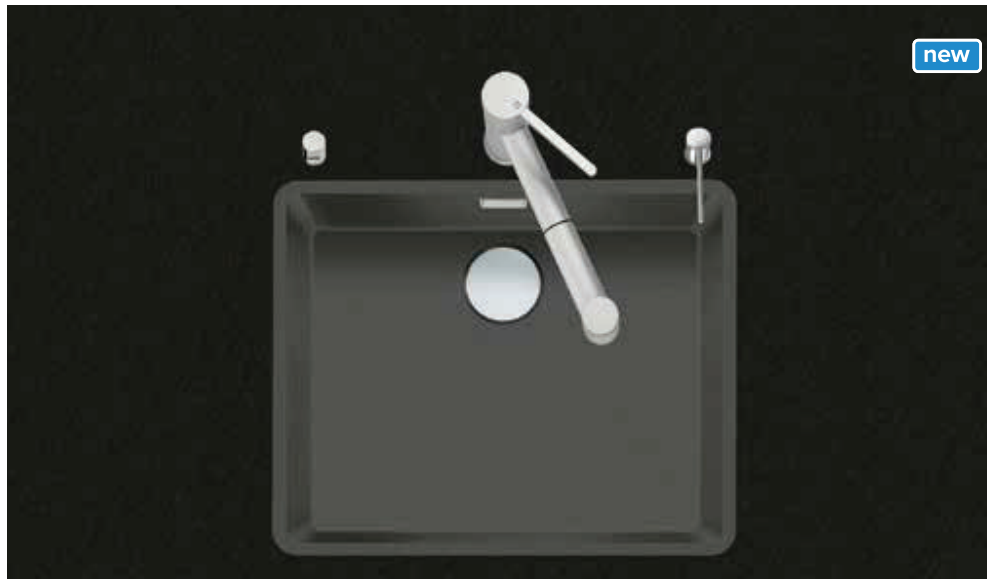
Randbreite 17 mm
Larghezza bordo 17 mm**SCHOCK**
CRISTADUR®

 Schwenkbare Überlaufkappe
Placchetta di troppopieno a ribalta

27

 Desino: Verdeckter Ablauf mit untenliegendem Sieb
Desino: Scarico coperto con griglietta inferiore

26

Für TouchFlow Desino und Raumspar Desino
Per TouchFlow Desino e Salvaspazio DesinoFür TouchFlow Desino und Raumspar Desino
Per TouchFlow Desino e Salvaspazio DesinoZeichnung als pdf / dxf und Montageanleitung siehe:
V. disegno in formato pdf / dxf e montaggio:
suter.ch

Optionales Zubehör / Accessori opzionali

310

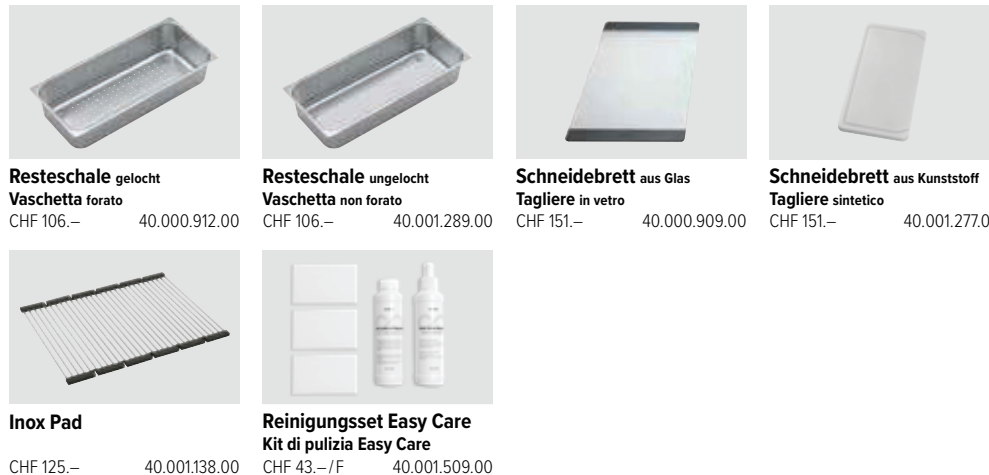
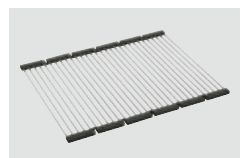
**Resteschale** gelocht
Vaschetta forata
CHF 106.– 40.000.912.00**Resteschale** ungelocht
Vaschetta non forata
CHF 106.– 40.001.289.00**Schneidebrett** aus Glas
Tagliere in vetro
CHF 151.– 40.000.909.00**Schneidebrett** aus Kunststoff
Tagliere sintetico
CHF 151.– 40.001.277.00**Inox Pad**
CHF 125.– 40.001.138.00**Reinigungsset Easy Care**
Kit di pulizia Easy Care
CHF 43.–/F 40.001.509.00**Nur für flächenbündigen Einbau erhältlich.**
Disponibile solo per montaggio a filo top.**Flächenbündiger Einbau: Empfehlung zur Wahl der Arbeitsplatte**

Wir empfehlen den Einbau in Arbeitsplatten aus Keramik, Granit, Kunststein (z.B. Corian oder Varicor) oder Massivholz. Vom Einbau in beschichtete Spanplatten raten wir ab.

Montaggio a filo top: Consiglio per la scelta del piano di lavoro

Consigliamo il montaggio nei piani di lavoro in ceramica, granito, pietra artificiale (per es. Corian o Varicor) oppure in legno massiccio. Sconsigliamo la posa in pannelli di truciolato rivestiti.

**Mehrpriß für beschichtete Ventilbestandteile**
TouchFlow Desino und Raumspar Desino: Ablaufsieb Desino, Überlaufblende und Überlaufkappe**Sovraprezzo per componenti piletta rivestiti**
TouchFlow Desino e Salvaspazio Desino: griglietta per lo scarico Desino, mascherina e tappo di troppopieno**PVD-Beschichtung, Graphit**
Rivestimento a PVD, grafite
3 1/2" TouchFlow

CHF 125.–/F 40.002.788.02

**PVD-Beschichtung, Graphit**
Rivestimento a PVD, grafite
3 1/2" Raumspar Desino/ Salvaspazio Desino

CHF 125.–/F 40.002.767.02









**DEC-Beschichtung, schwarz matt**
Rivestimento a DEC, nero opaco
3 1/2" TouchFlow Desino

CHF 140.–/F 40.002.789.02

**DEC-Beschichtung, schwarz matt**
Rivestimento a DEC, nero opaco
3 1/2" Raumspar Desino/ Salvaspazio Desino

CHF 140.–/F 40.002.768.02

Preis CHF/Prezzo in CHF

Modell Modello	Material Materiale	Ventil sFlow, Typ M Piletta sFlow, tipo M	Artikel-Nr. N. di articolo	Beckentiefe Profondità	Exkl. MWST IVA esclusa	Inkl. MWST IVA inclusa	VRG TAR	
Linero LIO CD 50F/17	Cristadur, Puro	3 1/2" TouchFlow Desino	10.105.288.00 	165 mm	B	1626.–	1758.–	0.19
		3 1/2" Raumspar Desino Salvaspazio Desino	10.105.289.00 	165 mm	B	1416.–	1531.–	
	Cristadur, Stone	3 1/2" TouchFlow Desino	10.105.292.00 	165 mm	B	1626.–	1758.–	0.19
		3 1/2" Raumspar Desino Salvaspazio Desino	10.105.293.00 	165 mm	B	1416.–	1531.–	
	Cristadur, Polaris	3 1/2" TouchFlow Desino	10.105.290.00 	165 mm	B	1626.–	1758.–	0.19
		3 1/2" Raumspar Desino Salvaspazio Desino	10.105.291.00 	165 mm	B	1416.–	1531.–	



Linero: LIO CD 50F/17

Linero: LIO CDAB 50F/17 Black Edition

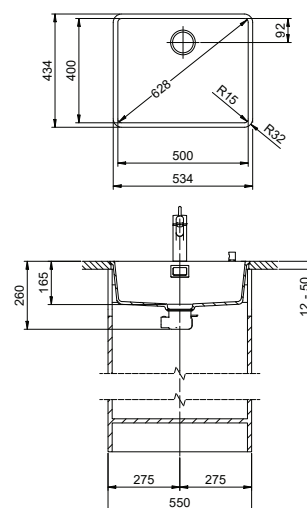
Randbreite 17 mm
Larghezza bordo 17 mmSCHOCK
CRISTADUR®

 Schwenkbare Überlaufkappe
Placchetta di troppopieno a ribalta

27

 Desino: Verdeckter Ablauf mit untenliegendem Sieb
Desino: Scarico coperto con griglietta inferiore

26

Für TouchFlow Desino und Raumspar Desino
Per TouchFlow Desino e Salvaspazio DesinoFür TouchFlow Desino und Raumspar Desino
Per TouchFlow Desino e Salvaspazio DesinoZeichnung als pdf / dxf und Montageanleitung siehe:
V. disegno in formato pdf / dxf e montaggio:
suter.ch

Optionales Zubehör / Accessori opzionali

310

Resteschale gelocht Vaschetta forato	Resteschale ungelocht Vaschetta non forato	Schneidebrett aus Glas Tagliere in vetro	Schneidebrett aus Kunststoff Tagliere sintetico
CHF 106.– 40.000.912.00	CHF 106.– 40.001.289.00	CHF 151.– 40.000.909.00	CHF 151.– 40.001.277.00
Inox Pad	Reinigungsset Easy Care Kit di pulizia Easy Care		
CHF 125.– 40.001.138.00	CHF 43.–/F 40.001.509.00		

**Nur für flächenbündigen Einbau erhältlich.**
Disponibile solo per montaggio a filo top.**Flächenbündiger Einbau: Empfehlung zur Wahl der Arbeitsplatte**

Wir empfehlen den Einbau in Arbeitsplatten aus Keramik, Granit, Kunststein (z.B. Corian oder Varicor) oder Massivholz. Vom Einbau in beschichtete Spanplatten raten wir ab.

Montaggio a filo top: Consiglio per la scelta del piano di lavoro

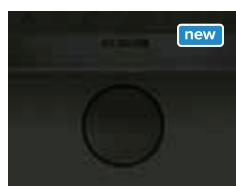

Consigliamo il montaggio nei piani di lavoro in ceramica, granito, pietra artificiale (per es. Corian o Varicor) oppure in legno massiccio. Sconsigliamo la posa in pannelli di truciolato rivestiti.

**DEC-Beschichtung, schwarz matt**
Rivestimento a DEC, nero opaco
3 1/2" TouchFlow Desino**DEC-Beschichtung, schwarz matt**
Rivestimento a DEC, nero opaco
3 1/2" Raumspar Desino / Salvaspazio Desino**Beschichtete Ventilbestandteile: im Preis inbegriffen**TouchFlow Desino und Raumspar Desino: Abflusssieb Desino, Überlaufblende und Überlaufkappe
Raumspar Desino: Bei der Black Edition ist der Zugknopf Advant (pulverbeschichtet, schwarz, matt) im Preis und Lieferumfang enthalten**Componenti piletta rivestiti: incluso nel prezzo**

TouchFlow Desino e Salvaspazio Desino: griglietta per lo scarico Desino, mascherina e tappo di troppopieno

Salvaspazio Desino: La Black Edition comprende il pomolo Advant (rivestimento con polvere, nero, opaco) nel prezzo e nel corredo di fornitura

Preis CHF/Prezzo in CHF

Modell Modello	Material Materiale	Ventil sFlow, Typ M Piletta sFlow, tipo M	Artikel-Nr. N. di articolo	Beckentiefe Profondità	Exkl. MWST IVA esclusa	Inkl. MWST IVA inclusa	VRG TAR	
Linero LIO CDAB 50F/17 Black Edition	Cristadur, Puro	3 1/2" TouchFlow Desino	10.105.288.50 	165 mm	B	1806.–	1952.–	0.19
		3 1/2" Raumspar Desino Salvaspazio Desino	10.105.289.50 	165 mm	B	1596.–	1725.–	

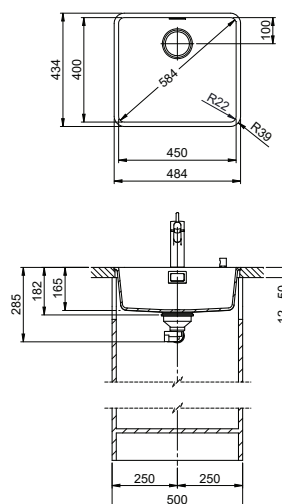
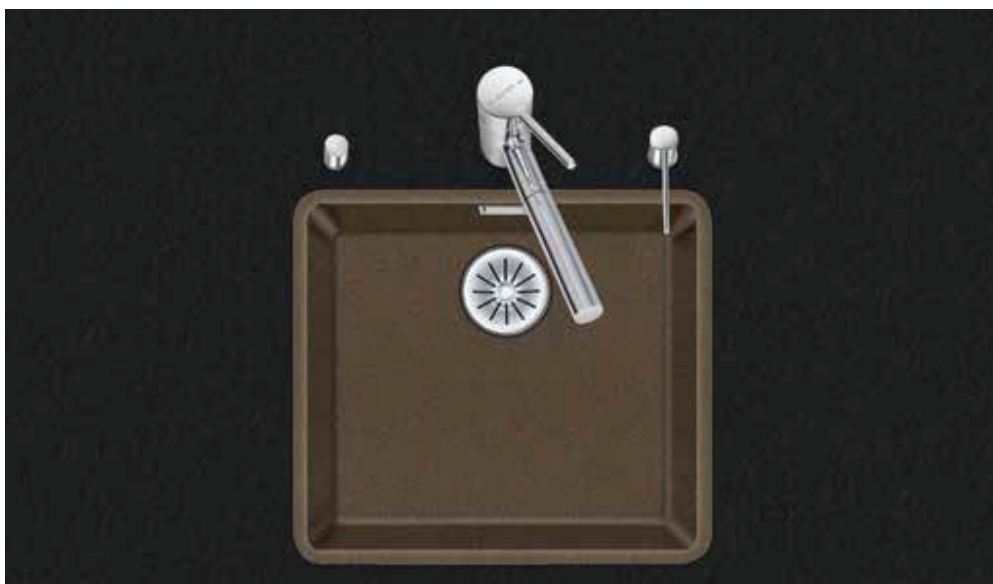

Daneo: DAN CP 45F/17

Randbreite 17 mm
Larghezza bordo 17 mmSCHOCK
CRISTALITE®

 Schwenkbare Überlaufkappe
Placchetta di troppopieno a ribalta

27

 Obenliegendes Sieb
Griglietta superiore

26



Zeichnung als pdf / dxf und Montageanleitung siehe:
V. disegno in formato pdf / dxf e montaggio:
suter.ch

Optionales Zubehör / Accessori opzionali

310

Resteschale gelocht
Vaschetta forata

CHF 106.- 40.000.912.00

Resteschale ungelocht
Vaschetta non forata

CHF 106.- 40.001.289.00

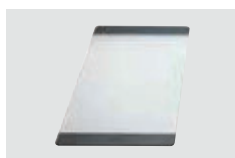
Schneidebrett aus Glas
Tagliere in vetro

CHF 151.- 40.000.909.00

Schneidebrett aus Kunststoff
Tagliere sintetico

CHF 151.- 40.001.277.00

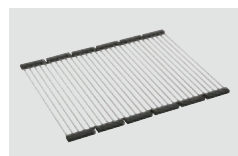
**Inox Pad**

CHF 125.- 40.001.138.00

Reinigungsset Easy Care
Kit di pulizia Easy Care

CHF 43.-/F 40.001.509.00

i Nur für flächenbündigen Einbau erhältlich.
Disponibile solo per montaggio a filo top.

Flächenbündiger Einbau: Empfehlung zur Wahl der Arbeitsplatte

Wir empfehlen den Einbau in Arbeitsplatten aus Keramik, Granit, Kunststein (z.B. Corian oder Varicor) oder Massivholz. Vom Einbau in beschichtete Spanplatten raten wir ab.

Montaggio a filo top: Consiglio per la scelta del piano di lavoro

Consigliamo il montaggio nei piani di lavoro in ceramica, granito, pietra artificiale (per es. Corian o Varicor) oppure in legno massiccio. Sconsigliamo la posa in pannelli di truciolato rivestiti.

i Mehrpreis für beschichtete Ventilbestandteile

TouchFlow und Raumspar: Stößel, Ventilkelch, Siebeinsatz, Überlaufblende und Überlaufkappe
Typo: Tipo-Siebstopfen, Ventilkelch, Überlaufblende und Überlaufkappe

Sovrapprezzo per componenti piletta rivestiti

TouchFlow e Salvaspazio: saltarello, tazza, griglietta, mascherina e tappo di troppopieno.
Typo: griglietta Tipo, tazza, mascherina e tappo di troppopieno.

PVD-Beschichtung, Graphit
Rivestimento a PVD, grafite
3 1/2" TouchFlow

CHF 169.-/F 40.002.562.02

PVD-Beschichtung, Graphit
Rivestimento a PVD, grafite
3 1/2" Raumspar / Salvaspazio

CHF 169.-/F 40.002.563.02

PVD-Beschichtung, Graphit
Rivestimento a PVD, grafite
3 1/2" Tipo

CHF 169.-/F 40.002.564.02

DEC-Beschichtung, schwarz matt
Rivestimento a DEC, nero opaco
3 1/2" TouchFlow

CHF 197.-/F 40.002.559.02

DEC-Beschichtung, schwarz matt
Rivestimento a DEC, nero opaco
3 1/2" Raumspar / Salvaspazio

CHF 197.-/F 40.002.560.02

DEC-Beschichtung, schwarz matt
Rivestimento a DEC, nero opaco
3 1/2" Tipo

CHF 197.-/F 40.002.561.02



Varianten: Für die flächenbündige Spüle Daneo mit Standard Zugknopf Advant Chrom bestellen Sie

xx.xxx.xx.01 Standardartikel ohne Zugknopf. Reduktion CHF 24.–. Im Austausch wählen Sie den gewünschten Zugknopf auf Seite 358.

xx.xxx.xx.02 Standardartikel ohne Ventilbestandteile und Überlaufkappe in Edelstahl. Im Austausch wählen Sie die Bestandteile in der Beckenfarbe auf Seite 282.

xx.xxx.xx.03 Standardartikel ohne Zugknopf, Ventilbestandteile und Überlaufkappe in Edelstahl. Reduktion CHF 24.–. Im Austausch wählen Sie den gewünschten Zugknopf und die Bestandteile in der Beckenfarbe auf Seite 358.





Varianti: per il lavello a filo top Daneo con pomolo standard Advant cromato, ordinate

xx.xxx.xx.01 – Articolo standard senza pomolo. Riduzione di CHF 24.–. In sostituzione, scegliete il pomolo desiderato a pagina 358.

xx.xxx.xx.02 – Articolo standard senza componenti piletta e tappo per troppopieno in acciaio inox. In sostituzione, scegliete i componenti nel colore del lavello a pagina 282.

xx.xxx.xx.03 – Articolo standard senza pomolo, componenti piletta e tappo per troppopieno in acciaio inox. Riduzione di CHF 24.–. In sostituzione, scegliete il pomolo desiderato e i componenti nel colore del lavello a pagina 358.

Preis CHF/Prezzo in CHF

Modell Modello	Material Materiale	Ventil Piletta	Artikel-Nr. N. di articolo	Beckentiefe Profondità	Exkl. MWST IVA esclusa	Inkl. MWST IVA inclusa	VRG TRA	
Daneo DAN CP 45F/17	Cristalite Plus, Nero 	3 1/2" TouchFlow	10.104.680.00 	165 mm	B	1324.–	1431.–	0.19
		3 1/2" Raumsparsalvaspazio	10.104.681.00 	165 mm	B	1126.–	1217.–	
		3 1/2" Tipo	10.104.682.00 	165 mm	B	1085.–	1173.–	
	Cristalite Plus, Asphalt 	3 1/2" TouchFlow	10.104.695.00 	165 mm	B	1324.–	1431.–	0.19
		3 1/2" Raumsparsalvaspazio	10.104.696.00 	165 mm	B	1126.–	1217.–	
		3 1/2" Tipo	10.104.697.00 	165 mm	B	1085.–	1173.–	
	Cristalite Plus, Mocha 	3 1/2" TouchFlow	10.104.689.00 	165 mm	B	1324.–	1431.–	0.19
		3 1/2" Raumsparsalvaspazio	10.104.690.00 	165 mm	B	1126.–	1217.–	
		3 1/2" Tipo	10.104.691.00 	165 mm	B	1085.–	1173.–	
	Cristalite Plus, Cromo 	3 1/2" TouchFlow	10.104.686.00 	165 mm	B	1324.–	1431.–	0.19
		3 1/2" Raumsparsalvaspazio	10.104.687.00 	165 mm	B	1126.–	1217.–	
		3 1/2" Tipo	10.104.688.00 	165 mm	B	1085.–	1173.–	
	Cristalite Plus, Everest 	3 1/2" TouchFlow	10.104.692.00 	165 mm	B	1324.–	1431.–	0.19
		3 1/2" Raumsparsalvaspazio	10.104.693.00 	165 mm	B	1126.–	1217.–	
		3 1/2" Tipo	10.104.694.00 	165 mm	B	1085.–	1173.–	
	Cristalite Plus, Superwhite/Alpina* 	3 1/2" TouchFlow	10.104.683.00 	165 mm	B	1324.–	1431.–	0.19
		3 1/2" Raumsparsalvaspazio	10.104.684.00 	165 mm	B	1126.–	1217.–	
		3 1/2" Tipo	10.104.685.00 	165 mm	B	1085.–	1173.–	

* Änderung der Farbbezeichnung: 2024 ändert sich die Farbbezeichnung von Superwhite in Alpina. Der Farbton an sich bleibt unverändert.

* Modifica della denominazione del colore: nel 2024, la denominazione del colore cambia da Superwhite ad Alpina. La tonalità del colore rimane invariata.

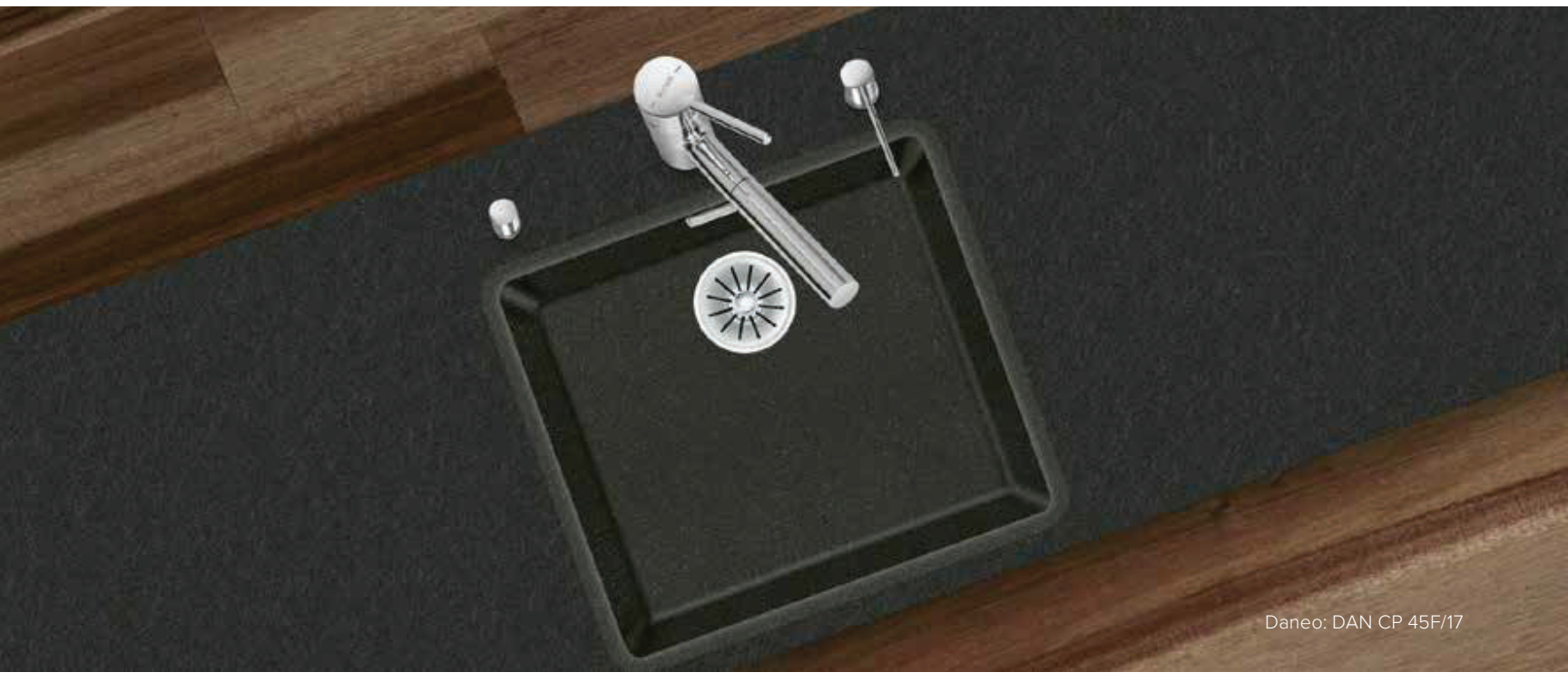

Daneo: DAN CP 50F/17

Randbreite 17 mm
Larghezza bordo 17 mm

SCHOCK
CRISTALITE®

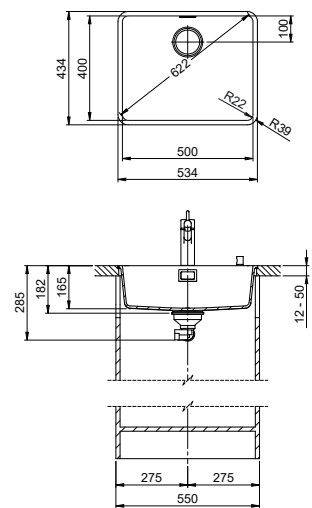
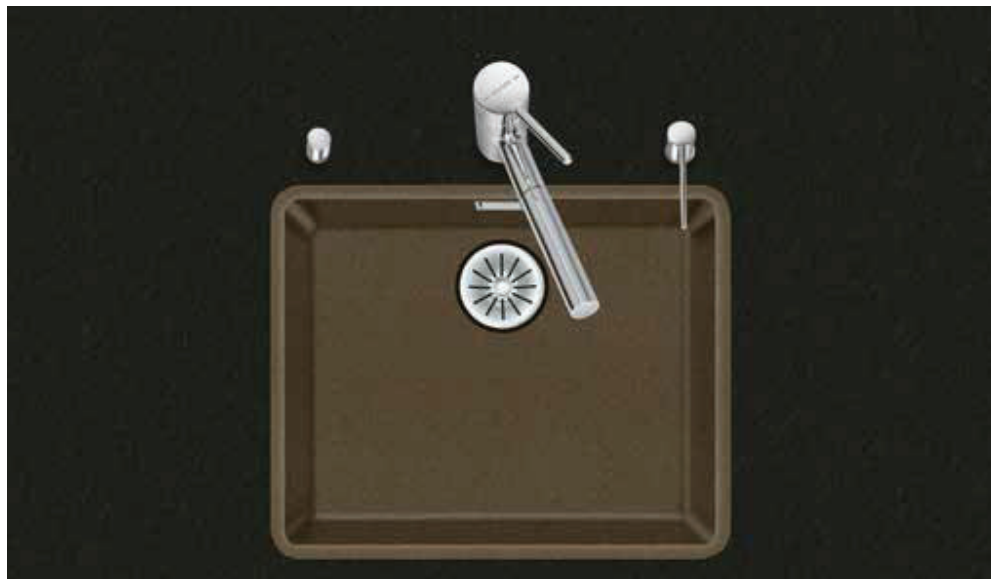

Schwenkbare Überlaufkappe
Placchetta di troppopieno a ribalta

Obenliegendes Sieb
Griglietta superiore

26



Zeichnung als pdf / dxf und Montageanleitung siehe:
V. disegno in formato pdf / dxf e montaggio:
suter.ch

Optionales Zubehör / Accessori opzionali

310

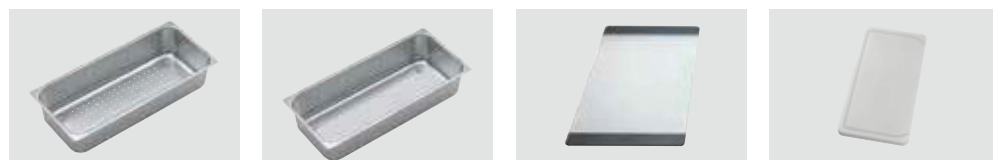

Resteschale gelocht
Vaschetta forato
CHF 106.- 40.000.912.00

Resteschale ungelocht
Vaschetta non forato
CHF 106.- 40.001.289.00

Schneidebrett aus Glas
Tagliere in vetro
CHF 151.- 40.000.909.00

Schneidebrett aus Kunststoff
Tagliere sintetico
CHF 151.- 40.001.277.00

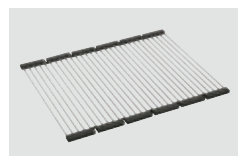

Inox Pad
CHF 125.- 40.001.138.00



Reinigungsset Easy Care
Kit di pulizia Easy Care
CHF 43.-/F 40.001.509.00

Nur für flächenbündigen Einbau erhältlich.
Disponibile solo per montaggio a filo top.

Flächenbündiger Einbau: Empfehlung zur Wahl der Arbeitsplatte

Wir empfehlen den Einbau in Arbeitsplatten aus Keramik, Granit, Kunststein (z.B. Corian oder Varicor) oder Massivholz. Vom Einbau in beschichtete Spanplatten raten wir ab.

Montaggio a filo top: Consiglio per la scelta del piano di lavoro

Consigliamo il montaggio nei piani di lavoro in ceramica, granito, pietra artificiale (per es. Corian o Varicor) oppure in legno massiccio. Sconsigliamo la posa in pannelli di truciolato rivestiti.

Mehrpreis für beschichtete Ventilbestandteile

TouchFlow und Raumspar: Stössel, Ventilkelch, Siebeinsatz, Überlaufblende und Überlaufkappe
Typo: Tipo-Siebstopfen, Ventilkelch, Überlaufblende und Überlaufkappe

Sovrapprezzo per componenti piletta rivestiti

TouchFlow e Salvaspazio: saltarello, tazza, griglietta, mascherina e tappo di troppopieno.
Typo: griglietta Tipo, tazza, mascherina e tappo di troppopieno.

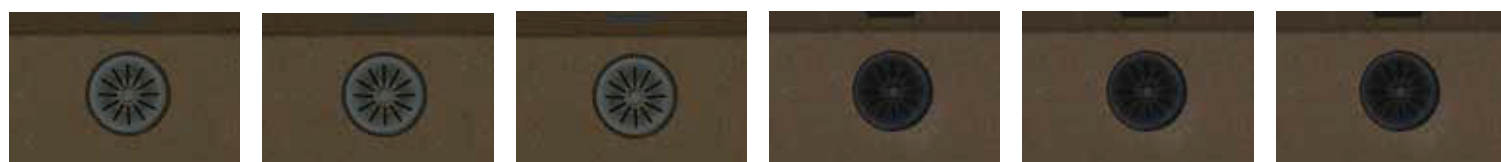

PVD-Beschichtung, Graphit
Rivestimento a PVD, grafite
3 1/2" TouchFlow

PVD-Beschichtung, Graphit
Rivestimento a PVD, grafite
3 1/2" Raumspar / Salvaspazio

PVD-Beschichtung, Graphit
Rivestimento a PVD, grafite
3 1/2" Typo

DEC-Beschichtung, schwarz matt
Rivestimento a DEC, nero opaco
3 1/2" TouchFlow

DEC-Beschichtung, schwarz matt
Rivestimento a DEC, nero opaco
3 1/2" Raumspar / Salvaspazio

DEC-Beschichtung, schwarz matt
Rivestimento a DEC, nero opaco
3 1/2" Typo

CHF 169.-/F 40.002.562.02

CHF 169.-/F 40.002.563.02

CHF 169.-/F 40.002.564.02

CHF 197.-/F 40.002.559.02

CHF 197.-/F 40.002.560.02

CHF 197.-/F 40.002.561.02



Varianten: Für die flächenbündige Spüle Daneo mit Standard Zugknopf Advant Chrom bestellen Sie

xx.xxx.xx.01 Standardartikel ohne Zugknopf. Reduktion CHF 24.–. Im Austausch wählen Sie den gewünschten Zugknopf auf Seite 358.

xx.xxx.xx.02 Standardartikel ohne Ventilbestandteile und Überlaufkappe in Edelstahl. Im Austausch wählen Sie die Bestandteile in der Beckenfarbe auf Seite 284.

xx.xxx.xx.03 Standardartikel ohne Zugknopf, Ventilbestandteile und Überlaufkappe in Edelstahl. Reduktion CHF 24.–. Im Austausch wählen Sie den gewünschten Zugknopf und die Bestandteile in der Beckenfarbe auf Seite 358.















Varianti: per il lavello a filo top Daneo con pomolo standard Advant cromato, ordinate

xx.xxx.xx.01 – Articolo standard senza pomolo. Riduzione di CHF 24.–. In sostituzione, scegliete il pomolo desiderato a pagina 358.

xx.xxx.xx.02 – Articolo standard senza componenti piletta e tappo per troppopieno in acciaio inox. In sostituzione, scegliete i componenti nel colore del lavello a pagina 284.

xx.xxx.xx.03 – Articolo standard senza pomolo, componenti piletta e tappo per troppopieno in acciaio inox. Riduzione di CHF 24.–. In sostituzione, scegliete il pomolo desiderato e i componenti nel colore del lavello a pagina 358.

Preis CHF/Prezzo in CHF

Modell Modello	Material Materiale	Ventil Piletta	Artikel-Nr. N. di articolo	Beckentiefe Profondità	Exkl. MWST IVA esclusa	Inkl. MWST IVA inclusa	VRG TRA	
Daneo DAN CP 50F/17	Cristalite Plus, Nero 	3 1/2" TouchFlow	10.104.698.00 	165 mm	B	1332.–	1440.–	0.19
		3 1/2" Raumspar Salvaspazio	10.104.699.00 	165 mm	B	1134.–	1226.–	
		3 1/2" Tipo	10.104.700.00 	165 mm	B	1093.–	1182.–	
	Cristalite Plus, Asphalt 	3 1/2" TouchFlow	10.104.713.00 	165 mm	B	1332.–	1440.–	0.19
		3 1/2" Raumspar Salvaspazio	10.104.714.00 	165 mm	B	1134.–	1226.–	
		3 1/2" Tipo	10.104.715.00 	165 mm	B	1093.–	1182.–	
	Cristalite Plus, Mocha 	3 1/2" TouchFlow	10.104.707.00 	165 mm	B	1332.–	1440.–	0.19
		3 1/2" Raumspar Salvaspazio	10.104.708.00 	165 mm	B	1134.–	1226.–	
		3 1/2" Tipo	10.104.709.00 	165 mm	B	1093.–	1182.–	
	Cristalite Plus, Cromo 	3 1/2" TouchFlow	10.104.704.00 	165 mm	B	1332.–	1440.–	0.19
		3 1/2" Raumspar Salvaspazio	10.104.705.00 	165 mm	B	1134.–	1226.–	
		3 1/2" Tipo	10.104.706.00 	165 mm	B	1093.–	1182.–	
	Cristalite Plus, Everest 	3 1/2" TouchFlow	10.104.710.00 	165 mm	B	1332.–	1440.–	0.19
		3 1/2" Raumspar Salvaspazio	10.104.711.00 	165 mm	B	1134.–	1226.–	
		3 1/2" Tipo	10.104.712.00 	165 mm	B	1093.–	1182.–	
	Cristalite Plus, Superwhite/Alpina* 	3 1/2" TouchFlow	10.104.701.00 	165 mm	B	1332.–	1440.–	0.19
		3 1/2" Raumspar Salvaspazio	10.104.702.00 	165 mm	B	1134.–	1226.–	
		3 1/2" Tipo	10.104.703.00 	165 mm	B	1093.–	1182.–	

* Änderung der Farbbezeichnung: 2024 ändert sich die Farbbezeichnung von Superwhite in Alpina. Der Farbton an sich bleibt unverändert.

* Modifica della denominazione del colore: nel 2024, la denominazione del colore cambia da Superwhite ad Alpina. La tonalità del colore rimane invariata.

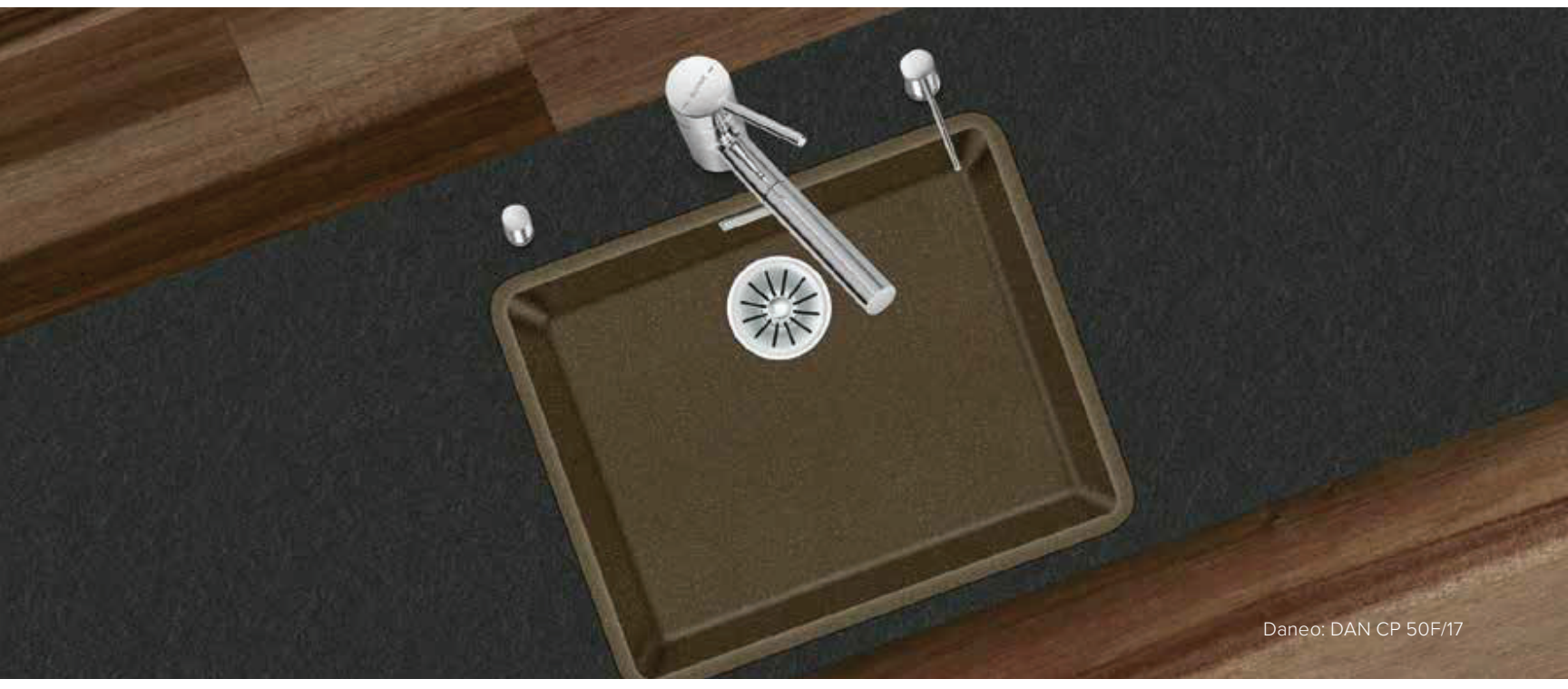

Daneo: DAN CP 55F/17

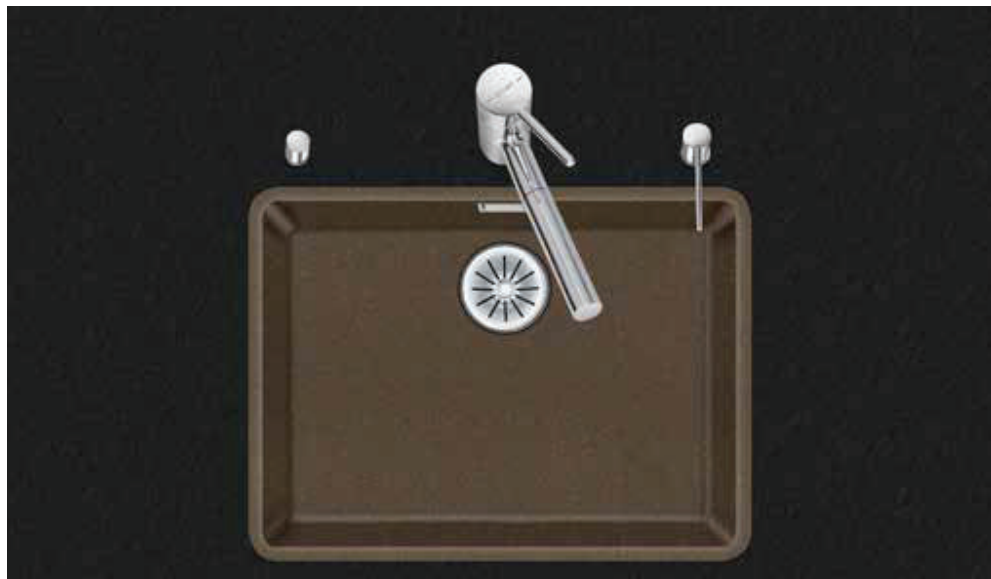
Randbreite 17 mm
Larghezza bordo 17 mmSCHOCK
CRISTALITE®

 Schwenkbare Überlaufkappe
Placchetta di troppopieno a ribalta

27

 Obenliegendes Sieb
Griglietta superiore

26

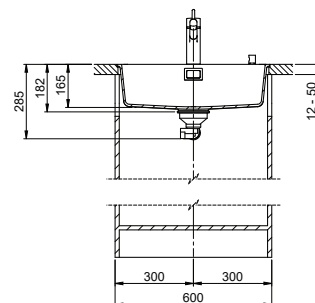
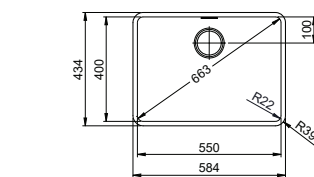

Zeichnung als pdf / dxf und Montageanleitung siehe:
V. disegno in formato pdf / dxf e montaggio:
suter.ch

Optionales Zubehör / Accessori opzionali

310

 Nur für flächenbündigen Einbau erhältlich.
Disponibile solo per montaggio a filo top.

Resteschale gelocht
Vaschetta forato
CHF 106.- 40.000.912.00

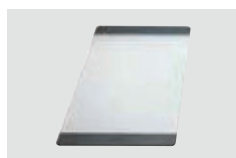
Resteschale ungelocht
Vaschetta non forato
CHF 106.- 40.001.289.00

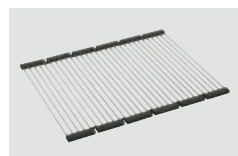
Schneidebrett aus Glas
Tagliere in vetro
CHF 151.- 40.000.909.00

Schneidebrett aus Kunststoff
Tagliere sintetico
CHF 151.- 40.001.277.00

Inox Pad
CHF 125.- 40.001.138.00

Reinigungsset Easy Care
Kit di pulizia Easy Care
CHF 43.-/F 40.001.509.00

Flächenbündiger Einbau: Empfehlung zur Wahl der Arbeitsplatte

Wir empfehlen den Einbau in Arbeitsplatten aus Keramik, Granit, Kunststein (z.B. Corian oder Varicor) oder Massivholz. Vom Einbau in beschichtete Spanplatten raten wir ab.

Montaggio a filo top: Consiglio per la scelta del piano di lavoro

Consigliamo il montaggio nei piani di lavoro in ceramica, granito, pietra artificiale (per es. Corian o Varicor) oppure in legno massiccio. Sconsigliamo la posa in pannelli di truciolato rivestiti.

Mehrpreis für beschichtete Ventilbestandteile

TouchFlow und Raumspar: Stössel, Ventilkelch, Siebeinsatz, Überlaufblende und Überlaufkappe
Typo: Tipo-Siebstopfen, Ventilkelch, Überlaufblende und Überlaufkappe

Sovrapprezzo per componenti piletta rivestiti

TouchFlow e Salvaspazio: saltarello, tazza, griglietta, mascherina e tappo di troppopieno.
Tipo: griglietta Tipo, tazza, mascherina e tappo di troppopieno.

PVD-Beschichtung, Graphit
Rivestimento a PVD, grafite
3 1/2" TouchFlow
CHF 169.-/F 40.002.562.02

PVD-Beschichtung, Graphit
Rivestimento a PVD, grafite
3 1/2" Raumspar / Salvaspazio
CHF 169.-/F 40.002.563.02

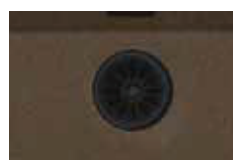
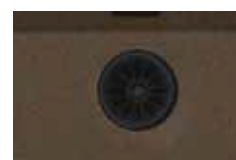
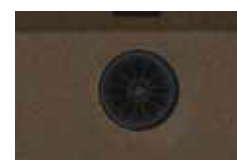







PVD-Beschichtung, Graphit
Rivestimento a PVD, grafite
3 1/2" Tipo
CHF 169.-/F 40.002.564.02

DEC-Beschichtung, schwarz matt
Rivestimento a DEC, nero opaco
3 1/2" TouchFlow
CHF 197.-/F 40.002.559.02

DEC-Beschichtung, schwarz matt
Rivestimento a DEC, nero opaco
3 1/2" Raumspar / Salvaspazio
CHF 197.-/F 40.002.560.02

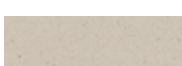
DEC-Beschichtung, schwarz matt
Rivestimento a DEC, nero opaco
3 1/2" Tipo
CHF 197.-/F 40.002.561.02

! Varianten: Für die flächenbündige Spüle Daneo mit Standard Zugknopf Advant Chrom bestellen Sie
 xx.xxx.xx.01 Standardartikel ohne Zugknopf. Reduktion CHF 24.–. Im Austausch wählen Sie den gewünschten Zugknopf auf Seite 358.
 xx.xxx.xx.02 Standardartikel ohne Ventilbestandteile und Überlaufkappe in Edelstahl. Im Austausch wählen Sie die Bestandteile in der Beckenfarbe auf Seite 286.
 xx.xxx.xx.03 Standardartikel ohne Zugknopf, Ventilbestandteile und Überlaufkappe in Edelstahl. Reduktion CHF 24.–. Im Austausch wählen Sie den gewünschten Zugknopf und die Bestandteile in der Beckenfarbe auf Seite 358.

Varianti: per il lavello a filo top Daneo con pomolo standard Advant cromato, ordinate

xx.xxx.xx.01 – Articolo standard senza pomolo. Riduzione di CHF 24.–. In sostituzione, scegliete il pomolo desiderato a pagina 358.
 xx.xxx.xx.02 – Articolo standard senza componenti piletta e tappo per troppopieno in acciaio inox. In sostituzione, scegliete i componenti nel colore del lavello a pagina 286.
 xx.xxx.xx.03 – Articolo standard senza pomolo, componenti piletta e tappo per troppopieno in acciaio inox. Riduzione di CHF 24.–. In sostituzione, scegliete il pomolo desiderato e i componenti nel colore del lavello a pagina 358.

Preis CHF/Prezzo in CHF

Modell Modello	Material Materiale	Ventil Piletta	Artikel-Nr. N. di articolo	Beckentiefe Profondità	Exkl. MWST IVA esclusa	Inkl. MWST IVA inclusa	VRG TRA	
Daneo DAN CP 55F/17	Cristalite Plus, Nero 	3 1/2" TouchFlow	10.104.716.00 	165 mm	B	1563.–	1690.–	0.19
		3 1/2" Raumspar Extra plate	10.104.717.00 	165 mm	B	1365.–	1476.–	
		3 1/2" Tipo	10.104.718.00 	165 mm	B	1324.–	1431.–	
	Cristalite Plus, Asphalt 	3 1/2" TouchFlow	10.104.731.00 	165 mm	B	1563.–	1690.–	0.19
		3 1/2" Raumspar Extra plate	10.104.732.00 	165 mm	B	1365.–	1476.–	
		3 1/2" Tipo	10.104.733.00 	165 mm	B	1324.–	1431.–	
	Cristalite Plus, Mocha 	3 1/2" TouchFlow	10.104.725.00 	165 mm	B	1563.–	1690.–	0.19
		3 1/2" Raumspar Extra plate	10.104.726.00 	165 mm	B	1365.–	1476.–	
		3 1/2" Tipo	10.104.727.00 	165 mm	B	1324.–	1431.–	
	Cristalite Plus, Cromo 	3 1/2" TouchFlow	10.104.722.00 	165 mm	B	1563.–	1690.–	0.19
		3 1/2" Raumspar Extra plate	10.104.723.00 	165 mm	B	1365.–	1476.–	
		3 1/2" Tipo	10.104.724.00 	165 mm	B	1324.–	1431.–	
	Cristalite Plus, Everest 	3 1/2" TouchFlow	10.104.728.00 	165 mm	B	1563.–	1690.–	0.19
		3 1/2" Raumspar Extra plate	10.104.729.00 	165 mm	B	1365.–	1476.–	
		3 1/2" Tipo	10.104.730.00 	165 mm	B	1324.–	1431.–	
	Cristalite Plus, Superwhite/Alpina* 	3 1/2" TouchFlow	10.104.719.00 	165 mm	B	1563.–	1690.–	0.19
		3 1/2" Raumspar Extra plate	10.104.720.00 	165 mm	B	1365.–	1476.–	
		3 1/2" Tipo	10.104.721.00 	165 mm	B	1324.–	1431.–	

* Änderung der Farbbezeichnung: 2024 ändert sich die Farbbezeichnung von Superwhite in Alpina. Der Farbton an sich bleibt unverändert.
 * Modifica della denominazione del colore: nel 2024, la denominazione del colore cambia da Superwhite ad Alpina. La tonalità del colore rimane invariata.

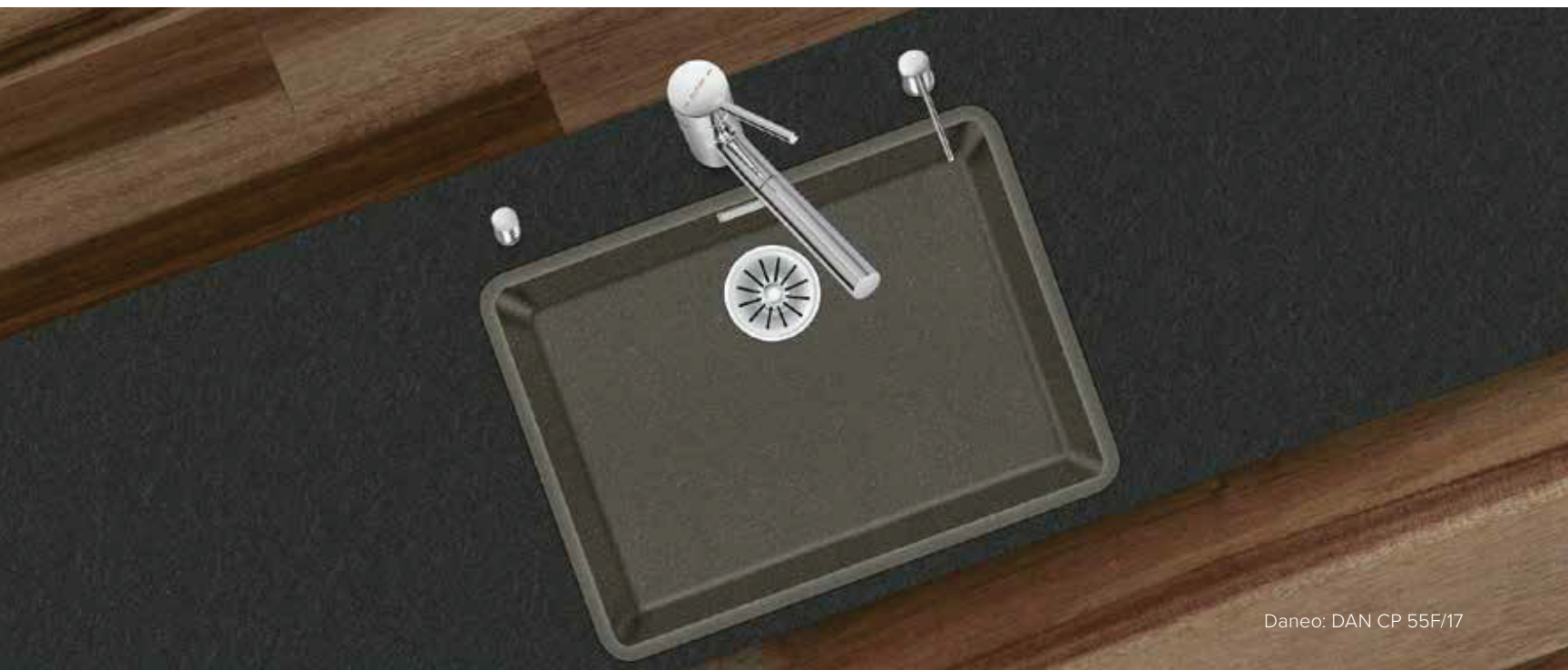

Daneo: DAN CP 55F/17

IF-Spülen
IF-Lavelli



Zaros: ZOS 90



Zaros: ZOS 100

Sortiment nach Unterschrankmassen**Assortimento per dimensioni di base** **290****Edelstahl / Acciaio inox****Silver Star**

SIL 50	292
SIL 100	293

Zaros

ZOS 75	294
ZOS 90	295
ZOS 100	296

Comfort

COM 34	297
COM 40	298
COM 75	299
COM 90	300
C 75	301
C 90	302

Spezialeinleger / Lavello da incasso speciale

MCOM 90	303
MCOM 34	304

Rund

R 44B	305
-------	------------

**Granit (Cristalite Plus)
Granito (Cristalite Plus)****Nemo**

NEM N 100	306
-----------	------------

Primus

PRI D 100	307
PRI D 100L	308

Montagematerial / Materiale per il montaggio

Holz-Klick* /
Attacco per legno*
40.000.351.00



Stein-Klick* /
Attacco per pietra*
40.000.435.00





















Befestigungsklammern für Einlege-
Spülen und Flächenbündige-Spülen/
Staffe di fissaggio per lavelli a filo top e
lavelli sopra piano
40.002.041.00

Im Lieferumfang enthalten / Materiale per il montaggio incluso nella fornitura

* Bitte bei Spülen mit diesem Symbol den gewünschten Typ angeben.

* Per i lavelli recanti questo simbolo si prega di indicare il modello richiesto.

Sortiment nach Unterschrankmassen / Assortimento per dimensioni di base

	40cm	45cm
Silver Star		
Zaros		 Zaros: ZOS 75 
Comfort	 Comfort: COM 34 	 Comfort: COM 40   Comfort: COM 75   Comfort: COM 90   Comfort: C 75   Comfort: C 90 
Primus/Nemo		 Primus: PRI D 100 
Einzel-Becken Lavelli a vasca singola		 Rund: R 44B 

50cm

55cm

60cm



Silver Star: SIL 50 



Silver Star: SIL 100 



Zaros: ZOS 90 



Zaros: ZOS 100 



Nemo: NEM N 100 



Primus: PRI D 100L 

Silver Star: SIL 50



Verdeckter Überlauf
Troppieno coperto



Obenliegendes Sieb
Griglietta superiore



26

Optionales Zubehör / Accessori opzionali

310



Resteschale gelocht
Vaschetta forato

CHF 106.– 40.000.916.00

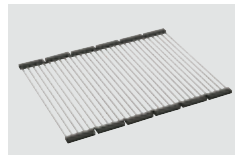

Inox Pad

CHF 125.– 40.001.139.00

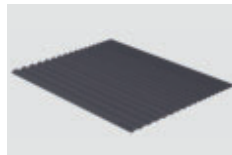

Maro Abtropfmatte aus Silikon
Maro tappetino scolapiatti in silicone

CHF 51.– 40.002.008.00

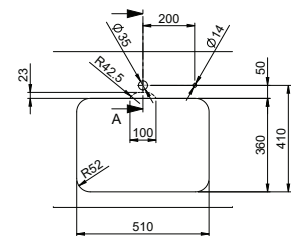
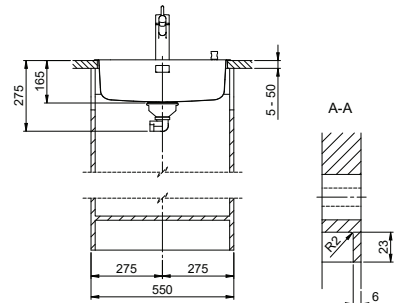
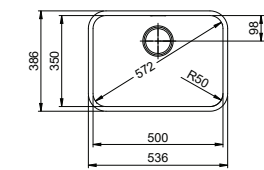

Zeichnung als pdf / dxf und Montageanleitung siehe:
V. disegno in formato pdf / dxf e montaggio:
suter.ch

Wählen Sie den Oberflächenfinish:
In den Ausführungen glanz und matt erhältlich.

Scegliete la finitura:
Disponibile nelle finiture lucido e opaco.

Varianten: Für die Einlege-Spüle Silver Star mit Standard Zugknopf Prime Chrom bestellen Sie
xx.xxx.xx.01 Standardartikel ohne Zugknopf. Reduktion CHF 24.–. Im Austausch wählen Sie den gewünschten Zugknopf auf Seite 358.
Varianti: per il lavello sottopiano Silver Star con pomolo standard Prime cromato, ordinate
xx.xxx.xx.01 – Articolo standard senza pomolo. Riduzione di CHF 24.–. In sostituzione, scegliete il pomolo desiderato a pagina 358.

Preis CHF/Prezzo in CHF

Modell Modello	Material Materiale	Ventil Piletta	Artikel-Nr. N. di articolo	Tropfteil Scolatoio	Exkl. MWST IVA esclusa	Inkl. MWST IVA inclusa
Silver Star SIL 50	Edelstahl, matt Acciaio inox, opaco	3 1/2" Raumspar Salvaspazio	10.103.956.00	165 mm	A 776.–	839.–
		3 1/2" Tipo	10.103.957.00	165 mm	A 727.–	786.–
	Edelstahl, glanz Acciaio inox, lucido	3 1/2" Raumspar Salvaspazio	10.103.953.00	165 mm	A 776.–	839.–
		3 1/2" Tipo	10.103.954.00	165 mm	A 727.–	786.–

Silver Star: SIL 100

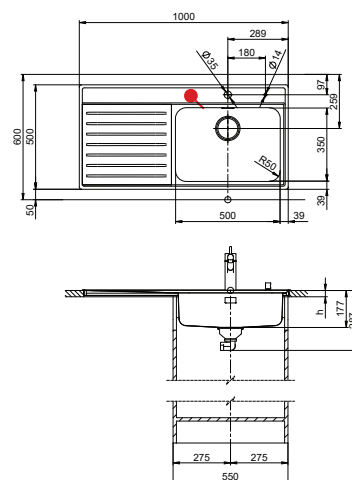

Verdeckter Überlauf
Troppieno coperto

Obenliegendes Sieb
Griglietta superiore

26



Aussenmasse
Dimensioni esterne:
1000 x 500 mm
Ausschnitt / Intaglio:
984 x 484 +2/-0 mm
R = ca. 5 mm
h = > 28 mm (Holz / Legno)
h = 28 – 32 mm (Stein / Pietra)

Optionales Zubehör / Accessori opzionali

310



Resteschale gelocht
Vaschetta forato
CHF 106.– 40.000.916.00

Schneidebrett aus Glas
Tagliere in vetro
CHF 151.– 40.000.909.00

Maro Abtropfmatte aus Silikon
Maro tappetino scolapiatti in silicone
CHF 51.– 40.002.008.00

Zeichnung als pdf / dxf und Montageanleitung siehe:
V. disegno in formato pdf / dxf e montaggio:
suter.ch

Varianten: Für die Einlege-Spüle Silver Star mit Standard Zugknopf Advant Chrom bestellen Sie
xx.xxx.xx.01 Standardartikel ohne Zugknopf. Reduktion CHF 24.–. Im Austausch wählen Sie den gewünschten Zugknopf auf Seite 358.
Varianti: per il lavello sottopiano Silver Star con pomolo standard Advant cromato, ordinate
xx.xxx.xx.01 – Articolo standard senza pomolo. Riduzione di CHF 24.–. In sostituzione, scegliete il pomolo desiderato a pagina 358.

Preis CHF / Prezzo in CHF

Modell Modello	Material Materiale	Ventil Piletta	Artikel-Nr. N. di articolo	Tropfteil Scolatoio	Exkl. MWST IVA esclusa	Inkl. MWST IVA inclusa
Silver Star SIL 100	Edelstahl, glanz Acciaio inox, lucido	18/10	3 1/2" Raumspar Salvaspazio	10.102.119.00	A	1364.–
				10.102.120.00		

Zaros: ZOS 75

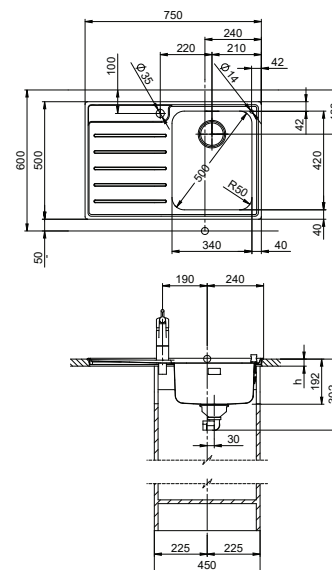

Verdeckter Überlauf
Troppieno coperto

Obenliegendes Sieb
Griglietta superiore

26



Aussenmasse
Dimensioni esterne:
750 x 500 mm
Ausschnitt / Intaglio:
734 x 484 +2/-0 mm
R = ca. 5 mm
h = >28 mm (Holz / Legno)
h = 28 – 32 mm (Stein / Pietra)

Optionales Zubehör / Accessori opzionali

310



Resteschale gelocht
Vaschetta forato

CHF 42.– 40.001.004.00

Resteschale gelocht
Vaschetta forato

CHF 106.– 40.000.971.00

Schneidebrett aus Glas
Tagliere in vetro

CHF 151.– 40.000.915.00

Maro Abtropfmatte aus Silikon
Maro tappetino scolapiatti in silicone

CHF 51.– 40.002.008.00

Zeichnung als pdf / dxf und Montageanleitung siehe:
V. disegno in formato pdf / dxf e montaggio:
suter.ch

Varianten: Für die Einlege-Spüle Zaros mit Standard Zugknopf Prime Chrom bestellen Sie
xx.xxx.xx.01 Standardartikel ohne Zugknopf. Reduktion CHF 24.–. Im Austausch wählen Sie den gewünschten Zugknopf auf Seite 358.
Varianti: per il lavello sottopiano Zaros con pomolo standard Prime cromato, ordinate
xx.xxx.xx.01 – Articolo standard senza pomolo. Riduzione di CHF 24.–. In sostituzione, scegliete il pomolo desiderato a pagina 358.

Preis CHF / Prezzo in CHF

Modell Modello	Material Materiale	Ventil Piletta	Artikel-Nr. N. di articolo	Tropfteil Scolatoio	Exkl. MWST IVA esclusa	Inkl. MWST IVA inclusa
Zaros ZOS 75	Edelstahl, glanz Acciaio inox, lucido	3 1/2" Raumspar Salvaspazio	10.103.110.00	Links / Sinistra	A	902.–
			10.103.111.00	Rechts / Destra		
		3 1/2" Tipo	10.103.112.00	Links / Sinistra	A	747.–
			10.103.113.00	Rechts / Destra		
		1 1/2" Standrohr Con tubo	10.103.108.00	Links / Sinistra	A	701.–
			10.103.109.00	Rechts / Destra		

Zaros: ZOS 90

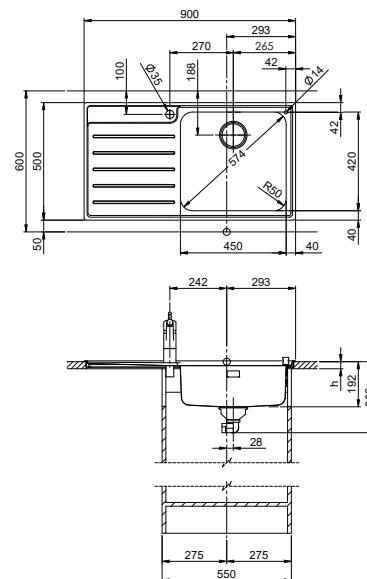

Verdeckter Überlauf
Trooppieno coperto

Obenliegendes Sieb
Griglietta superiore

26



Aussenmasse
Dimensioni esterne:
900 x 500 mm
Ausschnitt / Intaglio:
884 x 484 +2/-0 mm
R = ca. 5 mm
h = >28 mm (Holz / Legno)
h = 28 – 32 mm (Stein / Pietra)

Optionales Zubehör / Accessori opzionali

310

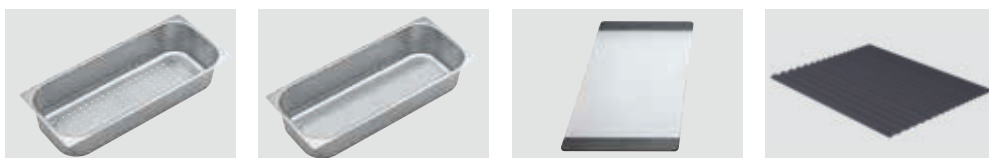

Resteschale gelocht
Vaschetta forato
CHF 106.– 40.000.914.00

Resteschale ungelocht
Vaschetta non forato
CHF 106.– 40.001.290.00

Schneidebrett aus Glas
Tagliere in vetro
CHF 151.– 40.000.915.00

Maro Abtropfmatte aus Silikon
Maro tappetino scolapiatti in silicone
CHF 51.– 40.002.008.00

Zeichnung als pdf / dxf und Montageanleitung siehe:
V. disegno in formato pdf / dxf e montaggio:
suter.ch

Varianten: Für die Einlege-Spüle Zaros mit Standard Zugknopf Prime Chrom bestellen Sie
xx.xxx.xx.01 Standardartikel ohne Zugknopf. Reduktion CHF 24.–. Im Austausch wählen Sie den gewünschten Zugknopf auf Seite 358.
Varianti: per il lavello sottopiano Zaros con pomolo standard Prime cromato, ordinate
xx.xxx.xx.01 – Articolo standard senza pomolo. Riduzione di CHF 24.–. In sostituzione, scegliete il pomolo desiderato a pagina 358.

Preis CHF / Prezzo in CHF

Modell Modello	Material Materiale	Ventil Piletta	Artikel-Nr. N. di articolo	Tropfteil Scolatoio	Exkl. MWST IVA esclusa	Inkl. MWST IVA inclusa
Zaros ZOS 90	Edelstahl, glanz Acciaio inox, lucido	18/10	3 1/2" Raumspar Salvaspazio	Links/Sinistra	A	1005.–
				Rechts/Destra		
			3 1/2" Tipo	Links/Sinistra	A	880.–
				Rechts/Destra		

Zaros: ZOS 100

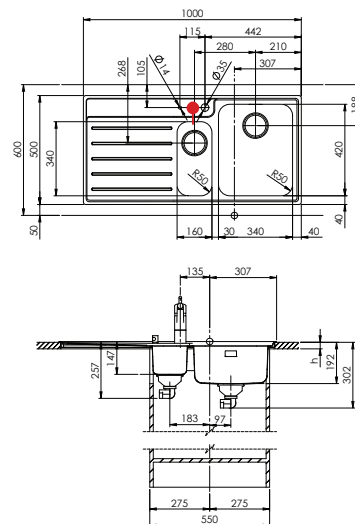

Verdeckter Überlauf
Troppieno coperto

Obenliegendes Sieb
Griglietta superiore

26



Aussenmasse
Dimensioni esterne:
1000 x 500 mm
Ausschnitt / Intaglio:
984 x 484 +2 / -0 mm
R = ca. 5 mm
h = >28 mm (Holz / Legno)
h = 28 – 32 mm (Stein / Pietra)

Inklusives Zubehör / Accessori inclusi



CHF42.– 40.001.004.00

Mehrpreis für Resteschale aus Edelstahl CHF 64.–
Sovrapprezzo per vaschetta in acciaio inox CHF 64.–

Zeichnung als pdf / dxf und Montageanleitung siehe:
V. disegno in formato pdf / dxf e montaggio:
suter.ch

Optionales Zubehör / Accessori opzionali

310



Resteschale gelocht
Vaschetta forato
CHF 106.– 40.000.971.00

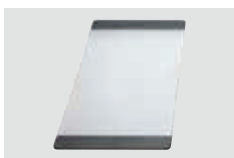

Schneidebrett aus Glas
Tagliere in vetro
CHF 151.– 40.000.915.00

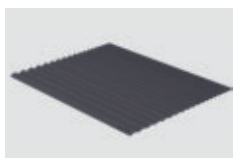

Maro Abtropfmatte aus Silikon
Maro tappetino scolapiatti in silicone
CHF 51.– 40.002.008.00

Varianten: Für die Einlege-Spüle Zaros mit Standard Zugknopf Prime Chrom bestellen Sie
xx.xxx.xx.01 Standardartikel ohne Zugknopf. Reduktion CHF 24.–. Im Austausch wählen Sie den gewünschten Zugknopf auf Seite 358.
Varianti: per il lavello sottopiano Zaros con pomolo standard Prime cromato, ordinate
xx.xxx.xx.01 – Articolo standard senza pomolo. Riduzione di CHF 24.–. In sostituzione, scegliete il pomolo desiderato a pagina 358.

Preis CHF / Prezzo in CHF

Modell Modello	Material Materiale	Ventil Piletta	Artikel-Nr. N. di articolo	Tropfteil Scolatoio	Exkl. MWST IVA esclusa	Inkl. MWST IVA inclusa
Zaros ZOS 100	Edelstahl, glanz Acciaio inox, lucido	18/10	3 1/2" Raumspar Salvaspazio	Links / Sinistra	A	1240.–
				Rechts / Destra		
			3 1/2" Tipo	Links / Sinistra	A	1104.–
				Rechts / Destra		

Comfort: COM 34



Verdeckter Überlauf
Trooppieno coperto

Obenliegendes Sieb
Griglietta superiore

26

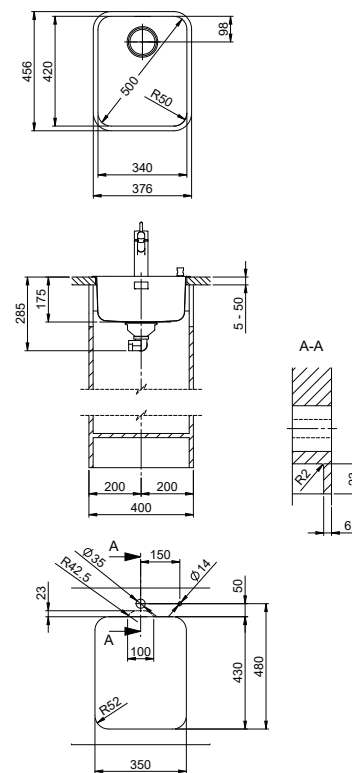

Optionales Zubehör / Accessori opzionali

310

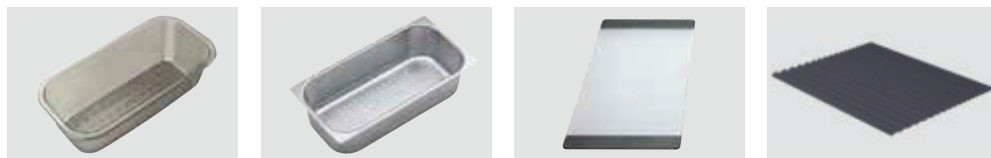

Resteschale gelocht
Vaschetta forato
CHF 42.– 40.001.004.00

Resteschale gelocht
Vaschetta forato
CHF 106.– 40.000.971.00

Schneidebrett aus Glas
Tagliere in vetro
CHF 151.– 40.000.915.00

Maro Abtropfmatte aus Silikon
Maro tappetino scolapiatti in silicone
CHF 51.– 40.002.008.00

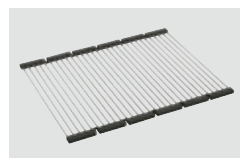

Innox Pad
CHF 125.– 40.000.138.00

Zeichnung als pdf / dxf und Montageanleitung siehe:
V. disegno in formato pdf / dxf e montaggio:
suter.ch

Varianten: Für die Einlege-Spüle Comfort mit Standard Zugknopf Prime Chrom bestellen Sie
xx.xxx.xx.01 Standardartikel ohne Zugknopf. Reduktion CHF 24.–. Im Austausch wählen Sie den gewünschten Zugknopf auf Seite 358.
Varianti: per il lavello sottopiano Comfort con pomolo standard Prime cromato, ordinate
xx.xxx.xx.01 – Articolo standard senza pomolo. Riduzione di CHF 24.–. In sostituzione, scegliete il pomolo desiderato a pagina 358.

Preis CHF/Prezzo in CHF

Modell Modello	Material Materiale	Ventil Piletta	Artikel-Nr. N. di articolo	Beckentiefe Profondità	Exkl. MWST IVA esclusa	Inkl. MWST IVA inclusa
Comfort COM 34	Edelstahl, glanz Acciaio inox, lucido	3 1/2" Raumspar Salvaspazio	10.102.726.00	175 mm	A	833.– 900.–
		3 1/2" Tipo	10.103.102.00	175 mm	A	792.– 856.–

Comfort: COM 40

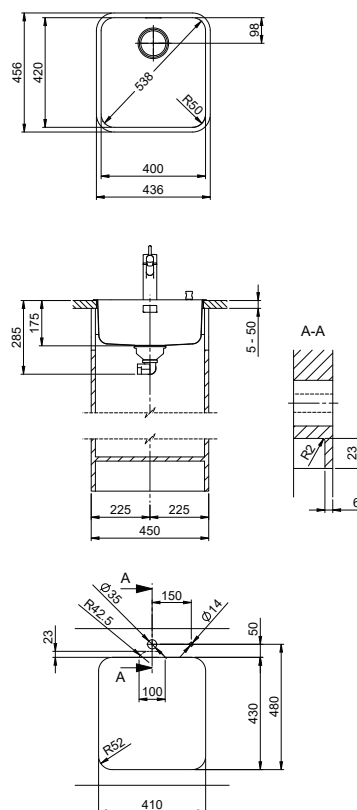

Verdeckter Überlauf
Troppopieno coperto

Obenliegendes Sieb
Griglietta superiore



Optionales Zubehör / Accessori opzionali

310

Resteschale gelocht Vaschetta forato	Resteschale ungelocht Vaschetta non forato	Schneidebrett aus Glas Tagliere in vetro	Holz-Schneidebrett aus Nussbaum Tagliere in legno di noce
CHF 106.– 40.000.914.00	CHF 106.– 40.001.290.00	CHF 151.– 40.000.915.00	CHF 151.– 40.001.147.00
Inox Pad	Maro Abtropfmatte aus Silikon Maro tappetino scolapiatti in silicone		
CHF 125.– 40.001.138.00	CHF 51.– 40.002.008.00		

Zeichnung als pdf / dxf und Montageanleitung siehe:
V. disegno in formato pdf / dxf e montaggio:
suter.ch

Varianten: Für die Einlege-Spüle Comfort mit Standard Zugknopf Prime Chrom bestellen Sie xx.xxx.xx.01 Standardartikel ohne Zugknopf. Reduktion CHF 24.–. Im Austausch wählen Sie den gewünschten Zugknopf auf Seite 358.
Varianti: per il lavello sottopiano Comfort con pomolo standard Prime cromato, ordinate xx.xxx.xx.01 – Articolo standard senza pomolo. Riduzione di CHF 24.–. In sostituzione, scegliete il pomolo desiderato a pagina 358.

Preis CHF/Prezzo in CHF

Modell Modello	Material Materiale	Ventil Piletta	Artikel-Nr. N. di articolo	Beckentiefe Profondità	Exkl. MWST IVA esclusa	Inkl. MWST IVA inclusa
Comfort COM 40	Edelstahl, glanz Acciaio inox, lucido	18 / 10 3 1/2" Raumspar Salvaspazio	10.103.204.00	175 mm	A 882.–	953.–
		3 1/2" Tipo	10.103.203.00	175 mm	A 841.–	909.–

Comfort: COM 75

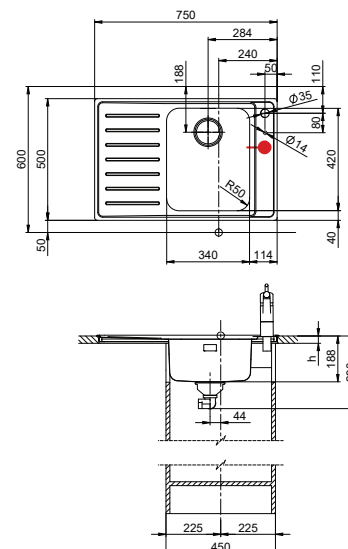

Verdeckter Überlauf
Trooppieno coperto

Obenliegendes Sieb
Griglietta superiore

26



Aussenmasse / Dimensioni esterne:
750 x 500 mm
Ausschnitt / Intaglio:
734 x 484 +2/-0 mm, R = ca. 5 mm
h = >28 mm (Holz / Legno),
h = 28 – 32 mm (Stein / Pietra)

Optionales Zubehör / Accessori opzionali

310

Zeichnung als pdf / dxf und Montageanleitung siehe:
V. disegno in formato pdf / dxf e montaggio:
suter.ch



Resteschale gelocht
Vaschetta forato
CHF 42.– 40.001.004.00

Resteschale gelocht
Vaschetta forato
CHF 106.– 40.000.971.00

Varianten: Für die Einlege-Spüle Comfort mit Standard Zugknopf Prime Chrom bestellen Sie
xx.xxx.xx.01 Standardartikel ohne Zugknopf. Reduktion CHF 24.–. Im Austausch wählen Sie den gewünschten Zugknopf auf Seite 358.
Varianti: per il lavello sottopiano Comfort con pomolo standard Prime cromato, ordinate
xx.xxx.xx.01 – Articolo standard senza pomolo. Riduzione di CHF 24.–. In sostituzione, scegliete il pomolo desiderato a pagina 358.

Preis CHF / Prezzo in CHF

Modell Modello	Material Materiale	Ventil Piletta	Artikel-Nr. N. di articolo	Tropfteil Scolatoio	Exkl. MWST IVA esclusa	Inkl. MWST IVA inclusa
Comfort COM 75	Edelstahl, glanz Acciaio inox, lucido	3 1/2" Raumspar Salvaspazio	10.102.729.00	Links / Sinistra	A	993.–
			10.102.730.00	Rechts / Destra		
		1 1/2" Standrohr Con tubo	10.102.727.00	Links / Sinistra	A	800.–
			10.102.728.00	Rechts / Destra		

Comfort: COM 90

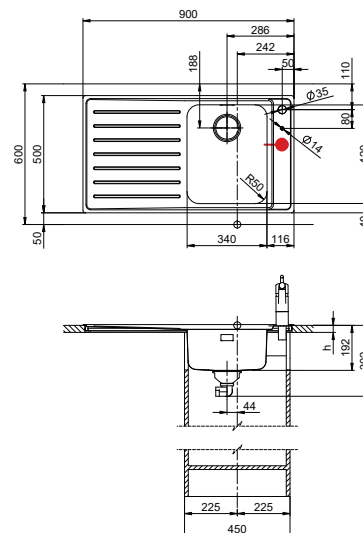

Verdeckter Überlauf
Trooppieno coperto

Obenliegendes Sieb
Griglietta superiore

26



Aussenmasse / Dimensioni esterne:
900 x 500 mm
Ausschnitt / Intaglio:
884 x 484 +2 / -0 mm, R = ca. 5 mm
h = >28 mm (Holz / Legno),
h = 28 - 32 mm (Stein / Pietra)

Optionales Zubehör / Accessori opzionali

310



Resteschale gelocht
Vaschetta forato

CHF 42.- 40.001.004.00

Resteschale gelocht
Vaschetta forato

CHF 106.- 40.000.971.00

Zeichnung als pdf / dxf und Montageanleitung siehe:
V. disegno in formato pdf / dxf e montaggio:
suter.ch

Varianten: Für die Einlege-Spüle Comfort mit Standard Zugknopf Prime Chrom bestellen Sie
xx.xxx.xx.01 Standardartikel ohne Zugknopf. Reduktion CHF 24.-. Im Austausch wählen Sie den gewünschten Zugknopf auf Seite 358.
Varianti: per il lavello sottopiano Comfort con pomolo standard Prime cromato, ordinate
xx.xxx.xx.01 - Articolo standard senza pomolo. Riduzione di CHF 24.-. In sostituzione, scegliete il pomolo desiderato a pagina 358.

Preis CHF / Prezzo in CHF

Modell Modello	Material Materiale	Ventil Piletta	Artikel-Nr. N. di articolo	Tropfteil Scolatoio	Exkl. MWST IVA esclusa	Inkl. MWST IVA inclusa
Comfort COM 90	Edelstahl, glanz Acciaio inox, lucido	3 1/2" Raumspar Salvaspazio	10.102.733.00	Links / Sinistra	A 1023.-	1106.-
			10.102.734.00	Rechts / Destra		
		1 1/2" Standrohr Con tubo	10.102.731.00	Links / Sinistra	A 848.-	917.-
			10.102.732.00	Rechts / Destra		

Comfort: C 75



- 1 1/2" Standrohr Con tubo ◀ 40 ▶
- 3 1/2" Raumspar Salvaspazio ▶ 45 ▶

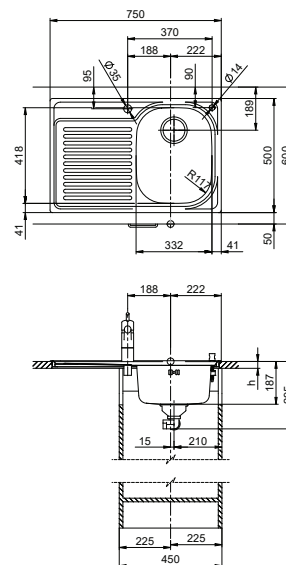

Aussenmasse / Dimensioni esterne:
 750 x 500 mm
 Ausschnitt / Intaglio:
 734 x 484 +2/-0 mm, R = ca. 5 mm
 h = >28 mm (Holz / Legno),
 h = 28 – 32 mm (Stein / Pietra)

Zeichnung als pdf / dxf und Montageanleitung siehe:
 V. disegno in formato pdf / dxf e montaggio:
suter.ch



Varianten: Für die Einlege-Spüle Comfort mit Standard Zugknopf Prime Chrom bestellen Sie
 xx.xxx.xx.01 Standardartikel ohne Zugknopf. Reduktion CHF 24.–. Im Austausch wählen Sie den gewünschten Zugknopf auf Seite 358.
Varianti: per il lavello sottopiano Comfort con pomolo standard Prime cromato, ordinate
 xx.xxx.xx.01 – Articolo standard senza pomolo. Riduzione di CHF 24.–. In sostituzione, scegliete il pomolo desiderato a pagina 358.

Preis CHF / Prezzo in CHF

Modell Modello	Material Materiale	Ventil Piletta	Artikel-Nr. N. di articolo	Tropfteil Scolatoio	Exkl. MWST IVA esclusa	Inkl. MWST IVA inclusa
Comfort C 75	Edelstahl, glanz Acciaio inox, lucido	3 1/2" Raumspar Salvaspazio	10.100.016.00	Links / Sinistra	A 889.–	961.–
			10.100.017.00	Rechts / Destra		
		1 1/2" Standrohr Con tubo	10.100.014.00	Links / Sinistra	A 717.–	775.–
			10.100.015.00	Rechts / Destra		

Comfort: C 90



- 1 1/2" Standrohr Con tubo ◀ 40 ▶
- 3 1/2" Raumspar Salvaspazio ◀ 45 ▶

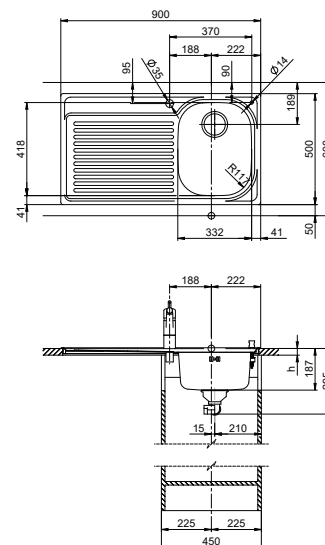

Aussenmasse / Dimensioni esterne:
 900 x 500 mm
 Ausschnitt / Intaglio:
 884 x 484 +2/-0 mm, R = ca. 5 mm
 h = >28 mm (Holz / Legno),
 h = 28 – 32 mm (Stein / Pietra)

Zeichnung als pdf / dxf und Montageanleitung siehe:
 V. disegno in formato pdf / dxf e montaggio:
 suter.ch



Varianten: Für die Einlege-Spüle Comfort mit Standard Zugknopf Prime Chrom bestellen Sie
 xx.xxx.xx.01 Standardartikel ohne Zugknopf. Reduktion CHF 24.–. Im Austausch wählen Sie den gewünschten Zugknopf auf Seite 358.
Varianti: per il lavello sottopiano Comfort con pomolo standard Prime cromato, ordinate
 xx.xxx.xx.01 – Articolo standard senza pomolo. Riduzione di CHF 24.–. In sostituzione, scegliete il pomolo desiderato a pagina 358.

Preis CHF / Prezzo in CHF

Modell Modello	Material Materiale	Ventil Piletta	Artikel-Nr. N. di articolo	Tropfteil Scolatoio	Exkl. MWST IVA esclusa	Inkl. MWST IVA inclusa	
Comfort C 90	Edelstahl, glanz Acciaio inox, lucido	3 1/2" Raumspar Salvaspazio	10.100.032.00	Links / Sinistra	A	963.–	
			10.100.033.00	Rechts / Destra			
		1 1/2" Standrohr Con tubo	10.100.030.00	Links / Sinistra	A	787.–	851.–
			10.100.031.00	Rechts / Destra			

Comfort: MCOM 90 Spezialeinleger/Lavello da incasso speciale

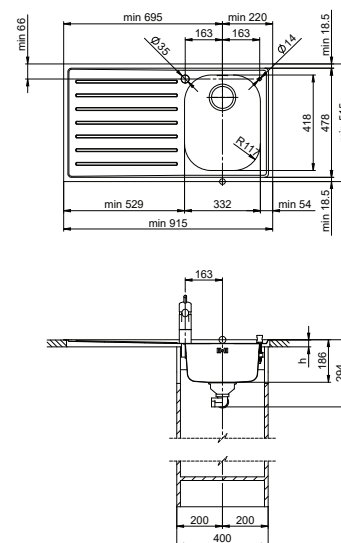

Dieser Spezialeinleger kann ohne Mehrpreis um die angegebenen Masse frei erweitert werden.
 Le dimensioni di questo lavello da incasso speciale possono essere liberamente aumentate, senza sovrapprezzo, fino alle misure indicate.

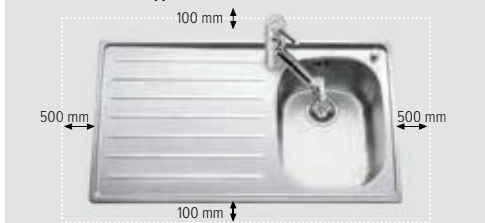

Ausschnitt/Intaglio:
 min. 890 x 490 +2/-0 mm,
 R = max. 5 mm

i Bei der Bestellung des Spezialeinlegers müssen die erforderlichen Aussenmasse mittels einer Skizze definiert werden.
 In sede di ordine di un lavello speciale è necessario fornire uno schizzo in cui siano precisate le misure esterne richieste.

Preis CHF/Prezzo in CHF

Modell Modello	Material Materiale	Ventil Piletta	Artikel-Nr. N. di articolo	Beckentiefe Profondità	Tropfteil Scolatoio	Exkl. MWST IVA esclusa	Inkl. MWST IVA inclusa
Comfort MCOM 90* Spezialeinleger Lavello da incasso speciale	Edelstahl, glanz Acciaio inox, lucido	18/10	29.001.253.00	170 mm	Links/Sinistra	D	1958.-
			29.001.254.00	170 mm	Rechts/Destra		
							2117.-

* Wird nur auf Wunsch hergestellt – 3 Wochen Lieferfrist (kein Lagerartikel)/Fabbricazione solo su richiesta con termine di consegna di 3 settimane (articolo non a magazzino)

Comfort: MCOM 34 Spezialeinleger/Lavello da incasso speciale

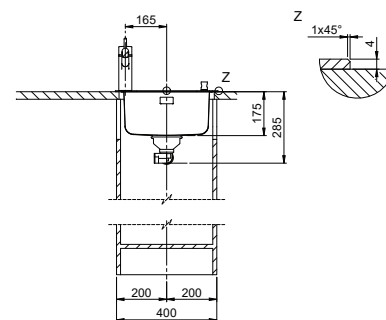
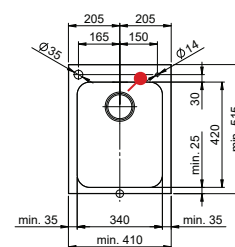

Ausschnitt / Intaglio:
min. 380 x 495 +2 / -0 mm,
R = max. 5 mm

Verdeckter Überlauf
Troppieno coperto

Obenliegendes Sieb
Griglietta superiore

26



Dieser Spezialeinleger kann ohne Mehrpreis um die angegebenen Masse frei erweitert werden.
Le dimensioni di questo lavello da incasso speciale possono essere liberamente aumentate, senza sovrapprezzo, fino alle misure indicate.



Bei der Bestellung des Spezialeinlegers müssen die erforderlichen Aussenmasse mittels einer Skizze definiert werden.
Oberfläche Breitband-Finish. Kante geschliffen mit Fase 1x45°.
In sede di ordine di un lavello speciale è necessario fornire uno schizzo in cui siano precisate le misure esterne richieste.
Superficie con finitura a nastro largo. Bordo rettificato con smusso 1x45°.

Preis CHF / Prezzo in CHF

Modell Modello	Material Materiale	Ventil Piletta	Artikel-Nr. N. di articolo	Beckentiefe Profondità	Exkl. MWST IVA esclusa	Inkl. MWST IVA inclusa
Comfort MCOM 34* Spezialeinleger Lavello da incasso speciale	Edelstahl, glanz Acciaio inox, lucido	18/10 3 1/2" Raumspar Salvaspazio	29.001.345.00	175 mm	D 1841.-	1990.-
		3 1/2" Tipo	29.001.346.00	175 mm	D 1800.-	1946.-

* Wird nur auf Wunsch hergestellt – 3 Wochen Lieferfrist (kein Lagerartikel) / Fabbricazione solo su richiesta con termine di consegna di 3 settimane (articolo non a magazzino)

Rund: R 44B



Obenliegendes Sieb
Griglietta superiore

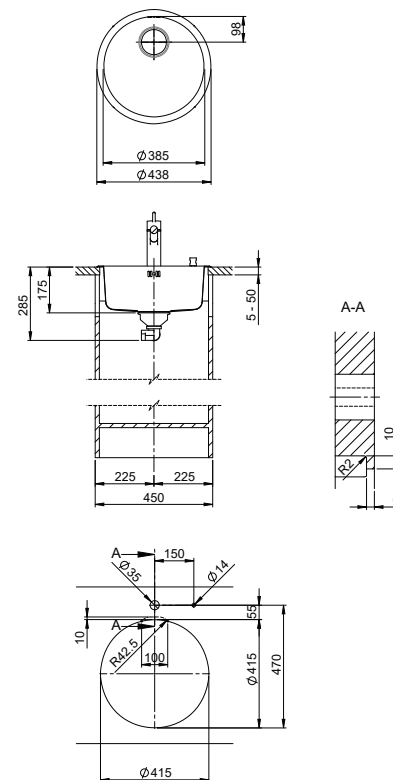

Zeichnung als pdf/dxf und Montageanleitung siehe:
V. disegno in formato pdf/dxf e montaggio:
suter.ch

! **Varianten: Für die Einlege-Spüle Rund mit Standard Zugknopf Prime Chrom bestellen Sie**
xx.xxx.xx.01 Standardartikel ohne Zugknopf. Reduktion CHF 24.-. Im Austausch wählen Sie den gewünschten Zugknopf auf Seite 358.
Varianti: per il lavello sottopiano Rund con pomolo standard Prime cromato, ordinate
xx.xxx.xx.01 – Articolo standard senza pomolo. Riduzione di CHF 24.-. In sostituzione, scegliete il pomolo desiderato a pagina 358.

Preis CHF/Prezzo in CHF

Modell Modello	Material Materiale	Ventil Piletta	Artikel-Nr. N. di articolo	Beckentiefe Profondità	Exkl. MWST IVA esclusa	Inkl. MWST IVA inclusa	
Rund R 44B	Edelstahl, glanz Acciaio inox, lucido	18 / 10	3 1/2" Raumspaar Salvaspazio	10.100.263.00	175 mm	A 948.-	1025.-
			3 1/2" Tipo	10.103.107.00	175 mm	A 907.-	980.-

Nemo: NEM N 100

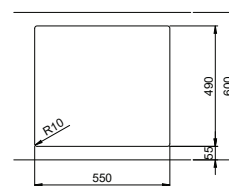
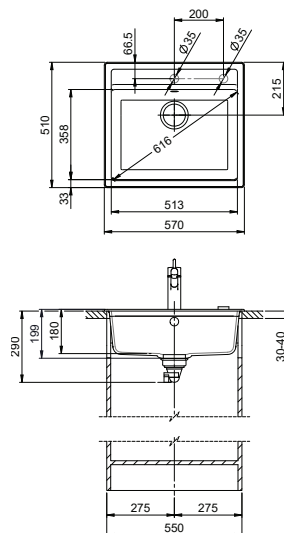
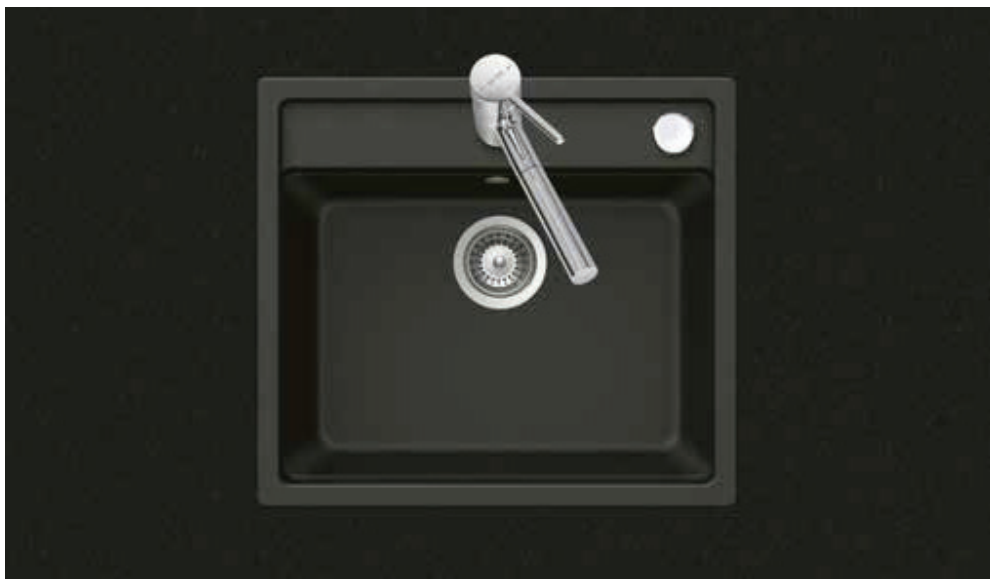
SCHOCK
CRISTALITE®

Optionales Zubehör / Accessori opzionali

312



Reinigungsset Easy Care
Kit di pulizia Easy Care
CHF 43.–/F 40.001.509.00

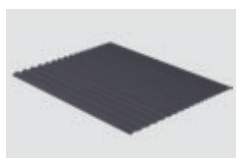

Maro Abtropfmatte aus Silikon
Maro tappetino scolapiatti in silicone
CHF 51.– 40.002.008.00

Zeichnung als pdf / dxf und Montageanleitung siehe:
V. disegno in formato pdf / dxf e montaggio:
suter.ch

**Varianten: Für die Einlege-Spüle Nemo mit Drehknopf Chrom bestellen Sie**

xx.xxx.xx.01 Standardartikel ohne Drehknopf. Reduktion CHF 24.–. Im Austausch wählen Sie den gewünschten Drehknopf auf Seite 358.

Varianti: per il lavello sottopiano Nemo con pomoli girevoli cromato, ordinate

xx.xxx.xx.01 – Articolo standard senza pomoli girevoli. Riduzione di CHF 24.–. In sostituzione, scegliete il pomoli girevoli desiderato a pagina 358.

Preis CHF / Prezzo in CHF

Modell Modello	Material Materiale	Ventil Piletta	Artikel-Nr. N. di articolo	Beckentiefe Profondità	Exkl. MWST IVA esclusa	Inkl. MWST IVA inclusa
Nemo NEM N 100*	Cristalite Plus, Nero 	3 1/2" Raumspar Salvaspazio	10.102.994.00	180 mm	B 1241.–	1342.–

*Nur mit Drehknopf lieferbar. / Disponibile solo con pomolo girevole.

Primus: PRI D 100

SCHOCK
CRISTALITE®

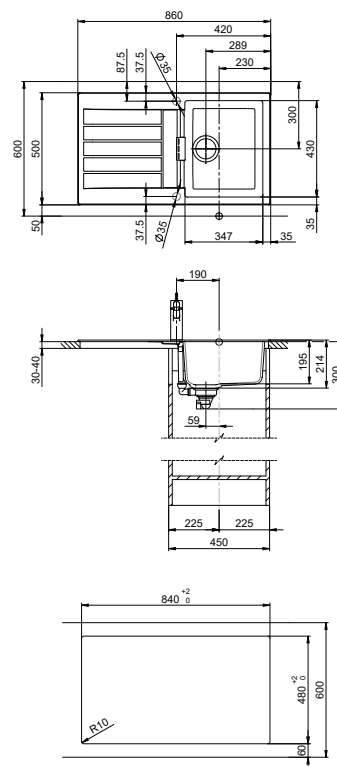

Optionales Zubehör / Accessori opzionali

312



Reinigungsset Easy Care
Kit di pulizia Easy Care
CHF 43.-/F 40.001.509.00

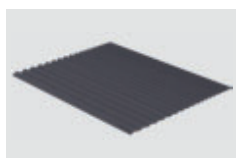

Maro Abtropfmatte aus Silikon
Maro tappetino scolapiatti in silicone
CHF 51.- 40.002.008.00

Zeichnung als pdf / dxf und Montageanleitung siehe:
V. disegno in formato pdf / dxf e montaggio:
suter.ch

! **Varianten: Für die Einlege-Spüle Primus mit Drehknopf Chrom bestellen Sie**
xx.xxx.xx.01 Standardartikel ohne Drehknopf. Reduktion CHF 24.-. Im Austausch wählen Sie den gewünschten Drehknopf auf Seite 358.
Varianti: per il lavello sottopiano Primus con pomoli girevoli cromato, ordinate
xx.xxx.xx.01 – Articolo standard senza pomoli girevoli. Riduzione di CHF 24.-. In sostituzione, scegliete il pomoli girevoli desiderato a pagina 358.

Preis CHF / Prezzo in CHF

Modell Modello	Material Materiale	Ventil Piletta	Artikel-Nr. N. di articolo	Tropfteil Scolatoio	Exkl. MWST IVA esclusa	Inkl. MWST IVA inclusa
Primus PRI D 100*	Cristalite Plus, Nero	3 1/2" Raumspar Salvaspazio	10.102.996.00	Reversibel Reversibile	B 1225.-	1324.-

*Nur mit Drehknopf lieferbar. / Disponibile solo con pomolo girevole.

Primus: PRI D 100L

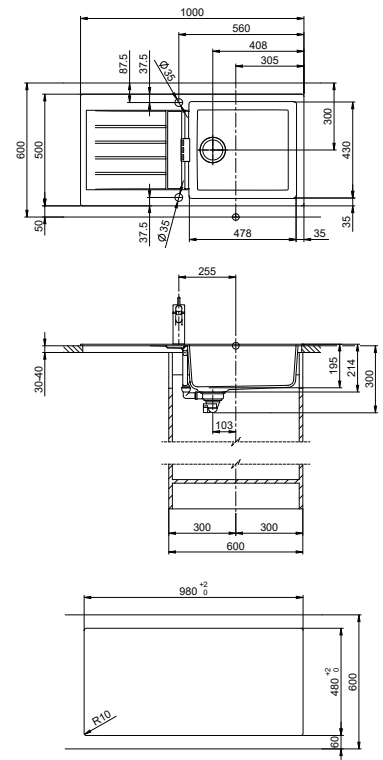
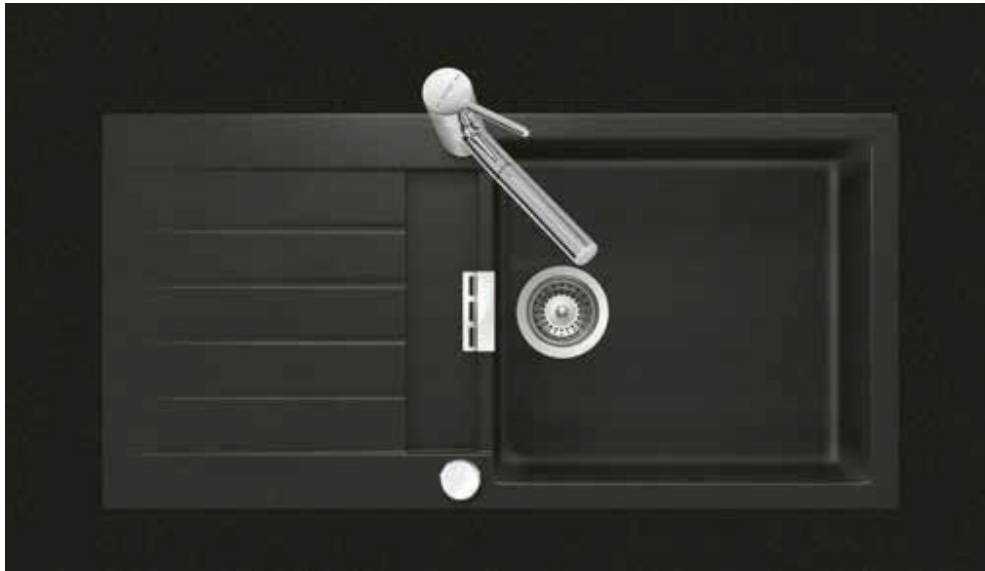
SCHOCK
 CRISTALITE®

Optionales Zubehör / Accessori opzionali

312

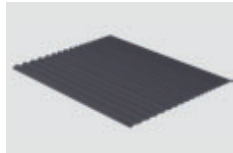
Reinigungsset Easy Care
 Kit di pulizia Easy Care
 CHF 43.–/F 40.001.509.00

Maro Abtropfmatte aus Silikon
 Maro tappetino scolapiatti in silicone
 CHF 51.– 40.002.008.00

 Zeichnung als pdf / dxf und Montageanleitung siehe:
 V. disegno in formato pdf / dxf e montaggio:
 suter.ch

Varianten: Für die Einlege-Spüle Primus mit Drehknopf Chrom bestellen Sie

xx.xxx.xx.01 Standardartikel ohne Drehknopf. Reduktion CHF 24.–. Im Austausch wählen Sie den gewünschten Drehknopf auf Seite 358.

Varianti: per il lavello sottopiano Primus con pomoli girevoli cromato, ordinate

xx.xxx.xx.01 – Articolo standard senza pomoli girevoli. Riduzione di CHF 24.–. In sostituzione, scegliete il pomoli girevoli desiderato a pagina 358.

Preis CHF / Prezzo in CHF

Modell Modello	Material Materiale	Ventil Piletta	Artikel-Nr. N. di articolo	Tropfteil Scolatoio	Exkl. MWST IVA esclusa	Inkl. MWST IVA inclusa
Primus PRI D 100L*	Cristalite Plus, Nero 	3 1/2" Raumspar Salvaspazio	10.103.000.00 	Reversibel Reversibile	B 1398.–	1511.–

*Nur mit Drehknopf lieferbar. / Disponibile solo con pomolo girevole.

Resteschalen / Inox Pad	
Vaschette / Inox Pad	310
Schneidebretter	
Taglieri	311
Universelle Accessoires	
Accessori per cucina universali	312
EVOline Qi Charger	313
EVOline One Einbausteckdose	
Presse da incasso EVOline One	314
EVOline BackFlip Einbausteckdose	
Presse da incasso EVOline BackFlip	315



Den Quva Einbauvakuumierer, respektive das Nachfolgeprodukt BORA QVac, finden Sie neu im Preisbuch Haushaltsgeräte BORA (neuer Name BORA QVac Einbauvakuumierer)

Ora trovate la macchina per sottovuoto da incasso Quva, o il prodotto successivo BORA QVac nel Catalogo prezzi elettrodomestici BORA (nuovo nome macchina per sottovuoto da incasso BORA QVac).

Resteschalen / Inox Pad / Vaschette / Inox Pad



i Weiteres Küchenzubehör siehe suter.ch
Per altri accessori per cucina vedere suter.ch

Preis CHF/Prezzo in CHF

Modell Modello	Dimensionen* Dimensioni*	Material Materiale		Artikel-Nr. N. di articolo	Exkl. MWST IVA esclusa	Inkl. MWST IVA inclusa	
1 Comfort: COM-Modelle** Modelli COM**	155 × 335 × 80	Edelstahl, glanz, poliert Acciaio inox, lucido	geloht forato	18/10 40.000.971.00	L C 106.–	115.–	
2 Zaros: ZOS 75 / ZOS 100	155 × 335 × 95	Kunststoff SAN Luran, transparent Sintetico SAN Luran, trasparente nero		40.001.004.00	L C 42.–	45.–	
Mehrpreis für Resteschale aus Edelstahl anstelle Kunststoff Sovraprezzo per vaschetta in acciaio inox invece che in sintetico						C 64.–	69.–
3 SIL 9U	87 × 226 × 22	Edelstahl, glanz, poliert Acciaio inox, lucido	geloht forato	18/10 40.000.042.00	L C 81.–	88.–	
4 Linero / Daneo / Brooklyn / Carbon	175 × 395 × 80	Edelstahl, glanz, poliert Acciaio inox, lucido	geloht forato	18/10 40.000.912.00	L C 106.–	115.–	
		Edelstahl, glanz, poliert Acciaio inox, lucido	ungeloht non forato	18/10 40.001.289.00	L C 106.–	115.–	
5 Zaros: ZOS 90 Comfort: COM 40 / COM 40U Vantis: alle Modelle / Tutti i modelli**** Silver Star: alle Modelle / Tutti i modelli****	175 × 415 × 80	Edelstahl, glanz, poliert Acciaio inox, lucido	geloht forato	18/10 40.000.914.00	L C 106.–	115.–	
		Edelstahl, glanz, poliert Acciaio inox, lucido	ungeloht non forato	18/10 40.001.290.00	L C 106.–	115.–	
6 Vantis: V 50-35IF / V 50-35U / V 50 IF/A Silver Star: SIL 50 / SIL 100 / SIL 50U	175 × 345 × 80	Edelstahl, glanz, poliert Acciaio inox, lucido	geloht forato	18/10 40.000.916.00	L C 106.–	115.–	
7 Vantis: V 11U	110 × 300 × 65	Edelstahl, glanz, poliert Acciaio inox, lucido	geloht forato	18/10 40.001.060.00	L C 106.–	115.–	
8 Inox Pad	480 × 448 × 11	Edelstahl, gebürstet Acciaio inox, spazzolato		18/10 40.001.138.00	L C 125.–	135.–	
	480 × 377 × 11	Edelstahl, gebürstet Acciaio inox, spazzolato		18/10 40.001.139.00	L C 125.–	135.–	
	480 × 418 × 11	Edelstahl, gebürstet Acciaio inox, spazzolato		18/10 40.001.140.00	L C 125.–	135.–	

*Dimensionen in mm. / Dimensioni in mm.

**Ausgenommen COM 40 und COM 40U. / Esclusi COM 40 e COM 40U.





***Ausgenommen V 11U, V 50-35IF, V 50-35U und V 50IF/A / Esclusi V 11U, V 50-35IF, V 50-35U e V 50IF/A

****Ausgenommen SIL 50, SIL 100 und SIL 50U / Esclusi SIL 50, SIL 100 e SIL 50U

Schneidebretter / Taglieri



Preis CHF / Prezzo in CHF

Modell Modello	Dimensionen* Dimensioni*	Material Materiale	Artikel-Nr. N. di articolo	Exkl. MWST IVA esclusa	Inkl. MWST IVA inclusa
Linero / Daneo / Carbon / Brooklyn / Silver Star: SIL 100	220 × 415 × 6	Glas In vetro	40.000.909.00  C	151.–	163.–
1 Zaros: ZOS 75 / ZOS 90 / ZOS 100 Comfort: COM 34 / COM 40 / COM 34U / COM 40U Vantis: alle Modelle / Tutti i modelli** Silver Star: alle Modelle / Tutti i modelli***	220 × 435 × 6	Glas In vetro	40.000.915.00  C	151.–	163.–
2 Comfort: COM 40 / COM 40U Vantis: alle Modelle / Tutti i modelli** Silver Star: alle Modelle / Tutti i modelli***	240 × 452 × 30	Holz-Schneidebrett aus Nussbaum, unbehandelt Taglieri in legno di noce, non trattato	40.001.147.00  C	151.–	163.–
3 Linero / Daneo / Carbon / Brooklyn	220 × 432 × 28	Kunststoff PE 500, weiss Sintetico PE 500, bianco	40.001.277.00  C	151.–	163.–

*Dimensionen in mm. / Dimensioni in mm. ** Ausgenommen V 11U, V 50-35IF, V 50-35U und V 50IF/A / Esclusi V 11U, V 50-35IF, V 50-35U e V 50IF/A

***Ausgenommen SIL 50, SIL 100 und SIL 50U / Esclusi SIL 50, SIL 100 e SIL 50U

Schneidebretter / Taglieri



Universelle Accessoires / Accessori per cucina universali

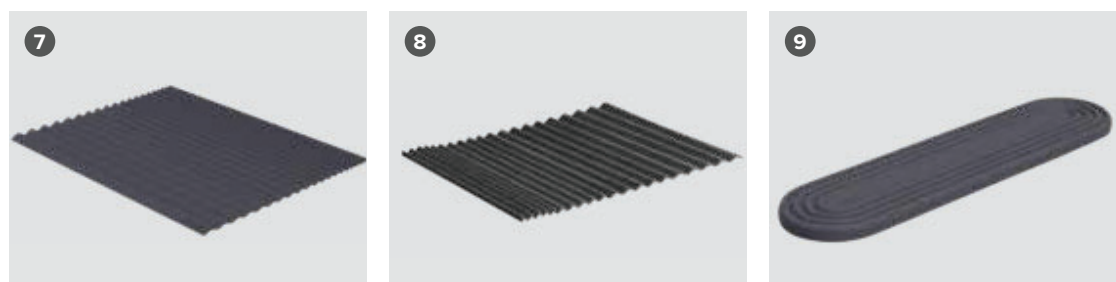

Preis CHF / Prezzo in CHF

Modell Modello	Farbe Colore	Dimensionen* Dimensioni*	Material Materiale	Artikel-Nr. N. di articolo	Exkl. MWST IVA esclusa	Inkl. MWST IVA inclusa
1 Roko	Cerulean Blue	334 × 308 × 3	TPU	40.001.886.00  C	20.–	22.–
2 Roko	Turquoise Green	334 × 308 × 3	TPU	40.001.887.00  C	20.–	22.–
3 Roko	Dark Grey	334 × 308 × 3	TPU	40.001.888.00  C	20.–	22.–
4 Pano		446 × 330 × 20	Bambus Bambù	40.002.005.00  C	38.–	41.–
5 Pasio		398 × 236 × 12	Bambus Bambù	40.001.891.00  C	20.–	22.–
6 Juna		265 × 171 × 10	Bambus Bambù	40.001.892.00  C	16.–	17.–
7 Maro Abtropfmatte Maro tappetino scolapiatti	Dark Grey	450 × 352 × 8	Silikon Silicone	40.002.008.00  C	51.–	55.–
8 Flua Abtropfmatte Flua tappetino scolapiatti	Dark Grey	352 × 265 × 7	Silikon Silicone	40.001.890.00  C	37.–	40.–
9 Movi Abtropfmatte / Kochlöffelablage Movi tappetino utensili	Dark Grey	304 × 79 × 8	Silikon Silicone	40.002.018.00  C	16.–	17.–

*Dimensionen in mm. / Dimensioni in mm.

EVOline Qi Charger



Technische Daten / Dati tecnici

Mit dem EVOline Qi Charger können mit einer einzigen Ladestation sämtliche Qi-fähigen Geräte ohne Kabel oder sonstiges Zubehör geladen werden. Der Einbau erfolgt wahlweise entweder unter der Arbeitsfläche – so dass die Ladestation unsichtbar ist – oder per Aufsatzmontage für Standardausschnitte von 80 mm. Das zu ladende Gerät wird einfach mittig auf die entsprechende Stelle gelegt – Minimalismus pur. Der Ladevorgang erfolgt per Induktion, das heisst, die Ladespule ist nur aktiv, wenn eine Verbindung zu dem zu ladenden Gerät besteht.

Con il caricatore Qi EVOline è possibile caricare i dispositivi compatibili Qi senza cavi o altri accessori. L'installazione viene eseguita sotto il piano di lavoro oppure come attacco per aperture standard di 80 mm, in modo che la stazione di carica resti nascosta. Il dispositivo da ricaricare viene semplicemente appoggiato al centro dell'area predisposta: puro minimalismo. La ricarica avviene per induzione, cioè la bobina di ricarica è attiva solo quando c'è una connessione al dispositivo da caricare.

Betriebsspannung Tensione di esercizio	9 V
Leistungsaufnahme (Betrieb) Potenza assorbita (esercizio)	max. 10 W
Leistungsaufnahme (Standby) Potenza assorbita (standby)	0,2 W
Betriebstemperaturbereich Campo di temperatura d'esercizio	17° C–25° C
Maximaltemperaturbereich Campo di temperatura massima	0° C–40° C
Einbautiefe (inkl. Stecker) Profondità di installazione (spina compresa)	28 mm
Montage / Befestigung Montaggio / fissaggio	unsichtbar unterhalb der Arbeitsplatte oder Aufsatzmontage Invisibile sotto il piano di lavoro o come attacco per aperture

Lieferumfang

- Qi-Ladespule nach WPC-Standard Spec. 1.2.2 «Qi»
- USB-Netzteil mit Eurostecker 2-polig (230 V), USB-Verbindungskabel 1 m
- Bedienungs- und Montageanleitung

Corredo di fornitura

- Bobina di ricarica Qi secondo le specifiche standard WPC 1.2.2 «Qi»
- Alimentatore USB con spina europea, cavo di collegamento USB 1 m
- Istruzioni d'uso e di montaggio

i Bei unsichtbarem Einbau unterhalb der Arbeitsfläche: Die Oberflächen dürfen nicht aus stromleitfähigen Materialien (z.B. alle Metalle, inkl. Edelstahl) bestehen. Empfehlung bei Naturstein: Vor Einbau / Fräsen eine Probe machen, da Spuren von Eisenerz enthalten sein können. Verbleibende Arbeitsplattenstärke bis max. 3 mm im Ausschnittbereich beachten (siehe Zeichnung).

In caso d'installazione sotto il piano di lavoro: le superfici non devono essere fatte di materiali conduttivi (ad es. tutti i metalli, acciaio inox compreso). Raccomandazione per quanto riguarda la pietra naturale: fare una prova prima del montaggio/della fresatura, poiché potrebbero esserci delle tracce di minerale ferifero. Osservare uno spessore rimanente del piano di lavoro fino a un max. di 3 mm nella zona dell'intaglio (vedi disegno).

i Es kann erforderlich sein, Smartphone-Hüllen, Back Covers, Wallets oder Etuis zu entfernen, um den Ladevorgang sicherzustellen. Potrebbe essere necessario rimuovere le custodie, le retrocopertine, i portafogli o gli astucci degli smartphone per garantire la ricarica.

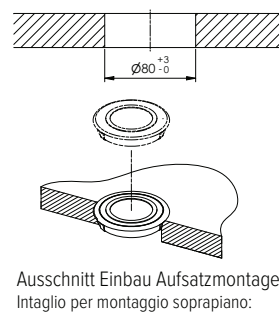
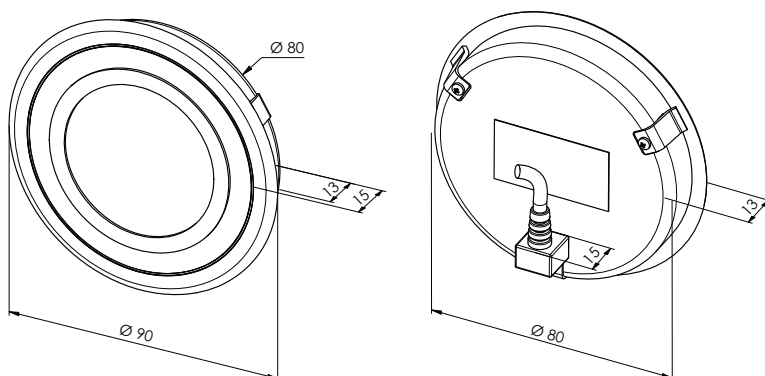

Ausschnitt Einbau Aufsatzmontage:
Intaglio per montaggio soprapiano:

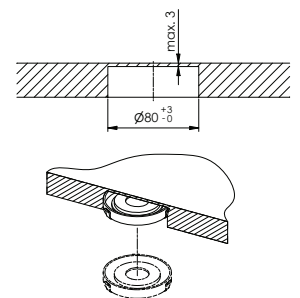

Ausschnitt unsichtbarer Einbau
(unterhalb der Arbeitsplatte):
Intaglio per montaggio non visibile
(sotto il piano di lavoro):

Preis CHF / Prezzo in CHF

Modell Modello	Beschreibung Descrizione	Ausführung Finitura	Artikel-Nr. N. di articolo	Exkl. MWST IVA esclusa	Inkl. MWST IVA inclusa
Qi Charger	Qi-Ladestation zum Einbau in Küchenarbeitsplatten Stazione di ricarica Qi per l'installazione in piani di lavoro di cucine	Kunststoff, schwarz Plastica, nera	40.002.437.00  H	293.–	317.–

EVOline One Einbausteckdose / Presa da incasso EVOline One



Technische Daten/Dati tecnici

Die Einbausteckdose EVOline One ist ein kompakter Stromzugang, der sich in jedes Gestaltungskonzept harmonisch integriert. Und das auf eine sehr platzsparende und dezente Weise. Ob in komplett schwarzer Ausführung oder mit Edelstahleinlage: Beide Versionen lassen sich dank den einfach wechselbaren Moduleinsätzen der jeweiligen Anforderung anpassen. Das neue, patentierte Montagesystem hält ab einer Frontstärke von 9 mm. Die Einbautiefe beträgt 50 mm.

La presa da incasso EVOline One è un compatto erogatore di corrente che si integra armoniosamente in qualsiasi configurazione di cucina, e lo fa con un minimo ingombro e con molta discrezione. In versione completa color nero oppure con inserto in acciaio inox, entrambe le versioni sono adattabili alle rispettive esigenze grazie alla semplice intercambiabilità degli inserti modulari. Il nuovo sistema brevettato di montaggio assicura una perfetta tenuta a partire da uno spessore di pannello frontale di 9 mm. La profondità di montaggio è di 50 mm.

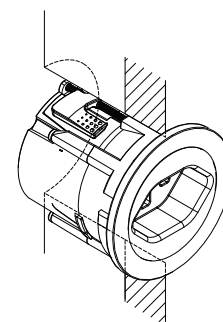
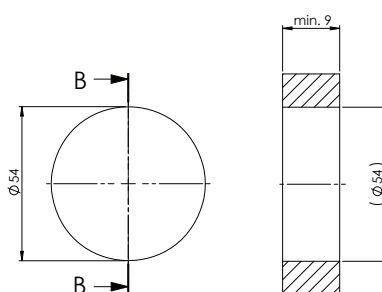
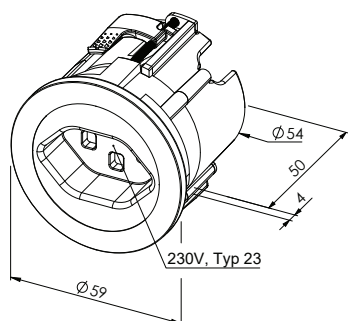

Anschlussspannung Tensione di attacco	230V
Nennstrom maximal Corrente nominale max	16 A
Abmessungen Dimensioni	Ø 59 mm
Abmessungen Dicke Dimensioni Spessore	4 mm
Einbautiefe Profondità di montaggio	50 mm
Blendenbohrung Foratura pannello	Ø 54 mm
Netzanschluss Allacciamento alla rete	Festes Netzanschlusskabel 2,5 m, ohne Netzanschlussstecker (16 A, Typ 23 oder Direktanschluss) Cavo di alimentazione di 2,5 m, senza connettore (16 A, tipo 23 o allacciamento diretto)
Montage/Befestigung Montaggio/fissaggio	von vorne/dal davanti
Lieferumfang - Steckdose, inkl. Anschlusskabel 2,5 m - Ring ohne Deckel - Ring mit Deckel (360° drehbar)	Corredo di fornitura - Presa con cavo di allacciamento di 2,5 m - Anello senza coperchio - Anello con coperchio (rotante di 360°)



1

⚡ 230V, 16A Anschluss bauseits
230V, 16A Collegamento sul cantiere

Preis CHF/Prezzo in CHF

Modell Modello	Beschreibung Descrizione	Ausführung Finitura	Artikel-Nr. N. di articolo	Exkl. MWST IVA esclusa	Inkl. MWST IVA inclusa
EVOline One	Einbausteckdose zum Einbau in Küchenmöbel ab Frontstärke 9 mm. Gesamteinbautiefe: 50 mm. Presa da incasso per montaggio nel mobile della cucina a partire da uno spessore frontale di 9 mm. Profondità totale: 50 mm.	1 Kunststoff schwarz Plastica color nero	40.002.165.00  H	114.–	123.–
		2 Kunststoff schwarz, mit Edelstahleinlage Plastica color nero, con inserto in acciaio inox	40.002.166.00  H	141.–	152.–

EVOline BackFlip Einbausteckdose / Presa da incasso EVOline BackFlip



Technische Daten/Dati tecnici

Beschreibung: Immer verfügbar, aber nie im Weg. Der EVOline BackFlip ist eine elegante Einbaulösung für die Küche. Geschlossen verbirgt er sich gekonnt in der Arbeitsplatte, kein Wasser kann in die elektrischen Systeme eindringen. Mit einem Finger angetippt, dreht er sich um 180 Grad und präsentiert seine nützlichen Funktionen: Zwei Steckdosen und ein USB-Charger werden sichtbar und liegen so hoch über der Arbeitsfläche, so dass sie vor Wasser geschützt sind. Die geringe Einbautiefe von nur 59 mm ermöglicht eine Montage über Schubladen oder fest installierten Küchengeräten.

Descrizione: Sempre disponibile, ma senza mai essere d'impiccio. L'EVOline BackFlip è un'elegante soluzione integrata per la cucina. Quando è chiuso esso rimane perfettamente nascosto nel piano di lavoro, in modo che l'acqua non possa penetrare nell'impianto elettrico. Toccatolo con un dito esso ruota di 180 gradi, rendendo visibili le sue utili funzioni: due prese di corrente e un'unità di ricarica USB che si elevano al di sopra del piano di lavoro in modo da essere protetti dall'acqua. La profondità di incasso di soli 59 mm ne consente il montaggio al di sopra di cassetti o di apparecchi per cucina fissi.

Gerätemasse (Breite, Tiefe, Höhe)
Dimensioni (larghezza, profondità, altezza)

225.2 × 104.8 × 59 mm

Einbauoptionen/Opzioni d'installazione

Flächenbündig oder aufgesetzt
A filo top o soprapiano

Eingangsspannung / Tensione di ingresso

230 V

Ausgangsspannung / Tensione di uscita

230 V

Spannungsart / Tipo di tensione

AC

Bestückung / Dotazione

2 × Steckdose, 0°, 16 A, Typ 23
1 × USB-Charger Typ C* (mit Ladefunktion, ohne PC-Anbindung. Für handelsübliche Geräte wie Mobiltelefone, Tablets und andere mobile Geräte)
2 prese di corrente, 0°, 16 A, tipo 23
1 porta USB tipo C* (con funzione di ricarica senza collegamento con PC. Per dispositivi di uso corrente come cellulari, tablet e altri dispositivi mobili)

Netzanschluss / Allacciamento alla rete

Festes Netzanschlusskabel 2,0 m, ohne Netzanschlussstecker (16 A, Typ 23 oder Direktanschluss)
Cavo di alimentazione di 2,0 m, senza connettore (16 A, tipo 23 o allacciamento diretto)



i Alle Modelle sind auf USB-Charger Typ C umgestellt.
Tutti i modelli sono convertiti per il caricatore USB del tipo C.

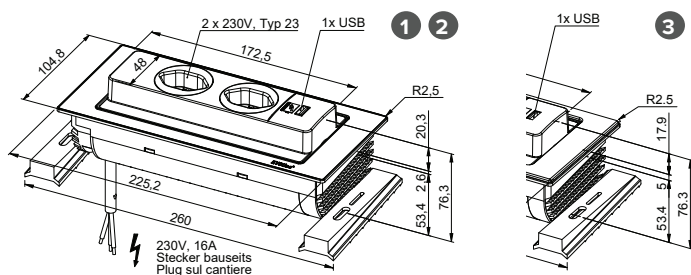

Ausschnitt für flächenbündigen Einbau / Intaglio per montaggio a filo top

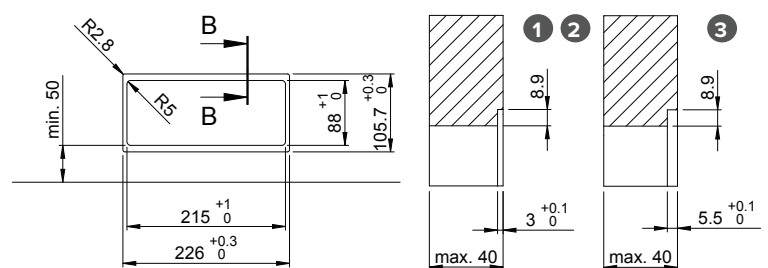

Ausschnitt für Aufsatzmontage / Intaglio per incasso con montaggio soprapiano

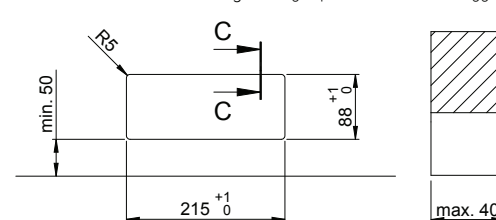

i Netzanschlussstecker (16 A, Typ 23 oder Direktanschluss) nicht im Lieferumfang
Connettore di rete (16 A, tipo 23 o per connessione diretta) non incluso nel corredo di fornitura

Preis CHF/Prezzo in CHF

Modell Modello	Beschreibung Descrizione	Ausführung Finitura	Artikel-Nr. N. di articolo	Exkl. MWST IVA esclusa	Inkl. MWST IVA inclusa
EVOline BackFlip	Einbausteckdose zum Einbau in Arbeitsplatten bis 40 mm Stärke Gesamteinbautiefe: 59 mm, Dreheinsatz Kunststoff schwarz Presa da incasso per piani di lavoro con spessore fino a 40 mm Profondità totale di incasso: 59 mm, inserto girevole in plastica nera	1 Edelstahl, massiv Acciaio inox, massiccio	40.002.500.00 H	271.–	293.–
		2 Edelstahl, schwarz matt Acciaio inox, nero opaco	40.002.495.00 H	336.–	363.–
		3 Glas schwarz Vetro nero	40.002.501.00 H	422.–	456.–

* Die Ladefunktion des USB-Chargers kann auf Grund der Vielzahl der Anbieter und Geräte nicht in jedem Fall garantiert werden.
Data la grande varietà di produttori e di dispositivi, non è possibile garantire la funzionalità dell'unità di ricarica USB in ogni singolo caso.



Suter	
Suter Merano	318
Suter Areo	318
Suter Meno	319
Suter Evio	320 – 321
Suter Lumo	321
Suter Eco Plus	321
Suter Omero	322
Suter Devo	322
Suter Vamos	322

KWC	
Exklusiv bei Suter / Un'esclusiva di Suter	
Luna-E	323 – 324

KWC	
Inox	325
Zoe	325
Livello	325
Ono	326
Bistro E	326
Bevo	326 – 327
Domo	327 – 328
Suno	328
Ava	329
Wamas	329
Isla	330
Fit	330
Kaltwasserstandventil	
Rubinetto a pressione per acqua fredda	330

Gessi	
Exklusiv bei Suter / Un'esclusiva di Suter	
Segno	331 – 332
Stelo	332 – 333
Officine Gessi	334
SU & GIU	334
Officine V	334
Soletto	334
Lunis	335
Divino	335

Laufen	
Exklusiv bei Suter / Un'esclusiva di Suter	
Twin	336
Sento	336
Epoc	336 – 337
Pino	337

Laufen	
Twin	338
Twin S	338
Twin	339
Twinplus	339
Twinplus Slim	339
Cityplus	340
Triathlon	340
Simichrom	340
Siminox	340
Swap	341
Swisstap	341
Class	341

Hansgrohe	
Axor Citterio	342
Talis M54	342 – 343
Talis S	344
Zesis M33-160	344
Zesis M33-150	344
Zesis M33-150 CoolStart	345
Logis	345

Dornbracht	
Exklusiv bei Suter / Un'esclusiva di Suter	
Tara Ultra	346
Sync	346
Koya	346 – 347

Dornbracht	
Tara Ultra	348
Mem	348
Meta Square	349
Sync	349

Grohe	
Essence	350
Minta	350
Concetto	351
Eurosmart	351

Energieetikette / Etichetta energetica

Die Energieetikette für Sanitärprodukte zeigt auf einen Blick, ob Armaturen wenig Energie verbrauchen (Klasse A) oder viel (Klasse G). In diesem Katalog werden die Armaturen mit dem entsprechenden Pfeil und der Kategorie markiert. Die Werte der Energieetikette für die Küchenmischer beziehen sich immer auf die Ausführungen mit Zubehör im Auslieferungszustand.

L'etichetta energetica applicata sugli articoli sanitari fornisce un'indicazione immediata del minore (classe A) o maggiore (classe G) consumo energetico di una rubinetteria. In questo catalogo tutte le rubinetterie sono contrassegnate con la rispettiva freccia e categoria.

I valori di efficienza energetica relativi ai miscelatori per cucina si riferiscono sempre a versioni con accessori nello stato di fornitura.

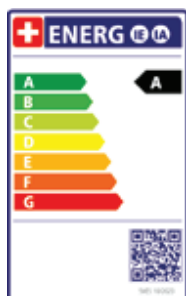

- A** Energieeffizienzklasse A / Classi di efficienza energetica A
- B** Energieeffizienzklasse B / Classi di efficienza energetica B
- C** Energieeffizienzklasse C / Classi di efficienza energetica C
- D** Energieeffizienzklasse D / Classi di efficienza energetica D

- E** Energieeffizienzklasse E / Classi di efficienza energetica E
- F** Energieeffizienzklasse F / Classi di efficienza energetica F
- G** Energieeffizienzklasse G / Classi di efficienza energetica G

SUTER

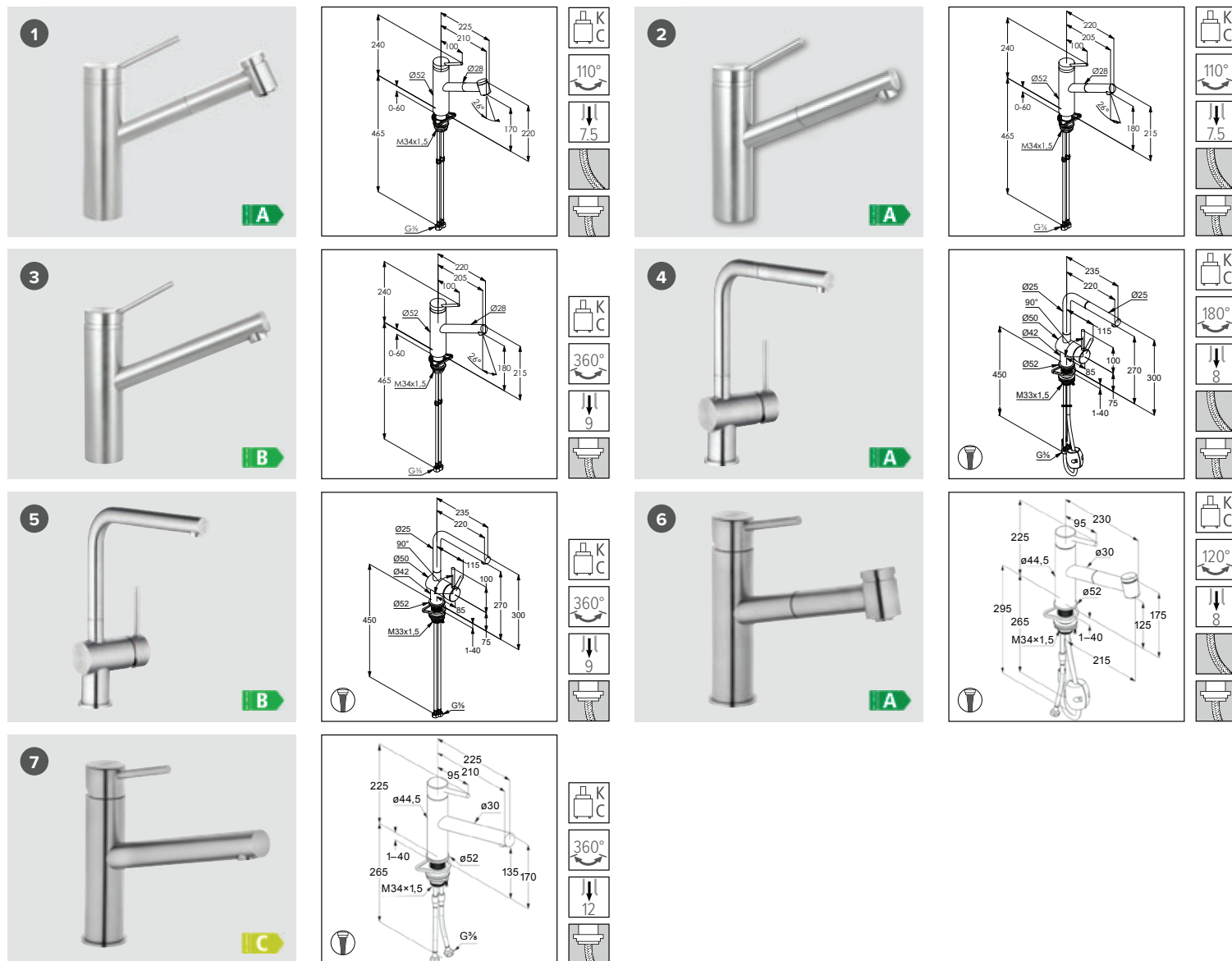

i Passende Dispenser und Zugknöpfe
in allen Oberflächen auf den
Seiten 353–360.
Dispenser e pomoli abbinabili a tutte le superfici
alle pagine 353–360.

Preis CHF/Prezzo in CHF

Name Nome	Modell Modello	Version/Oberfläche Versione/Superficie	Artikel-Nr. N. di articolo	Exkl. MWST IVA esclusa	Inkl. MWST IVA inclusa
1 Suter Merano	Auszugsbrause Doccia estraibile	☆ Edelstahl, massiv Acciaio inox, massiccio	40.001.447.00 L H	909.–	983.–
2 Suter Merano	Zugauslauf Boccaglio estraibile	☆ Edelstahl, massiv Acciaio inox, massiccio	40.001.446.00 L H	872.–	943.–
3 Suter Merano	Schwenkauslauf Braccio girevole	Edelstahl, massiv Acciaio inox, massiccio	40.001.445.00 L H	788.–	852.–
4 Suter Areo	Zugauslauf Boccaglio estraibile	Ⓢ Side lever L/Edelstahl, massiv Side lever L/Acciaio inox, massiccio	40.002.212.00 L H	620.–	670.–
5 Suter Areo	Schwenkauslauf Braccio girevole	Ⓢ Side lever L/Edelstahl, massiv Side lever L/Acciaio inox, massiccio	40.002.213.00 L H	477.–	516.–
6 Suter Areo	Auszugsbrause Doccia estraibile	Ⓢ Top lever/Edelstahl, massiv Top lever/Acciaio inox, massiccio	40.002.133.00 L H	598.–	646.–
7 Suter Areo	Schwenkauslauf Braccio girevole	Ⓢ Top lever/Edelstahl, massiv Top lever/Acciaio inox, massiccio	40.002.132.00 L H	472.–	510.–

SUTER

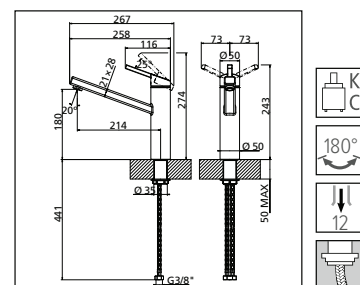
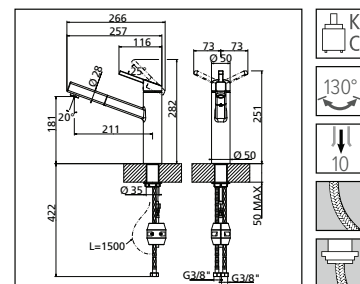
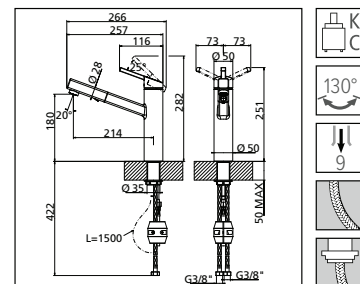
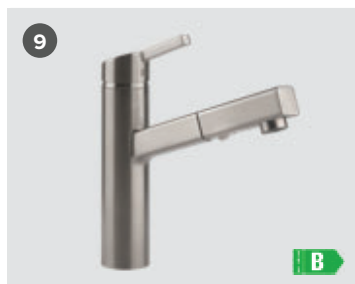

Kartusche keramisch
Cartuccia a dischi ceramic

Schwenkbereich
Raggio d'azione

Durchfluss l/min. (3 bar)
Scarico l/min. (3 bar)

Auslauf mit Nylonschlauch
Doccia con flessibile in nylon

Auslauf mit Metallschlauch
Doccia con flessibile in metallo

Flexible Anschlussschläuche
Raccordi flessibili

Mit Laminarstrahl
Con getto laminare

Preis CHF/Prezzo in CHF

Name Nome	Modell Modello	Version / Oberfläche Versione / Superficie	Artikel-Nr. N. di articolo	Exkl. MWST IVA esclusa	Inkl. MWST IVA inclusa
8	Auszugsbrause Doccia estraibile	Chrom Cromato	40.002.387.00 L H	492.–	532.–
9 Suter Meno		Edelstahl-Finish Acciaio inox-finish	40.002.388.00 L H	618.–	668.–
10		Pulverbeschichtung schwarz, matt Rivestimento con polvere nero, opaco	40.002.389.00 L H	618.–	668.–
11	Zugauslauf Boccaglio estraibile	Chrom Cromato	40.002.384.00 L H	431.–	466.–
12 Suter Meno		Edelstahl-Finish Acciaio inox-finish	40.002.385.00 L H	556.–	601.–
13		Pulverbeschichtung schwarz, matt Rivestimento con polvere nero, opaco	40.002.386.00 L H	556.–	601.–
14	Schwenkauslauf Braccio girevole	Chrom Cromato	40.002.381.00 L H	345.–	373.–
15 Suter Meno		Edelstahl-Finish Acciaio inox-finish	40.002.382.00 L H	465.–	503.–
16		Pulverbeschichtung schwarz, matt Rivestimento con polvere nero, opaco	40.002.383.00 L H	465.–	503.–

☆ Mit Nylonschlauch / Con flessibile in nylon

SUTER

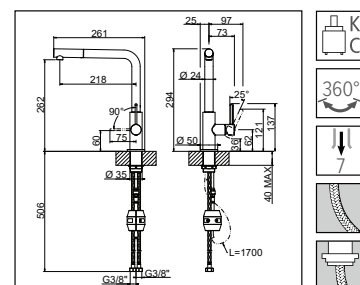
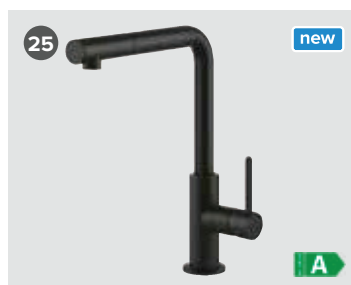
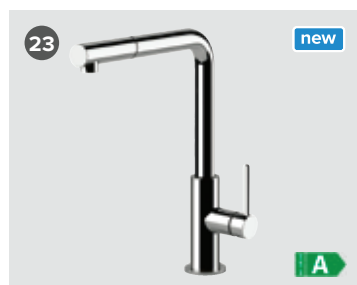
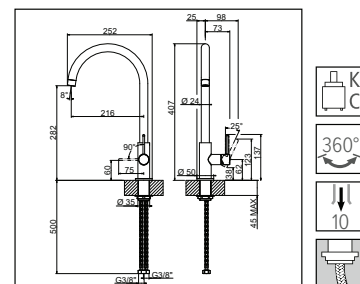
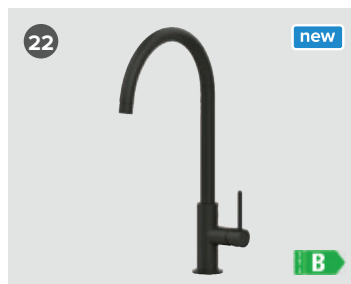
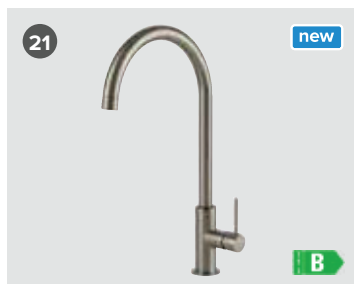
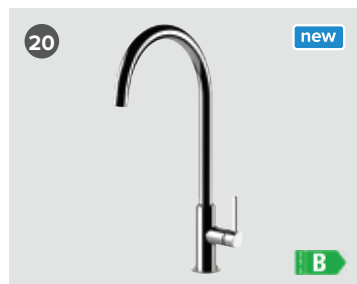
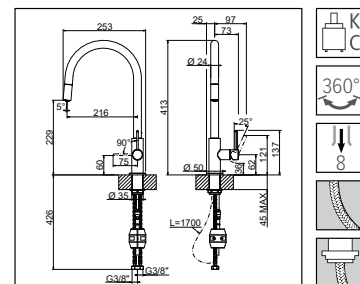
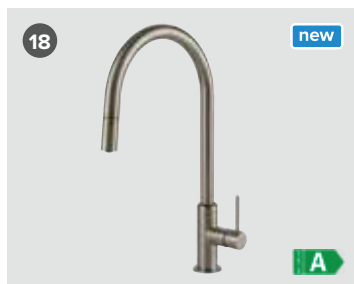

i Passende Dispenser und Zugknöpfe in allen Oberflächen auf den Seiten 353–360.
Dispenser e pomoli abbinabili a tutte le superfici alle pagine 353–360.

Kartusche keramisch
Cartuccia a dischi ceramic

Schwenkbereich
Raggio d'azione

Durchfluss l/min. (3 bar)
Scarico l/min. (3 bar)

Auslauf mit Nylonschlauch
Doccia con flessibile in nylon

Auslauf mit Metallschlauch
Doccia con flessibile in metallo

Flexible Anschlusschläuche
Raccordi flessibili

Mit Laminarstrahl
Con getto laminare

Preis CHF/Prezzo in CHF

Name Nome	Modell Modello	Version / Oberfläche Versione / Superficie	Artikel-Nr. N. di articolo	Exkl. MWST IVA esclusa	Inkl. MWST IVA inclusa
17	Zugauslauf Boccaglio estraibile	Side lever C / Chrom Side lever C / Cromato	40.002.718.00 L H	398.–	430.–
18		Side lever C / Edelstahl-Finish Side lever C / Acciaio inox-finish	40.002.719.00 L H	469.–	507.–
19		Side lever C / Pulverbeschichtung schwarz, matt Side lever C / Rivestimento con polvere nero, opaco	40.002.720.00 L H	469.–	507.–
20	Schwenkauslauf Goulot orientable	Side lever C / Chrom Side lever C / Cromato	40.002.715.00 L H	346.–	374.–
21		Side lever C / Edelstahl-Finish Side lever C / Acciaio inox-finish	40.002.716.00 L H	397.–	429.–
22		Side lever C / Pulverbeschichtung schwarz, matt Side lever C / Rivestimento con polvere nero, opaco	40.002.717.00 L H	397.–	429.–
23	Zugauslauf Boccaglio estraibile	Side lever L / Chrom Side lever L / Cromato	40.002.710.00 L H	398.–	430.–
24		Side lever L / Edelstahl-Finish Side lever L / Acciaio inox-finish	40.002.711.00 L H	469.–	507.–
25		Side lever L / Pulverbeschichtung schwarz, matt Side lever L / Rivestimento con polvere nero, opaco	40.002.713.00 L H	469.–	507.–

☆ Mit Nylonschlauch / Con flessibile in nylon

SUTER



Preis CHF/Prezzo in CHF

Name Nome	Modell Modello	Version / Oberfläche Versione / Superficie	Artikel-Nr. N. di articolo	Exkl. MWST IVA esclusa	Inkl. MWST IVA inclusa
26	Suter Evio Schwenkauslauf Goulot orientable	Side lever C / Chrom Side lever C / Cromato	40.002.707.00 L H	346.–	374.–
27		Side lever L / Edelstahl-Finish Side lever L / Acciaio inox-finish	40.002.708.00 L H	397.–	429.–
28		Side lever L / Pulverbeschichtung schwarz, matt Side lever L / Rivestimento con polvere nero, opaco	40.002.709.00 L H	397.–	429.–
29	Suter Evio Zugauslauf Boccaglio estraibile ☆	Side lever L / Edelstahl, massiv Side lever L / Acciaio inox, massiccio	40.002.714.00 L H	565.–	611.–
30	Suter Evio Schwenkauslauf Goulot orientable	Side lever L / Edelstahl, massiv Side lever L / Acciaio inox, massiccio	40.002.712.00 L H	449.–	485.–
31	Suter Lumo Auszugsbrause Doccia estraibile ☆	Chrom Cromato	40.001.651.00 L H	495.–	535.–
32	Suter Lumo Schwenkauslauf Braccio girevole	Chrom Cromato	40.001.652.00 L H	345.–	373.–
33	Suter Eco Plus Auszugsbrause Doccia estraibile ☆	Chrom Cromato	40.001.534.00 L H	491.–	531.–
34	Suter Eco Plus* Schwenkauslauf Braccio girevole	Chrom Cromato	40.001.535.00 L H	298.–	322.–

☆ Mit Nylonschlauch / Con flessibile in nylon

*Modell ist mit Befestigungs-Set mit Befestigungsbügel (Hufeisen) ausgerüstet. Bei der Montage die mitgelieferte Verstärkungsplatte (Dreieck) verwenden.

*Il modello è dotato di set di fissaggio con staffa di fissaggio (a forma di ferro di cavallo). Utilizzare la piastra di rinforzo in dotazione (triangolo) per il montaggio.

SUTER

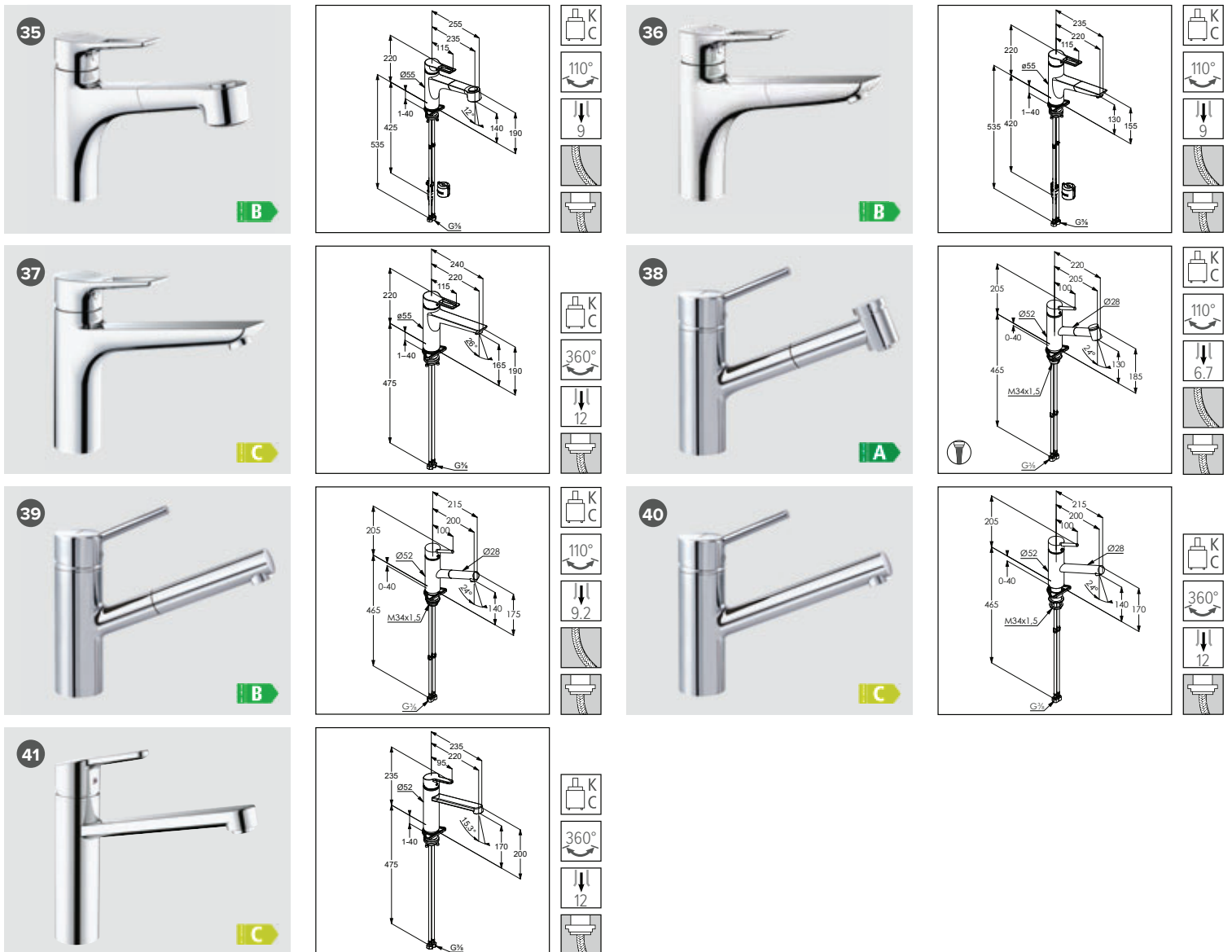

i Passende Dispenser und Zugknöpfe
in allen Oberflächen auf den
Seiten 353–360.
Dispenser e pomoli abbinabili a tutte le superfici
alle pagine 353–360.

Preis CHF/Prezzo in CHF

Name Nome	Modell Modello	Version/Oberfläche Versione/Superficie	Artikel-Nr. N. di articolo	Exkl. MWST IVA esclusa	Inkl. MWST IVA inclusa
35 Suter Omero	Auszugsbrause Doccia estraibile	☆ Chrom Cromato	40.002.499.00 L H	507.–	548.–
36 Suter Omero	Zugauslauf Boccaglio estraibile	☆ Chrom Cromato	40.002.214.00 L H	467.–	505.–
37 Suter Omero	Schwenkauslauf Braccio girevole	Chrom Cromato	40.002.215.00 L H	373.–	403.–
38 Suter Devo	Auszugsbrause Doccia estraibile	Ⓢ Chrom Cromato	40.001.648.00 L H	448.–	484.–
39 Suter Devo	Zugauslauf Boccaglio estraibile	☆ Chrom Cromato	40.001.649.00 L H	380.–	411.–
40 Suter Devo	Schwenkauslauf Braccio girevole	Chrom Cromato	40.001.650.00 L H	298.–	322.–
41 Suter Vamos	Schwenkauslauf Braccio girevole	Chrom Cromato	40.002.420.00 L H	256.–	277.–

KWC Exklusiv bei Suter/Un'esclusiva di Suter

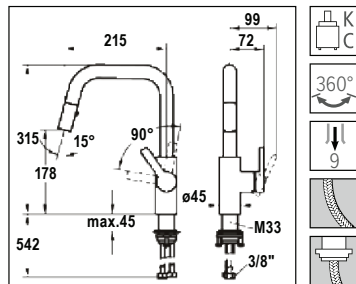
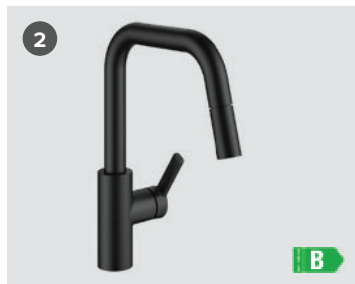
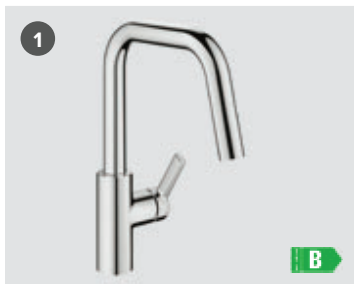

- K C
- 360°
- 9
-
-

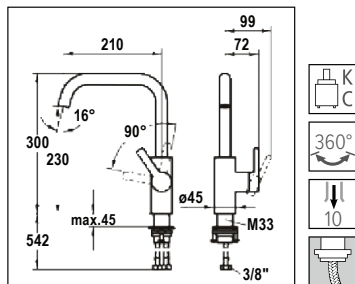
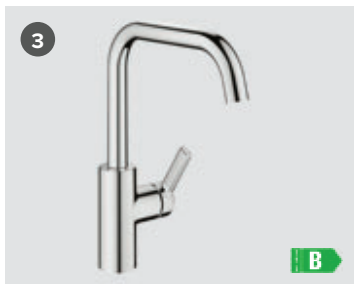

- K C
- 360°
- 10
-
-

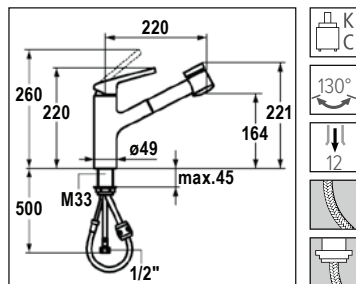
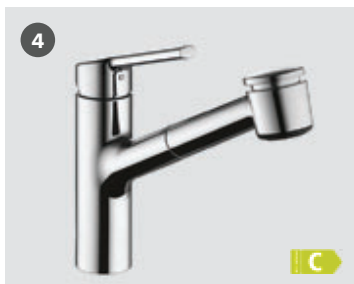

- K C
- 130°
- 12
-
-

Kartusche keramisch
Cartuccia a dischi ceramic

Schwenkbereich
Raggio d'azione

Durchfluss l/min. (3 bar)
Scarico l/min. (3 bar)

Auslauf mit Nylonschlauch
Doccia con flessibile in nylon

Auslauf mit Metallschlauch
Doccia con flessibile in metallo

Flexible Anschlussschläuche
Raccordi flessibili

Mit Laminarstrahl
Con getto laminare

Preis CHF/Prezzo in CHF

	Name Nome	Modell Modello	Version / Oberfläche Versione / Superficie	Artikel-Nr. N. di articolo	Exkl. MWST IVA esclusa	Inkl. MWST IVA inclusa
1	Luna-E	Auszugsbrause Doccia estraibile	Side lever L/Chrom	40.002.135.00	L G 410.–	443.–
2			Side lever L/Pulverbeschichtung schwarz, matt	40.002.220.00	L G 582.–	629.–
3	Luna-E	Schwenkauslauf Braccio girevole	Side lever L/Chrom	40.002.134.00	L G 315.–	341.–
4	Luna-E	Auszugsbrause Doccia estraibile	Top lever/Chrom	40.001.718.00	L G 388.–	419.–
5			Top lever/Pulverbeschichtung schwarz, matt	40.002.136.00	L G 519.–	561.–

☆ Mit Nylonschlauch / Con flessibile in nylon

KWC Exklusiv bei Suter / Un'esclusiva di Suter

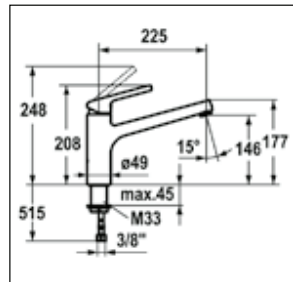
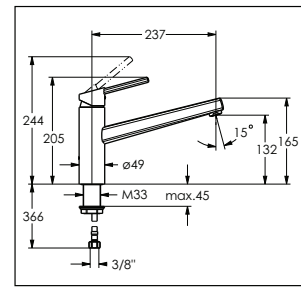
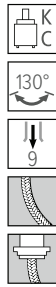
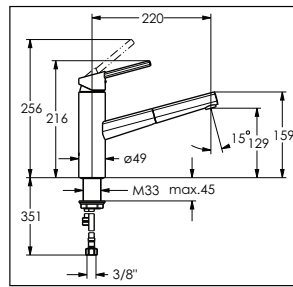

i Passende Dispenser und Zugknöpfe in allen Oberflächen auf den Seiten 353–360.
Dispenser e pomoli abbinabili a tutte le superfici alle pagine 353–360.

Preis CHF / Prezzo in CHF

Name Nome	Modell Modello	Version / Oberfläche Versione / Superficie	Artikel-Nr. N. di articolo	Exkl. MWST IVA esclusa	Inkl. MWST IVA inclusa
6 Luna-E	Zugauslauf Boccaglio estraibile	Top lever / Edelstahl, massiv Top lever / Acciaio inox, massiccio	40.001.721.00 L G	515.–	557.–
7 Luna-E	Schwenkauslauf Braccio girevole	Top lever / Chrom Top lever / Cromato	40.001.720.00 L G	292.–	316.–
8 Luna-E	Schwenkauslauf Braccio girevole	Top lever / Edelstahl, massiv Top lever / Acciaio inox, massiccio	40.001.722.00 L G	417.–	451.–

☆ Mit Nylonschlauch / Con flessibile in nylon

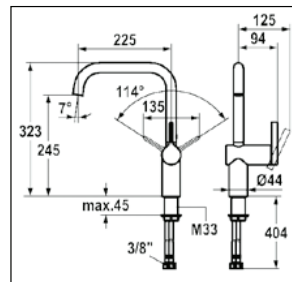
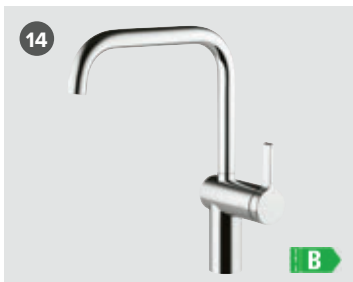
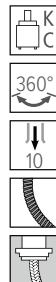
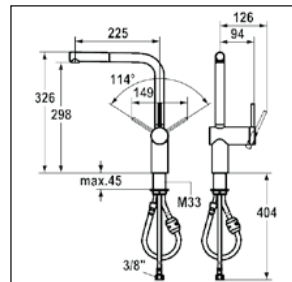
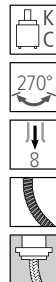
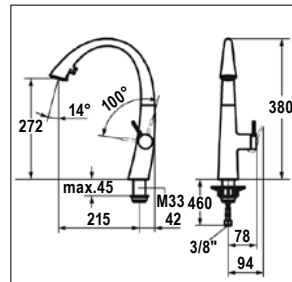
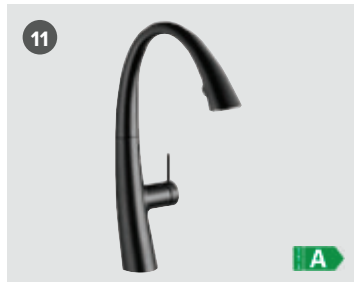
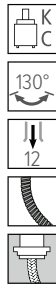
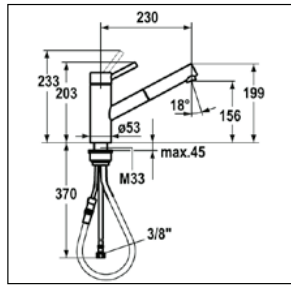

Kartusche keramisch
Cartuccia a dischi ceramic

Auslauf mit Metallschlauch
Doccia con flessibile in metallo

Schwenkbereich
Raggio d'azione

Flexible Anschlussschläuche
Raccordi flessibili

Durchfluss l/min. (3 bar)
Scarico l/min. (3 bar)

Mit Laminarstrahl
Con getto laminare

Auslauf mit Nylonschlauch
Doccia con flessibile in nylon

Preis CHF/Prezzo in CHF

Name Nome	Modell Modello	Version/Oberfläche Versione/Superficie	KWC-Nr. N. di KWC	Artikel-Nr. N. di articolo	Exkl. MWST IVA esclusa	Inkl. MWST IVA inclusa
9 Inox	Auszugs-Neoperl Boccaglio estraibile	* Edelstahl, massiv Acciaio inox, massiccio	10.271.103.700FL	40.000.945.00	L C	854.– 923.–
10 Zoe	Auszugsbrause Doccia estraibile	Chrom Cromato	10.201.102.000FL	40.001.996.00	L C	696.– 752.–
11		Pulverbeschichtung schwarz, matt Rivestimento con polvere nero, opaco	10.201.102.176FL	40.002.140.00	L C	1042.– 1126.–
12 Livello	Zugauslauf Boccaglio estraibile	Chrom Cromato	10.231.103.000FL	40.001.039.00	L G	566.– 612.–
13		Edelstahl, massiv Acciaio inox, massiccio	10.231.103.700FL	40.001.041.00	L G	893.– 965.–
14 Livello	Schwenkauslauf Braccio girevole	Chrom Cromato	10.231.013.000FL	40.001.040.00	L G	488.– 528.–
15		Edelstahl, massiv Acciaio inox, massiccio	10.231.013.700FL	40.001.042.00	L G	816.– 882.–

* Mit Metallschlauch / Con flessibile in metallo

KWC

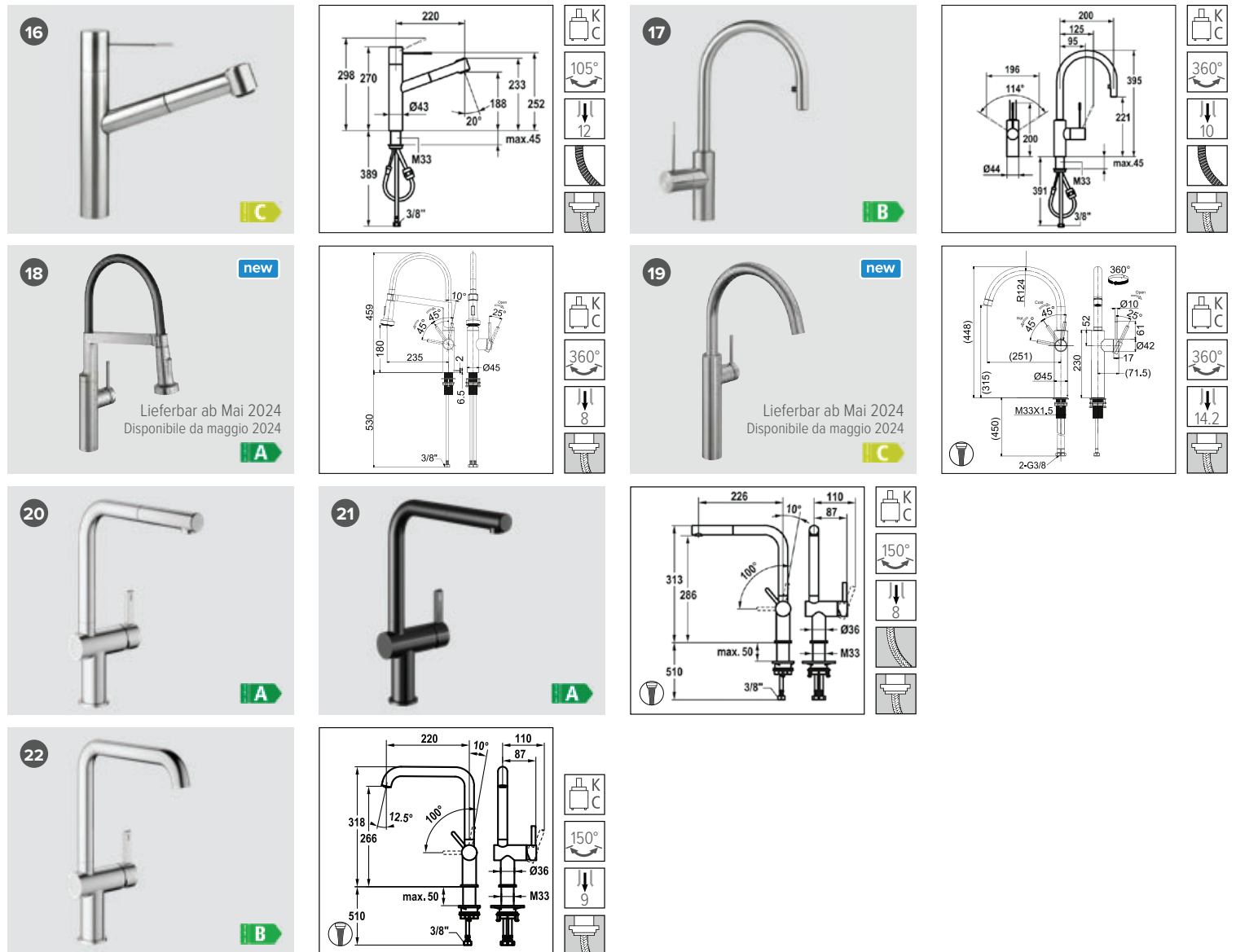

i Passende Dispenser und Zugknöpfe in allen Oberflächen auf den Seiten 353–360.
Dispenser e pomoli abbinabili a tutte le superfici alle pagine 353–360.

Preis CHF/Prezzo in CHF

Name	Modell	Version / Oberfläche	KWC-Nr.	Artikel-Nr.	Exkl. MWST	Inkl. MWST
Nome	Modello	Versione / Superficie	N. di KWC	N. di articolo	IVA esclusa	IVA inclusa
16	Ono	Auszugsbrause Doccia estraibile	* Top lever / Edelstahl, massiv Top lever / Acciaio inox, massiccio	10.151.033.700FL	40.000.942.00 L	C 944.– 1020.–
17	Ono*	Auszugperlator Gland aérateur escamotable	* Side lever / Edelstahl, massiv Side lever / Acciaio inox, massiccio	10.151.102.700FL	40.000.944.00 L	C 934.– 1010.–
18	Bistro E	Profibrause Douchette professionnelle	Edelstahl, massiv Acciaio inox, massiccio	10.581.433.700FL	40.002.732.00 L	C 616.– 666.–
19	Bistro E	Schwenkauslauf Braccio girevole	Edelstahl, massiv Acciaio inox, massiccio	10.581.013.700FL	40.002.731.00 L	C 429.– 464.–
20	Bevo	Zugauslauf Boccaglio estraibile	Side lever / Edelstahl, massiv Side lever / Acciaio inox, massiccio	10.531.103.700FL	40.002.512.00 L	C 410.– 443.–
21		Side lever / PVD-Beschichtung, Inox Black Side lever / Rivestimento a PVD con Inox Black	10.531.103.751FL	40.002.513.00 L	C 574.– 620.–	
22	Bevo	Schwenkauslauf Braccio girevole	Side lever / Edelstahl, massiv Side lever / Acciaio inox, massiccio	10.531.012.700FL	40.002.514.00 L	C 311.– 336.–

* Griffhebel rechts oder links / Leva a destra o a sinistra * Mit Metallschlauch / Con flessibile in metallo ☆ Mit Nylonschlauch / Con flessibile in nylon Ⓢ Mit Laminarstrahl / Con getto laminare

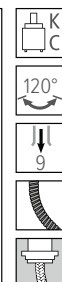
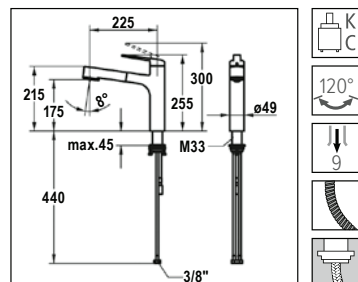
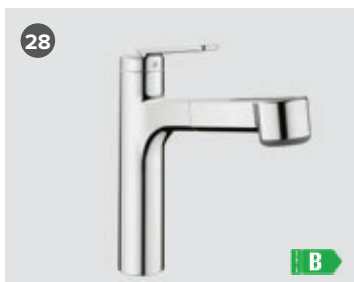
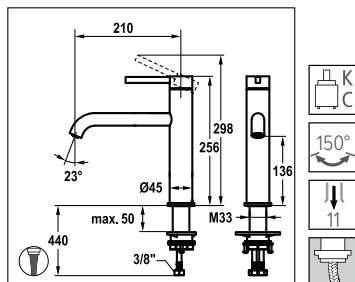
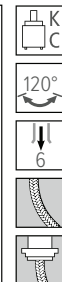
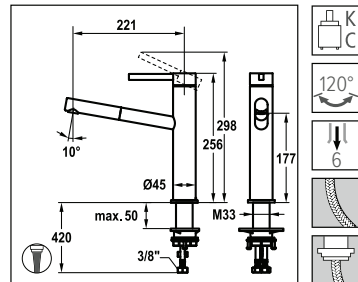
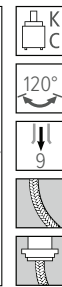
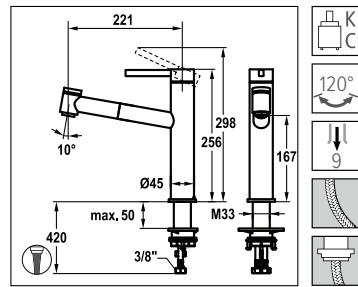
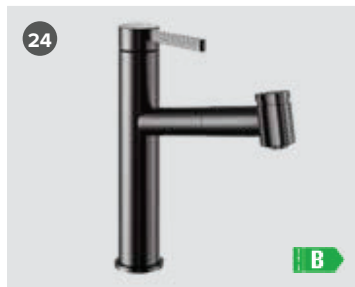

Kartusche keramisch
Cartuccia a dischi ceramic

Schwenkbereich
Raggio d'azione

Durchfluss l/min. (3 bar)
Scarico l/min. (3 bar)

Auslauf mit Nylonschlauch
Doccia con flessibile in nylon

Auslauf mit Metallschlauch
Doccia con flessibile in metallo

Flexible Anschlussschläuche
Raccordi flessibili

Mit Laminarstrahl
Con getto laminare

Preis CHF / Prezzo in CHF

Name Nome	Modell Modello	Version / Oberfläche Versione / Superficie	KWC-Nr. N. di KWC	Artikel-Nr. N. di articolo	Exkl. MWST IVA esclusa	Inkl. MWST IVA inclusa
23 Bevo	Auszugsbrause Doccia estraibile	Top lever / Edelstahl, massiv Top lever / Acciaio inox, massiccio	10.531.032.700FL	40.002.506.00	L C	398.– / 430.–
		Top lever / PVD-Beschichtung, Inox Black Top lever / Rivestimento a PVD con Inox Black	10.531.032.751FL	40.002.507.00	L C	557.– / 602.–
25 Bevo	Zugauslauf Boccaglio estraibile	Top lever / Edelstahl, massiv Top lever / Acciaio inox, massiccio	10.531.112.700FL	40.002.508.00	L C	371.– / 401.–
		Top lever / PVD-Beschichtung, Inox Black Top lever / Rivestimento a PVD con Inox Black	10.531.112.751FL	40.002.509.00	L C	519.– / 561.–
27 Bevo	Schwenkauslauf Braccio girevole	Top lever / Edelstahl, massiv Top lever / Acciaio inox, massiccio	10.531.022.700FL	40.002.510.00	L C	285.– / 308.–
28 Domo	Auszugsbrause Doccia estraibile	Chrom Cromato	10.661.033.000FL	40.002.138.00	L C	441.– / 477.–
		Edelstahl, massiv Acciaio inox, massiccio	10.701.033.700FL	40.002.221.00	L C	645.– / 697.–

* Mit Metallschlauch / Con flessibile in metallo ☆ Mit Nylonschlauch / Con flessibile in nylon Mit Laminarstrahl / Con getto laminare

KWC

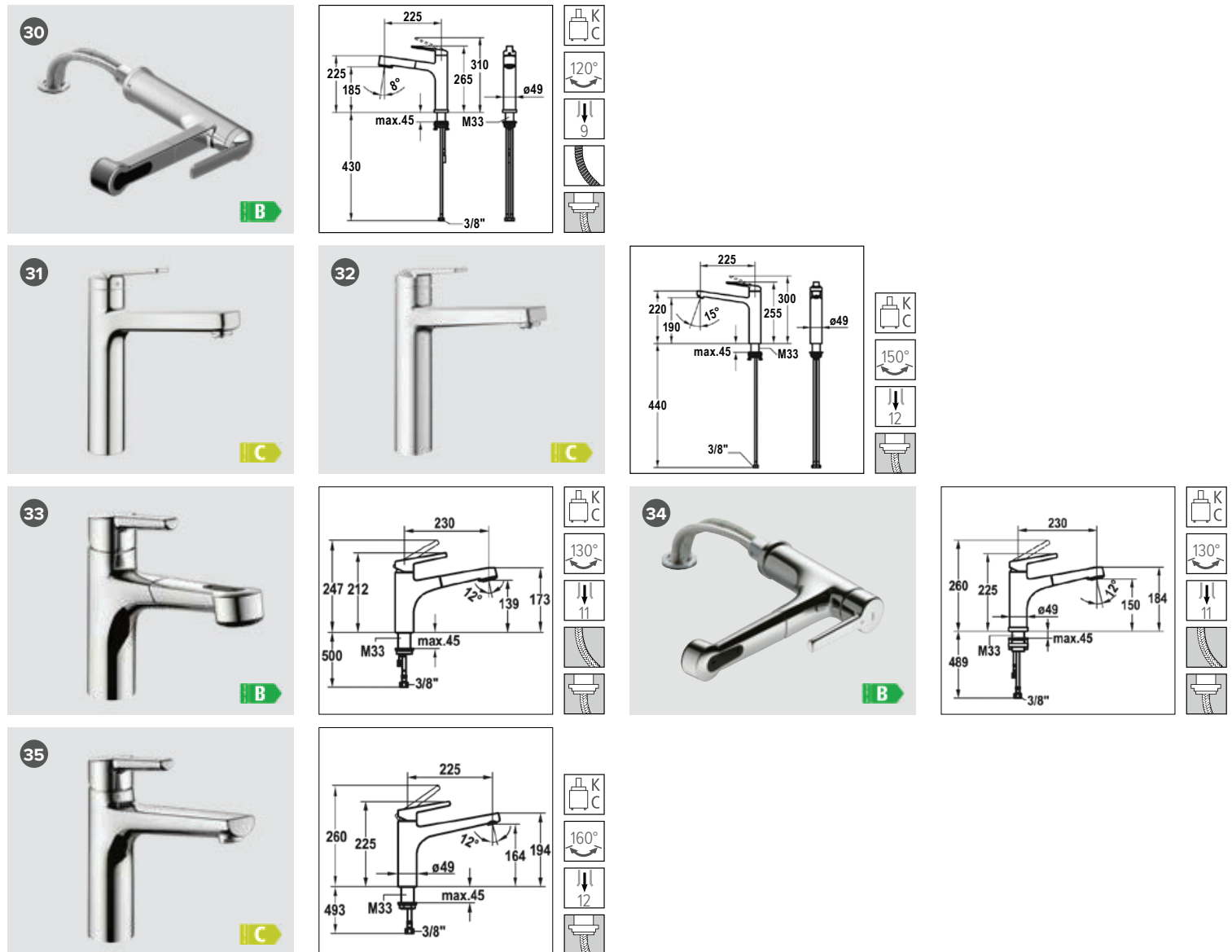

i Passende Dispenser und Zugknöpfe
in allen Oberflächen auf den
Seiten 353–360.
Dispenser e pomoli abbinabili a tutte le superfici
alle pagine 353–360.

Preis CHF/Prezzo in CHF

Name Nome	Modell Modello	Version/Oberfläche Versione/Superficie	KWC-Nr. N. di KWC	Artikel-Nr. N. di articolo	Exkl. MWST IVA esclusa	Inkl. MWST IVA inclusa
30 Domo Unterfenster Armatur Rubinetto sottofinestra	Auszugsbrause Höhe 60 mm* Doccia estraibile Altezza 60 mm*	* Chrom Cromato	10.661.053.000FL	40.002.139.00 L C	594.–	642.–
31 Domo	Schwenkauslauf Braccio girevole	Chrom Cromato	10.661.023.000FL	40.002.137.00 L C	312.–	337.–
32		Edelstahl, massiv Acciaio inox, massiccio	10.701.023.700FL	40.002.222.00 L C	457.–	494.–
33 Suno	Auszugsbrause Doccia estraibile	☆ Chrom Cromato	10.171.033.000FL	40.001.993.00 L C	413.–	446.–
34 Suno Unterfenster-Armatur Rubinetto sottofinestra	Auszugsbrause Höhe 55 mm* Doccia estraibile Altezza 55 mm*	☆ Chrom Cromato	10.171.053.000FL	40.001.994.00 L C	557.–	602.–
35 Suno	Schwenkauslauf Braccio girevole	Chrom Cromato	10.171.023.000FL	40.001.995.00 L C	295.–	319.–

* Verbleibende Höhe in gekipptem Zustand / Altezza in posizione basculante * Mit Metallschlauch / Con flessibile in metallo ☆ Mit Nylonschlauch / Con flessibile in nylon



Kartusche keramisch
Cartuccia a dischi ceramic

Schwenkbereich
Raggio d'azione

Durchfluss l/min. (3 bar)
Scarico l/min. (3 bar)

Auslauf mit Nylonschlauch
Doccia con flessibile in nylon

Auslauf mit Metallschlauch
Doccia con flessibile in metallo

Flexible Anschlusschläuche
Raccordi flessibili

Mit Laminarstrahl
Con getto laminare

Preis CHF / Prezzo in CHF

Name Nome	Modell Modello	Version / Oberfläche Versione / Superficie	KWC-Nr. N. di KWC	Artikel-Nr. N. di articolo	Exkl. MWST IVA esclusa	Inkl. MWST IVA inclusa		
36	Ava	Chrom Cromato	10.461.032.000FL	40.002.516.00	L C	401.–	433.–	
37		* Edelstahl-Finish Acciaio inox-finish	10.461.032.177FL	40.002.723.00	L C	541.–	585.–	
38		Pulverbeschichtung schwarz, matt Rivestimento con polvere nero, opaco	10.461.032.176FL	40.002.724.00	L C	541.–	585.–	
39	Ava	Chrom Cromato	10.461.022.000FL	40.002.517.00	L C	287.–	310.–	
40		* Edelstahl-Finish Acciaio inox-finish	10.461.022.177FL	40.002.721.00	L C	387.–	418.–	
41		Pulverbeschichtung schwarz, matt Rivestimento con polvere nero, opaco	10.461.022.176FL	40.002.722.00	L C	387.–	418.–	
42	Wamas	Auszugsbrause Doccia estraibile	☆ Chrom Cromato	10.471.032.000FL	40.002.730.00	L C	351.–	379.–
43	Wamas	Schwenkauslauf Braccio girevole	Chrom Cromato	10.471.022.000FL	40.002.729.00	L C	258.–	279.–

* Mit Metallschlauch / Con flessibile in metallo ☆ Mit Nylonschlauch / Con flessibile in nylon

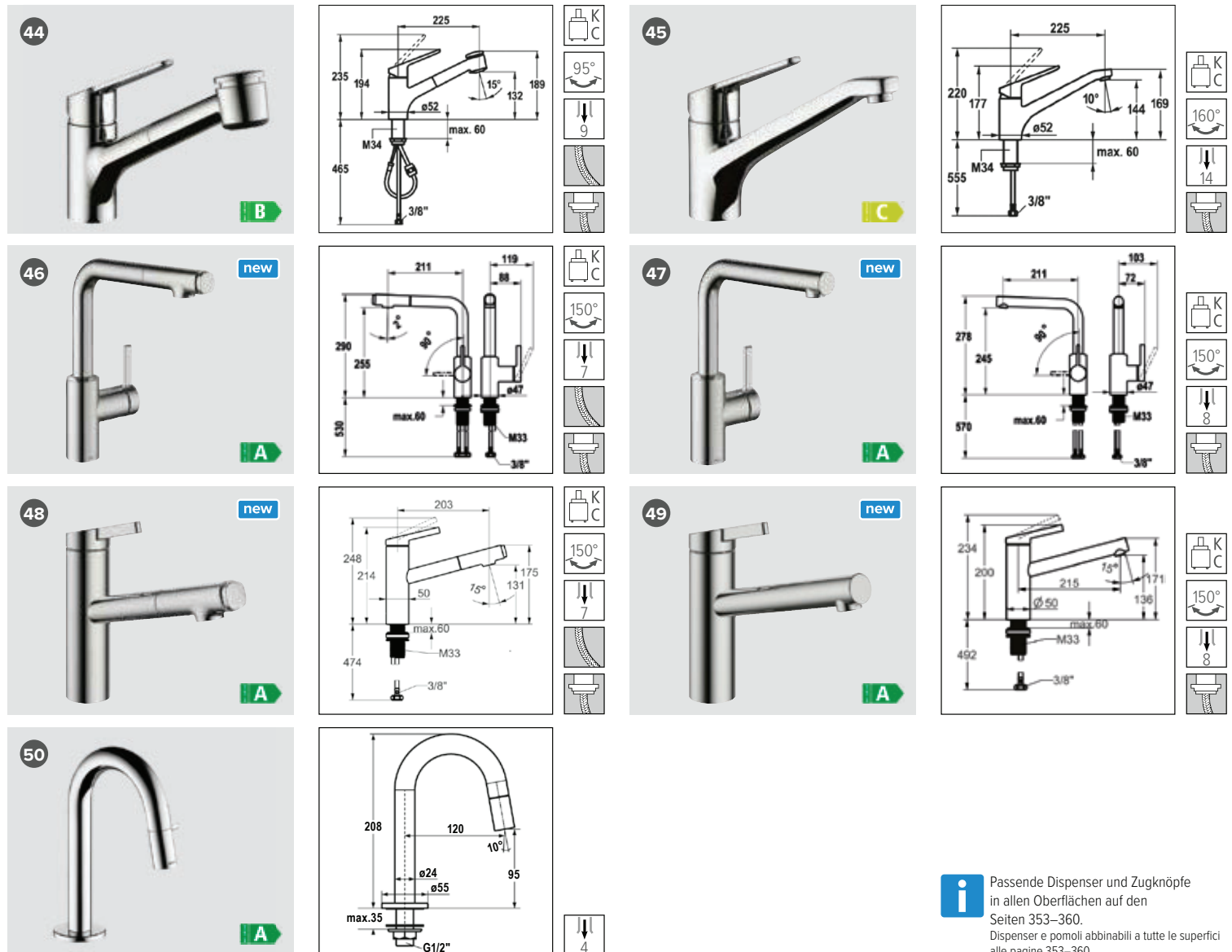
KWC

i Passende Dispenser und Zugknöpfe in allen Oberflächen auf den Seiten 353–360.
Dispenser e pomoli abbinabili a tutte le superfici alle pagine 353–360.

Kartusche keramisch
Cartuccia a dischi ceramic

Auslauf mit Metallschlauch
Doccia con flessibile in metallo

Schwenkbereich
Raggio d'azione

Flexible Anschlusschläuche
Raccordi flessibili

Durchfluss l/min. (3 bar)
Scarico l/min. (3 bar)

Mit Laminarstrahl
Con getto laminare

Auslauf mit Nylonschlauch
Doccia con flessibile in nylon

Preis CHF/Prezzo in CHF

Name Nome	Modell Modello	Version/Oberfläche Versione/Superficie	KWC-Nr. N. di KWC	Artikel-Nr. N. di articolo	Exkl. MWST IVA esclusa	Inkl. MWST IVA inclusa
44 Isla	Auszugsbrause Doccia estraibile	☆ Chrom Cromato	10.371.033.000FL	40.001.991.00 L C	282.–	305.–
45 Isla	Schwenkauslauf Braccio girevole	Chrom Cromato	10.371.023.000FL	40.001.992.00 L C	187.–	202.–
46 Fit	Auszugsbrause Doccia estraibile	☆ Side lever / Chrom Side lever / Cromato	10.541.002.000FL	40.002.728.00 L C	231.–	250.–
47 Fit	Schwenkauslauf Braccio girevole	Side lever / Chrom Side lever / Cromato	10.541.012.000FL	40.002.727.00 L C	165.–	178.–
48 Fit	Auszugsbrause Doccia estraibile	☆ Top lever / Chrom Top lever / Cromato	10.541.032.000FL	40.002.726.00 L C	210.–	227.–
49 Fit	Schwenkauslauf Braccio girevole	Top lever / Chrom Top lever / Cromato	10.541.022.000FL	40.002.725.00 L C	150.–	162.–
50 Kaltwasser-standventil Rubinetto a pressione per acqua fredda	Festauslauf (nicht schwenkbar) Erogatore fisso (non orientabile)	Chrom Cromato	25.001.010.000	40.002.141.00 L C	159.–	172.–



Exklusiv bei Suter / Un'esclusiva di Suter



Preis CHF/Prezzo in CHF

	Name Nome	Modell Modello	Version / Oberfläche Versione / Superficie	Gessi-Nr. N. di Gessi	Artikel-Nr. N. di articolo		Exkl. MWST IVA esclusa	Inkl. MWST IVA inclusa
1	Segno	Profibrause Doccia professionale	Chrom	60664.031	40.002.754.00	L H	942.-	1018.-
2			Edelstahl-Finish	60664.149	40.002.755.00	L H	1062.-	1148.-
3			Pulverbeschichtung schwarz, matt	60664.299	40.002.756.00	L H	1062.-	1148.-
4	Segno	Zugauslauf Boccaglio estraibile	Side lever C / Chrom	60672.031	40.002.751.00	L H	761.-	823.-
5			Side lever C / Edelstahl-Finish	60672.149	40.002.752.00	L H	897.-	970.-
6			Side lever C / Pulverbeschichtung schwarz, matt	60672.299	40.002.753.00	L H	897.-	970.-
7	Segno	Schwenkauslauf Braccio girevole	Side lever C / Chrom	60670.031	40.002.748.00	L H	621.-	671.-
8			Side lever C / Edelstahl-Finish	60670.149	40.002.749.00	L H	746.-	806.-
9	Segno	Zugauslauf Boccaglio estraibile	Side lever U / Chrom	60652.031	40.002.745.00	L H	746.-	806.-
10			Side lever U / Edelstahl-Finish	60652.149	40.002.746.00	L H	887.-	959.-
11			Side lever U / Pulverbeschichtung schwarz, matt	60652.299	40.002.747.00	L H	887.-	959.-

☆ Mit Nylonschlauch / Con flessibile in nylon

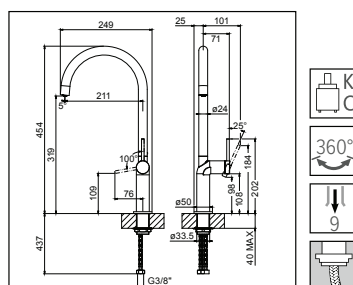
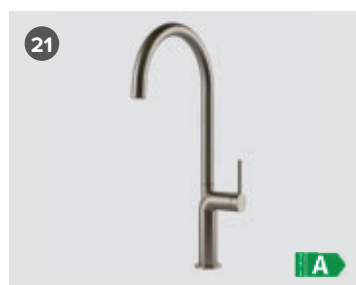
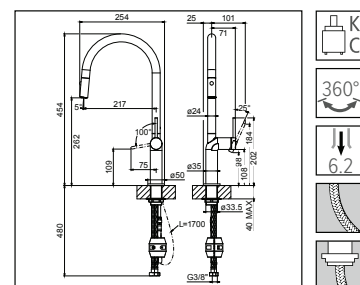
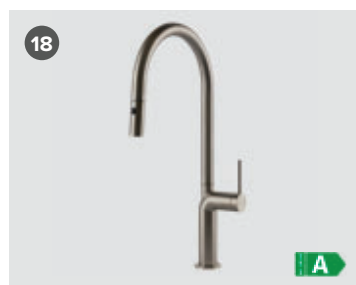
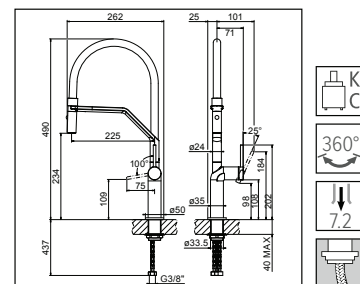
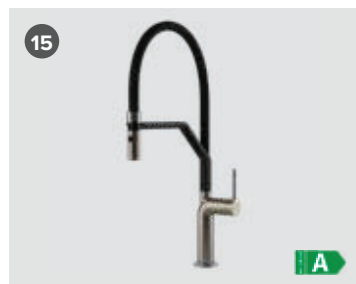
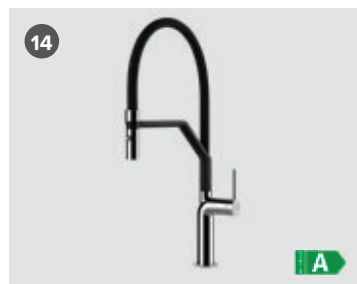
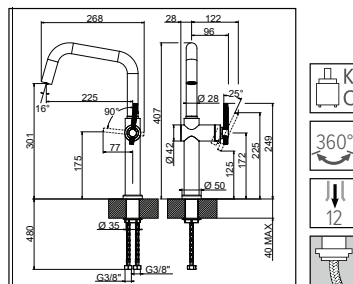
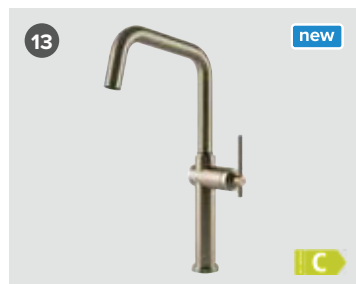
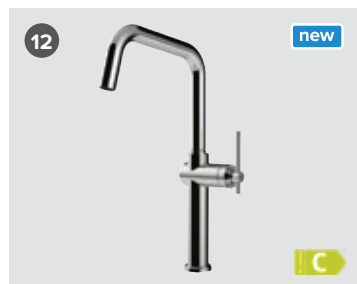

i Passende Dispenser und Zugknöpfe in allen Oberflächen auf den Seiten 353–360.
Dispenser e pomoli abbinabili a tutte le superfici alle pagine 353–360.

Preis CHF/Prezzo in CHF

	Name Nome	Modell Modello	Version/Oberfläche Versione/Superficie	Gessi-Nr. N. di Gessi	Artikel-Nr. N. di articolo	Exkl. MWST IVA esclusa	Inkl. MWST IVA inclusa	
12	Segno	Schwenkauslauf Braccio girevole	Side lever U/Chrom	60650.031	40.002.742.00	L H	598.–	
			Side lever U/Cromato				646.–	
13			Side lever U/Edelstahl-Finish	60650.149	40.002.743.00	L H	721.–	
			Side lever U/Acciaio inox-finish				779.–	
1	Stelo	Profibrause Doccia professionale	Chrom	60315.031	40.002.119.00	L H	720.–	
2				Edelstahl-Finish	60315.149	40.002.120.00	L H	822.–
				Acciaio inox-finish				889.–
3			Pulverbeschichtung schwarz, matt Rivestimento con polvere nero, opaco	60315.299	40.002.121.00	L H	822.–	
4	Stelo	Auszugsbrause Doccia estraibile	Side lever C/Chrom	60303.031	40.002.106.00	L H	540.–	
5				Side lever C/Cromato				584.–
				Side lever C/Edelstahl-Finish	60303.149	40.002.107.00	L H	678.–
6				Side lever C/Acciaio inox-finish				733.–
			Side lever C/Pulverbeschichtung schwarz, matt Side lever C/Rivestimento con polvere nero, opaco	60303.299	40.002.108.00	L H	678.–	
7	Stelo	Schwenkauslauf Braccio girevole	Side lever C/Chrom	60301.031	40.002.104.00	L H	395.–	
8				Side lever C/Cromato				427.–
			Side lever C/Edelstahl-Finish	60301.149	40.002.105.00	L H	502.–	
			Side lever C/Acciaio inox-finish				543.–	

☆ Mit Nylonschlauch / Con flessibile in nylon



Exklusiv bei Suter / Un'esclusiva di Suter

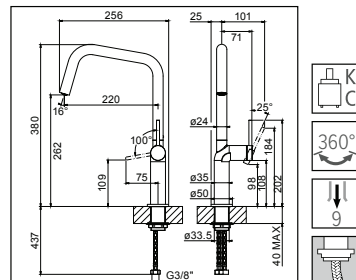
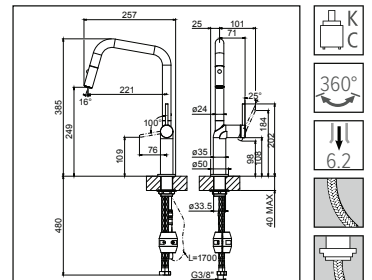
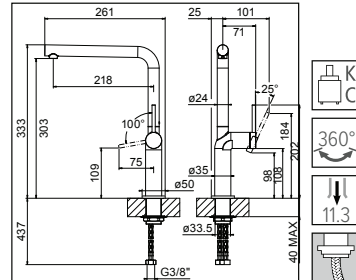
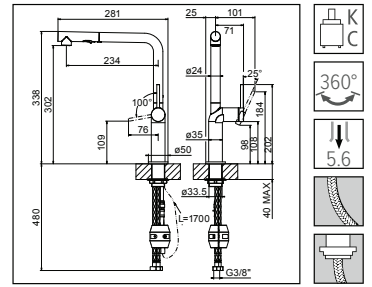

Kartusche keramisch
Cartuccia a dischi ceramic

Schwenkbereich
Raggio d'azione

Durchfluss l/min. (3 bar)
Scarico l/min. (3 bar)

Auslauf mit Nylonschlauch
Doccia con flessibile in nylon

Auslauf mit Metallschlauch
Doccia con flessibile in metallo

Flexible Anschlussschläuche
Raccordi flessibili

Mit Laminarstrahl
Con getto laminare

Preis CHF / Prezzo in CHF

	Name Nome	Modell Modello	Version / Oberfläche Versione / Superficie	Gessi-Nr. N. di Gessi	Artikel-Nr. N. di articolo	Exkl. MWST IVA esclusa	Inkl. MWST IVA inclusa	
22	Stelo	Auszugsbrause Doccia estraibile	Side lever L / Chrom Side lever L / Cromato	60311.031	40.002.116.00	L H	489.–	529.–
23			Side lever L / Edelstahl-Finish Side lever L / Acciaio inox-finish	60311.149	40.002.117.00	L H	621.–	671.–
24			Side lever L / Pulverbeschichtung schwarz, matt Side lever L / Rivestimento con polvere nero, opaco	60311.299	40.002.118.00	L H	621.–	671.–
25	Stelo	Schwenkauslauf Braccio girevole	Side lever L / Chrom Side lever L / Cromato	60309.031	40.002.114.00	L H	381.–	412.–
26			Side lever L / Edelstahl-Finish Side lever L / Acciaio inox-finish	60309.149	40.002.115.00	L H	502.–	543.–
27	Stelo	Auszugsbrause Doccia estraibile	Side lever U / Chrom Side lever U / Cromato	60307.031	40.002.111.00	L H	540.–	584.–
28			Side lever U / Edelstahl-Finish Side lever U / Acciaio inox-finish	60307.149	40.002.112.00	L H	678.–	733.–
29			Side lever U / Pulverbeschichtung schwarz, matt Side lever U / Rivestimento con polvere nero, opaco	60307.299	40.002.113.00	L H	678.–	733.–
30	Stelo	Schwenkauslauf Braccio girevole	Side lever U / Chrom Side lever U / Cromato	60305.031	40.002.109.00	L H	381.–	412.–
31			Side lever U / Edelstahl-Finish Side lever U / Acciaio inox-finish	60305.149	40.002.110.00	L H	502.–	543.–

☆ Mit Nylonschlauch / Con flessibile in nylon

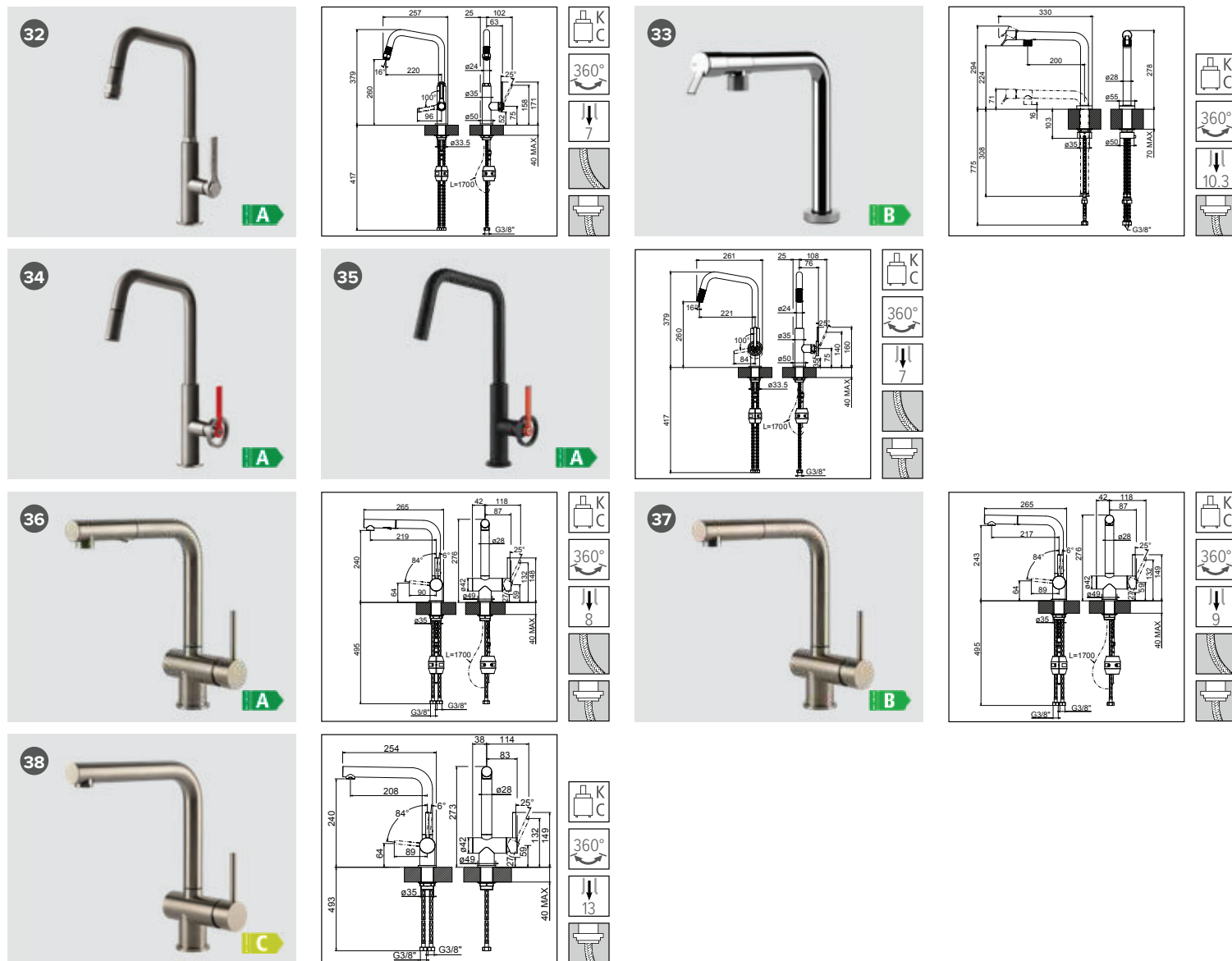

i Passende Dispenser und Zugknöpfe in allen Oberflächen auf den Seiten 353–360.
Dispenser e pomoli abbinabili a tutte le superfici alle pagine 353–360.

Preis CHF / Prezzo in CHF

Name Nome	Modell Modello	Version / Oberfläche Versione / Superficie	Gessi-Nr. N. di Gessi	Artikel-Nr. N. di articolo	Exkl. MWST IVA esclusa	Inkl. MWST IVA inclusa
32 Officine Gessi	Zugauslauf Boccaglio estraibile	Edelstahl-Finish Acciaio inox-finish	60053.149	40.002.130.00 L H	775.–	838.–
33 SU & GIU	Unterfenster-Armatur Rubinetto sottofinestra	Schwenkauslauf, absenkbar Höhe 71 mm* Braccio girevole, abbassabile Altezza 71 mm*	60071.031	40.002.131.00 L H	786.–	850.–
34 Officine V	Zugauslauf Boccaglio estraibile	Edelstahl-Finish Acciaio inox-finish	60203.149	40.002.125.00 L H	666.–	720.–
35		Pulverbeschichtung schwarz, matt Rivestimento con polvere nero, opaco	60203.299	40.002.126.00 L H	666.–	720.–
36 Soletto	Auszugsbrause Doccia estraibile	Edelstahl, massiv Acciaio inox, massiccio	60600.239	40.002.547.00 L H	568.–	614.–
37 Soletto	Zugauslauf Boccaglio estraibile	Edelstahl, massiv Acciaio inox, massiccio	60598.239	40.002.548.00 L H	518.–	560.–
38 Soletto	Schwenkauslauf Braccio girevole	Edelstahl, massiv Acciaio inox, massiccio	60596.239	40.002.549.00 L H	478.–	517.–

* Verbleibende Höhe in abgelenktem Zustand / Altezza restante nella posizione abbassata

☆ Mit Nylonschlauch / Con flessibile in nylon



Exklusiv bei Suter / Un'esclusiva di Suter

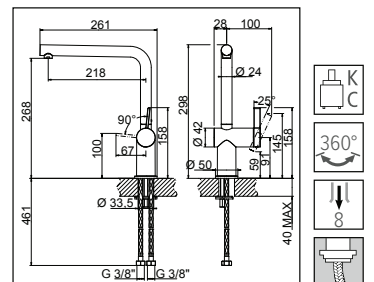
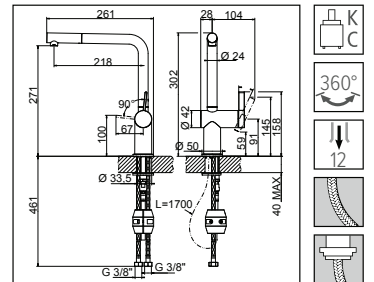
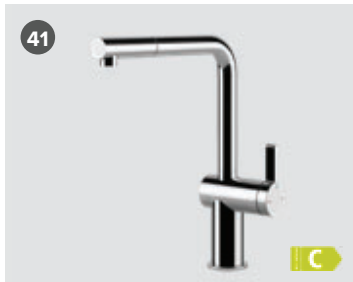
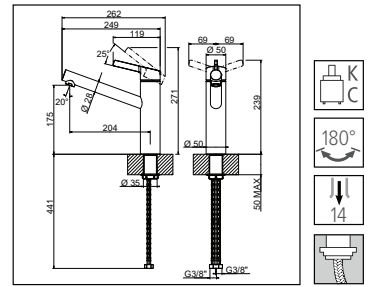
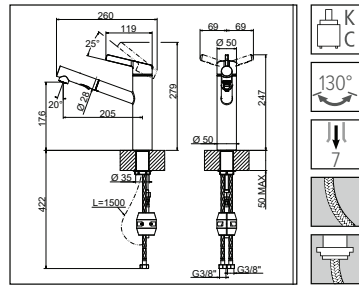

- Kartusche keramisch / Cartuccia a dischi ceramic
- Auslauf mit Metallschlauch / Doccia con flessibile in metallo

- Schwenkbereich / Raggio d'azione
- Flexible Anschlussschläuche / Raccordi flessibili

- Durchfluss l/min. (3 bar) / Scarico l/min. (3 bar)
- Mit Laminarstrahl / Con getto laminare

- Auslauf mit Nylonschlauch / Doccia con flessibile in nylon

Preis CHF / Prezzo in CHF

Name Nome	Modell Modello	Version / Oberfläche Versione / Superficie	Gessi-Nr. N. di Gessi	Artikel-Nr. N. di articolo	Exkl. MWST IVA esclusa	Inkl. MWST IVA inclusa
39 Lunis	Auszugsbrause Doccia estraibile	Edelstahl, massiv Acciaio inox, massiccio	60666.239	40.002.741.00	667.–	721.–
40 Lunis	Schwenkauslauf Braccio girevole	Edelstahl, massiv Acciaio inox, massiccio	60662.239	40.002.740.00	578.–	625.–
41	Zugauslauf Boccaglio estraibile	Chrom Cromato	60617.031	40.002.424.00	439.–	475.–
42 Divino*		Edelstahl-Finish Acciaio inox-finish	60617.149	40.002.425.00	529.–	572.–
43		Pulverbeschichtung schwarz, matt Rivestimento con polvere nero, opaco	60617.299	40.002.426.00	529.–	572.–
44	Schwenkauslauf Braccio girevole	Chrom Cromato	60615.031	40.002.421.00	356.–	385.–
45 Divino*		Edelstahl-Finish Acciaio inox-finish	60615.149	40.002.422.00	449.–	485.–
46		Pulverbeschichtung schwarz, matt Rivestimento con polvere nero, opaco	60615.299	40.002.423.00	449.–	485.–

☆ Mit Nylonschlauch / Con flessibile in nylon

*Modell ist mit Befestigungs-Set mit Befestigungsbügel (Hufeisen) ausgerüstet. Bei der Montage die mitgelieferte Verstärkungsplatte (Dreieck) verwenden.

*Il modello è dotato di set di fissaggio con staffa di fissaggio (a forma di ferro di cavallo). Utilizzare la piastra di rinforzo in dotazione (triangolo) per il montaggio.

LAUFEN Exklusiv bei Suter/Un'esclusiva di Suter

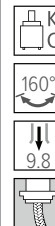
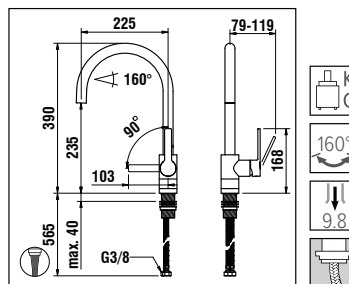
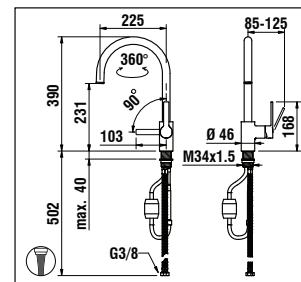
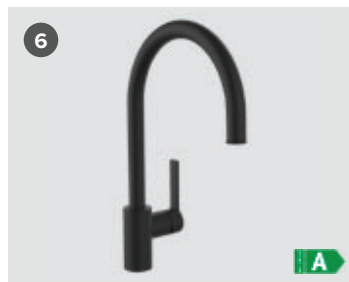
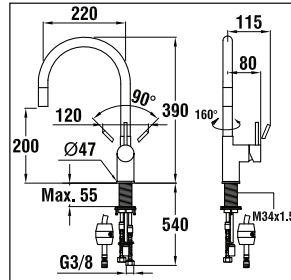
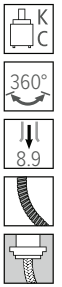
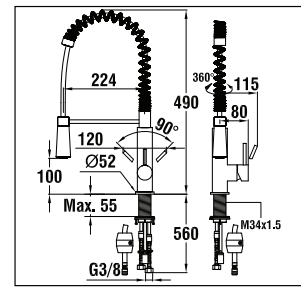
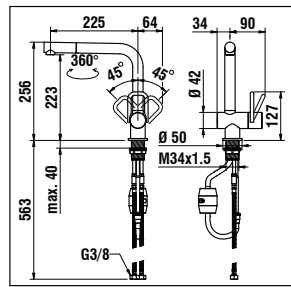
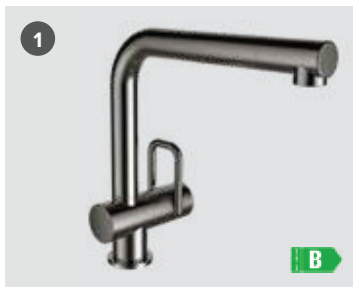

i Passende Dispenser und Zugknöpfe in allen Oberflächen auf den Seiten 353–360.
Dispenser e pomoli abbinabili a tutte le superfici alle pagine 353–360.

Preis CHF/Prezzo in CHF

	Name Nome	Modell Modello	Version / Oberfläche Versione / Superficie	Artikel-Nr. N. di articolo	Exkl. MWST IVA esclusa	Inkl. MWST IVA inclusa
1	Twin*	Zugauslauf Boccaglio estraibile	☆ PVD-Beschichtung, Graphit Rivestimento a PVD, grafite	40.001.270.00 L	C 1052.–	1137.–
2	Sento	Pendelauslauf Bocca oscillante	* Side lever /Edelstahl, massiv Side lever /Acciaio inox, massiccio	40.001.299.00 L	G 965.–	1043.–
3	Sento	Zugauslauf Boccaglio estraibile	☆ Side lever C /Edelstahl, massiv Side lever C /Acciaio inox, massiccio	40.001.297.00 L LA	G 761.–	823.–
4			Side lever C /Chrom Side lever C /Cromato	40.002.225.00 L	G 452.–	489.–
5	Epic	Zugauslauf Boccaglio estraibile	Ⓢ ☆ Side lever C /Edelstahl, massiv Side lever C /Acciaio inox, massiccio	40.002.226.00 L	G 845.–	913.–
6			Side lever C /PVD-Beschichtung, Inox Black Side lever C, rivestimento a PVD, Inox Black	40.002.505.00 L	G 953.–	1030.–
7			Side lever C /Chrom Side lever C /Cromato	40.002.227.00 L	G 411.–	444.–
8	Epic	Schwenkauslauf Braccio girevole	Ⓢ ☆ Side lever C /Edelstahl, massiv Side lever C /Acciaio inox, massiccio	40.002.228.00 L	G 802.–	867.–

LAUFEN Exklusiv bei Suter/Un'esclusiva di Suter

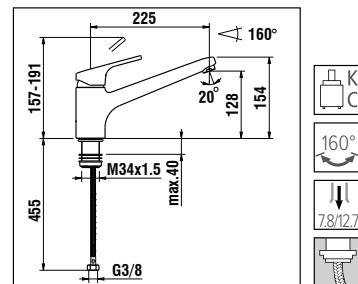
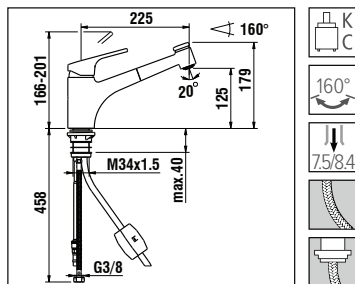
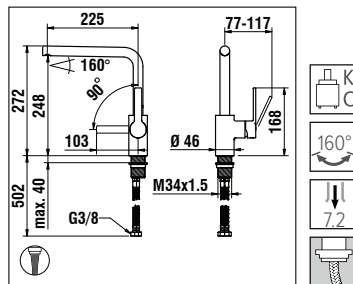
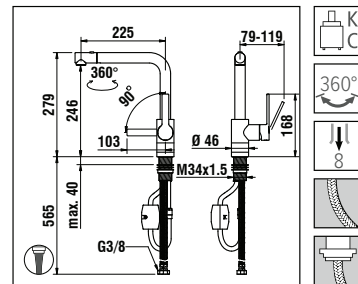

Kartusche keramisch
Cartuccia a dischi ceramic

Schwenkbereich
Raggio d'azione

Durchfluss l/min. (3 bar)
Scarico l/min. (3 bar)

Auslauf mit Nylonschlauch
Doccia con flessibile in nylon

Auslauf mit Metallschlauch
Doccia con flessibile in metallo

Flexible Anschlussschläuche
Raccordi flessibili

Mit Laminarstrahl
Con getto laminare

Preis CHF/Prezzo in CHF

Name Nome	Modell Modello	Version/Oberfläche Versione/Superficie	Artikel-Nr. N. di articolo	Exkl. MWST IVA esclusa	Inkl. MWST IVA inclusa
9	Auszugsbrause Doccia estraibile	Chrom Cromato	40.001.655.00 G	533.–	576.–
10		Edelstahl, massiv Acciaio inox, massiccio	40.001.729.00 G	846.–	915.–
11		PVD-Beschichtung, Inox Black Rivestimento a PVD, Inox Black	40.002.504.00 G	970.–	1049.–
12	Schwenkauslauf Braccio girevole	Chrom Cromato	40.001.656.00 G	428.–	463.–
13		Edelstahl, massiv Acciaio inox, massiccio	40.001.730.00 G	690.–	746.–
14	Auszugsbrause Doccia estraibile	Chrom Cromato	40.001.975.00 G	348.–	376.–
15	Schwenkauslauf Braccio girevole	Chrom Cromato	40.001.976.00 G	209.–	226.–

☆ Mit Nylonschlauch/Con flessibile in nylon Mit Laminarstrahl/Con getto laminare

LAUFEN

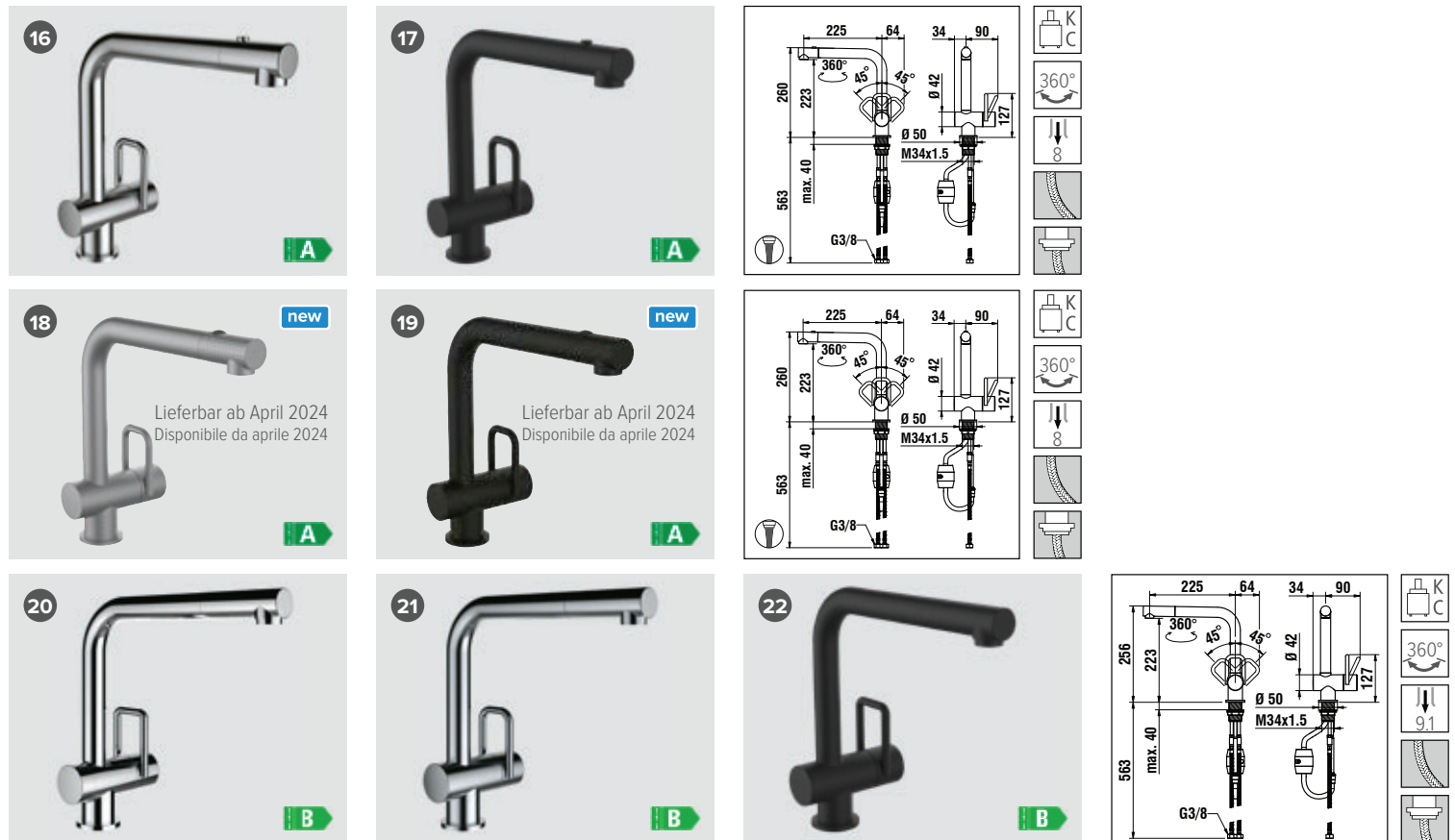

i Passende Dispenser und Zugknöpfe
in allen Oberflächen auf den
Seiten 353–360.
Dispenser e pomoli abbinabili a tutte le superfici
alle pagine 353–360.

Preis CHF/Prezzo in CHF

Name Nome	Modell Modello	Version / Oberfläche Versione / Superficie	Laufen-Nr. N. di Laufen	Artikel-Nr. N. di articolo	Exkl. MWST IVA esclusa	Inkl. MWST IVA inclusa	
16	Twin* Auszugsbrause Doccia estraibile	Edelstahl, massiv Acciaio inox, massiccio	HF989683441001	40.001.456.00	L C	853.– 922.–	
17		PVD-Beschichtung, Inox Black Rivestimento a PVD, Inox Black	HF989683448001	40.002.522.00	L C	1030.– 1113.–	
18	Twin S* Auszugsbrause Doccia estraibile	Edelstahl, massiv, mit Struktur Acciaio inox, massiccio, con struttura	HF989683A41001	40.002.737.00	L C	960.– 1038.–	
19		PVD-Beschichtung, Inox Black, mit Struktur Rivestimento a PVD, Inox Black, con struttura	HF989683A48001	40.002.738.00	L C	1130.– 1222.–	
	Twin* Zugauslauf Boccaglio estraibile	☆	HF989673100001	40.000.225.00	L C	524.– 566.–	
20	Twin* Unter- fenster-Armatur Rubinetto sottofinestra	Zugauslauf Höhe 155mm** Boccaglio estraibile Altezza 155mm**	☆	HF989673100001	40.000.262.00	L C	524.– 566.–
	Twin* Zugauslauf Boccaglio estraibile	☆	HF989693441001	40.001.104.00	L C	841.– 909.–	
21	Twin* Unter- fenster-Armatur Rubinetto sottofinestra	Zugauslauf Höhe 155mm** Boccaglio estraibile Altezza 155mm**	☆	HF989693441001	40.001.106.00	L C	841.– 909.–
22	Twin* Zugauslauf Boccaglio estraibile	PVD-Beschichtung, Inox Black Rivestimento a PVD, Inox Black	☆	HF989693448000	40.002.523.00	L C	1015.– 1097.–

* Griffhebel rechts oder links / Leva a destra o a sinistra ** Verbleibende Höhe in gekipptem Zustand / Altezza in posizione basculante ☆ Mit Nyllonschlauch / Con flessibile in nylon ① Mit Laminarstrahl / Con getto laminare

LAUFEN

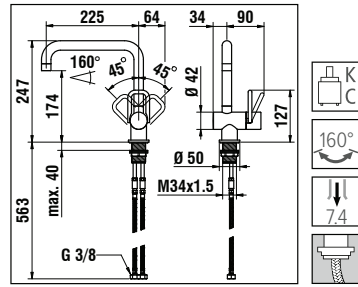

K C
 160°
 7.4

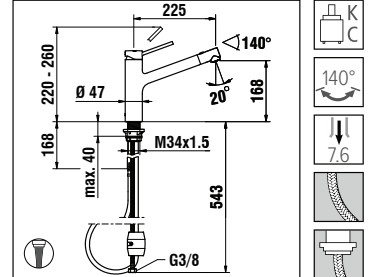

K C
 140°
 7.6

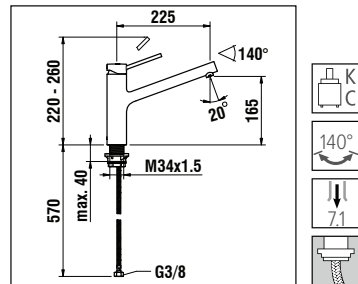

K C
 140°
 7.1

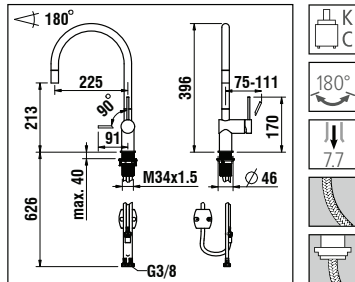

K C
 180°
 7.7

Lieferbar ab April 2024
Disponibile da aprile 2024

Kartusche keramisch
Cartuccia a dischi ceramic

Schwenkbereich
Raggio d'azione

Durchfluss l/min. (3 bar)
Scarico l/min. (3 bar)

Auslauf mit Nylonschlauch
Doccia con flessibile in nylon

Auslauf mit Metallschlauch
Doccia con flessibile in metallo

Flexible Anschlusschläuche
Raccordi flessibili

Mit Laminarstrahl
Con getto laminare

Preis CHF / Prezzo in CHF

Name Nome	Modell Modello	Version / Oberfläche Versione / Superficie	Laufen-Nr. N. di Laufen	Artikel-Nr. N. di articolo	Exkl. MWST IVA esclusa	Inkl. MWST IVA inclusa	
23	Twin*	Chrom Cromato	HF989532100001	40.000.223.00	L C	431.– 466.–	
24		Edelstahl, massiv Acciaio inox, massiccio	HF989552441001	40.001.339.00			
25	Twinplus	Chrom Cromato	HF905437100000	40.001.980.00	L C	496.– 536.–	
26		Auszugsbrause Doccia estraibile	Edelstahl, massiv Acciaio inox, massiccio	HF905437441000			40.002.142.00
27		PVD-Beschichtung, Inox Black Rivestimento a PVD, Inox Black	HF905437448000	40.002.525.00			
28	Twinplus	Chrom Cromato	HF905432100000	40.001.981.00	L C	411.– 444.–	
29		Edelstahl, massiv Acciaio inox, massiccio	HF905432441000	40.002.143.00			
30	Twinplus Slim	Zugauslauf Boccaglio estraibile	Edelstahl, massiv Acciaio inox, massiccio	HF505446441000	L C	400.– 432.–	

* Griffhebel rechts oder links / Leva a destra o a sinistra ☆ Mit Nylonschlauch / Con flessibile in nylon Ⓞ Mit Laminarstrahl / Con getto laminare

LAUFEN

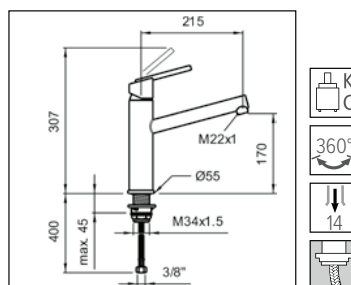
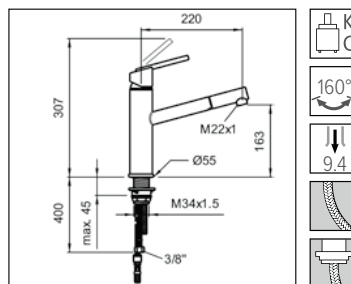
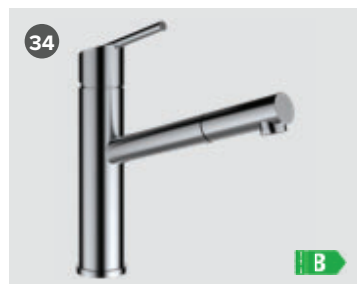
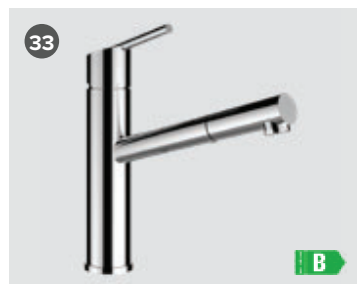
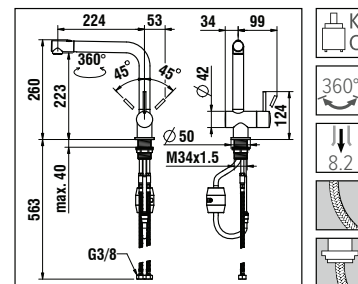
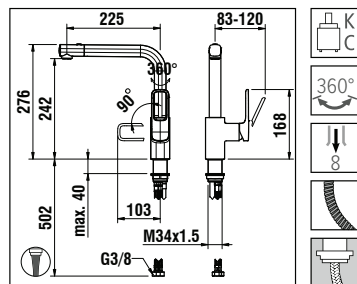

i Passende Dispenser und Zugknöpfe in allen Oberflächen auf den Seiten 353–360.
Dispenser e pomoli abbinabili a tutte le superfici alle pagine 353–360.

Preis CHF/Prezzo in CHF

Name Nome	Modell Modello	Version / Oberfläche Versione / Superficie	Laufen-Nr. N. di Laufen	Artikel-Nr. N. di articolo	Exkl. MWST IVA esclusa	Inkl. MWST IVA inclusa
31 Cityplus	Auszugsbrause Doccia estraibile	Ⓢ * Chrom Cromato	HF905335100000	40.001.731.00	552.–	597.–
32 Triathlon*	Auszugsbrause Doccia estraibile	☆ Edelstahl, massiv Acciaio inox, massiccio	HF502136441000	40.001.143.00	984.–	1064.–
33 Simichrom	Zugauslauf Boccaglio estraibile	☆ Chrom Cromato	HF503016100000	40.001.304.00	542.–	586.–
34 Siminox	Zugauslauf Boccaglio estraibile	☆ Edelstahl, massiv Acciaio inox, massiccio	HF503016441000	40.001.013.00	724.–	783.–
35 Simichrom	Schwenkauslauf Braccio girevole	Chrom Cromato	HF503017100000	40.001.303.00	507.–	548.–
36 Siminox	Schwenkauslauf Braccio girevole	Edelstahl, massiv Acciaio inox, massiccio	HF503017441000	40.001.120.00	692.–	748.–

* Griffhebel rechts oder links / Leva a destra o a sinistra * Mit Metallschlauch / Con flessibile in metallo ☆ Mit Nylonschlauch / Con flessibile in nylon Mit Laminarstrahl / Con getto laminare

LAUFEN

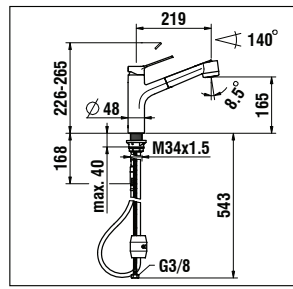

K
 C
 140°
 7.5

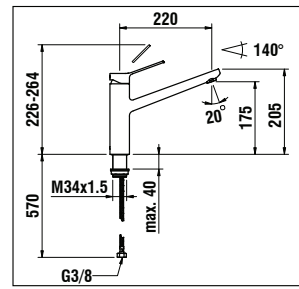

K
 C
 140°
 10.1

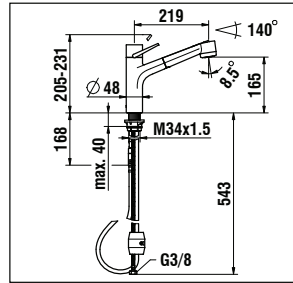

K
 C
 140°
 7.5

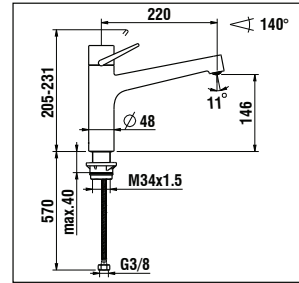

K
 C
 140°
 10.1

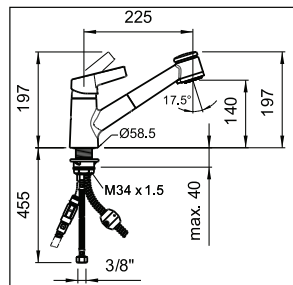

K
 C
 160°
 9.8

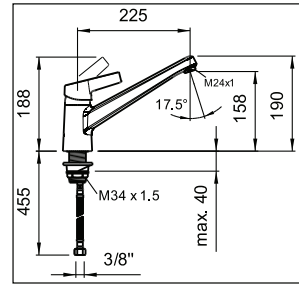

K
 C
 360°
 11.4

K
 C
 Kartusche keramisch
 Cartuccia a dischi ceramic

160°
 Schwenkbereich
 Raggio d'azione

12.1
 Durchfluss l/min. (3 bar)
 Scarico l/min. (3 bar)

Auslauf mit Nylonschlauch
 Doccia con flessibile in nylon

Auslauf mit Metallschlauch
 Doccia con flessibile in metallo

Flexible Anschlussschläuche
 Raccordi flessibili

Mit Laminarstrahl
 Con getto laminare

Preis CHF / Prezzo in CHF

Name Nome	Modell Modello	Version / Oberfläche Versione / Superficie	Laufen-Nr. N. di Laufen	Artikel-Nr. N. di articolo	Exkl. MWST IVA esclusa	Inkl. MWST IVA inclusa
37 Swisstap	Auszugsbrause Doccia estraibile	☆ Chrom Cromato	HF506135100000	40.002.518.00 C	468.-	506.-
38 Swisstap	Schwenkauslauf Braccio girevole	Chrom Cromato	HF506130100000	40.002.519.00 C	340.-	368.-
39 Class	Auszugsbrause Doccia estraibile	☆ Chrom Cromato	HF941035100000	40.002.520.00 C	477.-	516.-
40 Class	Schwenkauslauf Braccio girevole	Chrom Cromato	HF941030100000	40.002.521.00 C	346.-	374.-
41 Swap	Auszugsbrause Doccia estraibile	☆ Chrom Cromato	HF501809100000	40.000.946.00 C	410.-	443.-
42 Swap	Schwenkauslauf Braccio girevole	Chrom Cromato	HF501800100000	40.000.947.00 C	274.-	296.-

☆ Mit Nylonschlauch / Avec tuyau en nylon

hansgrohe

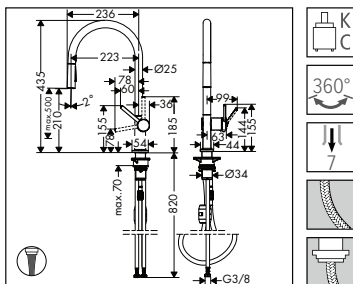
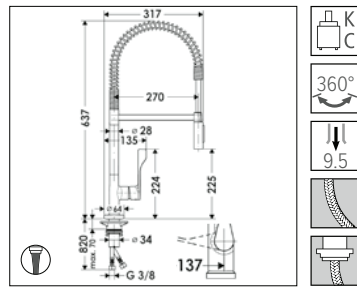
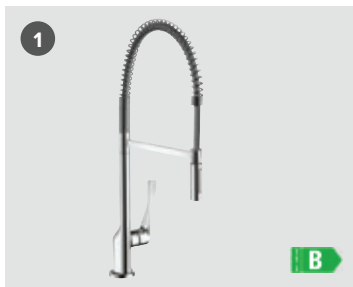

i Passende Dispenser und Zugknöpfe
in allen Oberflächen auf den
Seiten 353–360.
Dispenser e pomoli abbinabili a tutte le superfici
alle pagine 353–360.

Kartusche keramisch
Cartuccia a dischi ceramic

Auslauf mit Metallschlauch
Doccia con flessibile in metallo

Schwenkbereich
Raggio d'azione

Flexible Anschlussschläuche
Raccordi flessibili

Durchfluss l/min. (3 bar)
Scarico l/min. (3 bar)

Mit Laminarstrahl
Con getto laminare

Auslauf mit Nylonschlauch
Doccia con flessibile in nylon

Preis CHF / Prezzo in CHF

Name Nome	Modell Modello	Version / Oberfläche Versione / Superficie	Hansgrohe-Nr. N. di Hansgrohe	Artikel-Nr. N. di articolo	Exkl. MWST IVA esclusa	Inkl. MWST IVA inclusa
1 Axor Citterio	Profibrausengarnitur Doccia professionale	Chrom Cromato	39840000	40.001.441.00 C	897.–	970.–
2		Side lever C / Chrom Side lever C / Cromato	72800000	40.002.144.00 C	389.–	421.–
3		Side lever C / Edelstahl-Finish Side lever C / Acciaio inox-finish	72800800	40.002.145.00 C	505.–	546.–
4 Talis M54	Auszugsbrause Doccia estraibile	Side lever C / PVD-Beschichtung, Graphit Side lever C / Rivestimento a PVD, grafite	72800340	40.002.543.00 C	544.–	588.–
5		Side lever C / Nasslackierung schwarz, seidenglanz Side lever C / Laccato all'acqua nero, satinato lucido	72800670	40.002.146.00 C	505.–	546.–

☆ Mit Nylonschlauch / Con flessibile in nylon Mit Laminarstrahl / Con getto laminare

hansgrohe

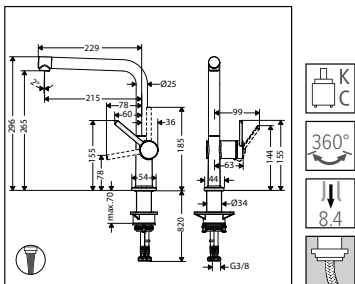
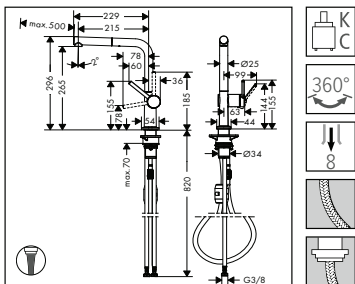

Preis CHF/Prezzo in CHF

Name Nome	Modell Modello	Version / Oberfläche Versione / Superficie	Hansgrohe-Nr. N. di Hansgrohe	Artikel-Nr. N. di articolo	Exkl. MWST IVA esclusa	Inkl. MWST IVA inclusa
6	Talis M54 Zugauslauf Boccaglio estraibile	Side lever L / Chrom	72808000	40.002.147.00	L C	265.–
7		Side lever L / Cromato				
8		Side lever L / Edelstahl-Finish				
9		Side lever L / Acciaio inox-finish				
10	Talis M54 Schwenkauslauf Braccio girevole	Side lever L / PVD-Beschichtung, Graphit	72808340	40.002.544.00	L C	372.–
11		Side lever L / Rivestimento a PVD, grafite				
12		Side lever L / Nasslackierung schwarz, seidenglanz				
13		Side lever L / Laccato all'acqua nero, satinato lucido				
13		Side lever L / Laccato all'acqua nero, satinato lucido				
10	Talis M54 Schwenkauslauf Braccio girevole	Side lever L / Chrom	72840000	40.002.150.00	L C	227.–
11		Side lever L / Cromato				
12		Side lever L / Edelstahl-Finish				
13		Side lever L / Acciaio inox-finish				
13		Side lever L / PVD-Beschichtung, Graphit				
13	Talis M54 Schwenkauslauf Braccio girevole	Side lever L / Rivestimento a PVD, grafite	72840340	40.002.545.00	L C	318.–
12		Side lever L / Nasslackierung schwarz, seidenglanz				
13		Side lever L / Laccato all'acqua nero, satinato lucido				
13		Side lever L / Laccato all'acqua nero, satinato lucido				
13		Side lever L / Laccato all'acqua nero, satinato lucido				

☆ Mit Nylonschlauch / Con flessibile in nylon Ⓢ Mit Laminarstrahl / Con getto laminare

hansgrohe

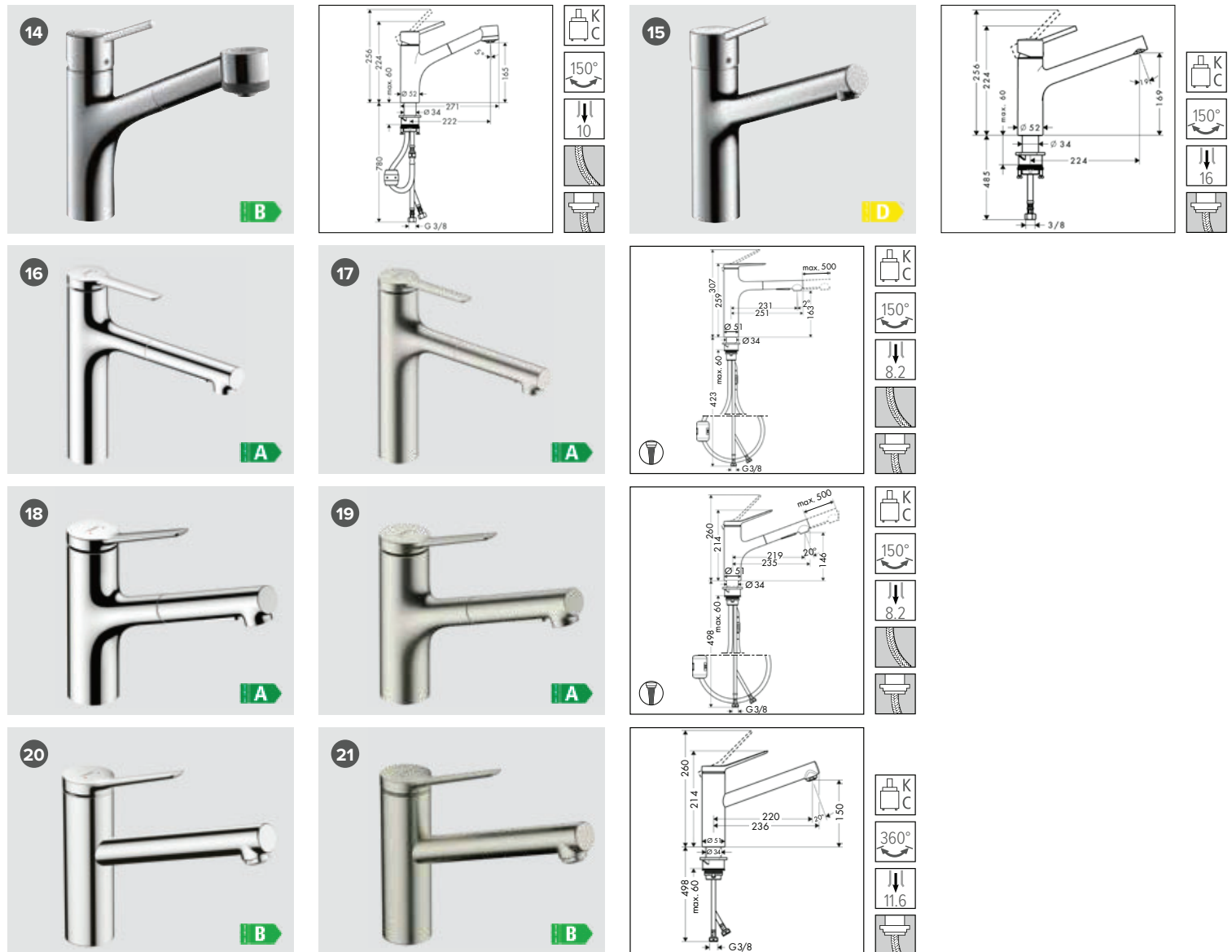

i Passende Dispenser und Zugknöpfe
in allen Oberflächen auf den
Seiten 353–360.
Dispenser e pomoli abbinabili a tutte le superfici
alle pagine 353–360.

Preis CHF/Prezzo in CHF

	Name Nome	Modell Modello	Version / Oberfläche Versione / Superficie	Hansgrohe-Nr. N. di Hansgrohe	Artikel-Nr. N. di articolo	Exkl. MWST IVA esclusa	Inkl. MWST IVA inclusa
14	Talis S	Auszugsbrause Doccia estraibile	☆ Chrom Cromato	32841000	40.001.437.00 L C	430.–	465.–
15	Talis S	Schwenkauslauf Braccio girevole	Chrom Cromato	32851000	40.001.438.00 L C	307.–	332.–
16	Zesis M33-160	Auszugsbrause Doccia estraibile	Ⓢ Mittelhoher Auslauf / Chrom Bocca a media altezza / Cromato	74801000	40.002.431.00 L C	278.–	301.–
17			Ⓢ Mittelhoher Auslauf / Edelstahl-Finish Bocca a media altezza / Acciaio inox-finish	74801800	40.002.432.00 L C	363.–	392.–
18	Zesis M33-150	Auszugsbrause Doccia estraibile	Ⓢ Chrom Cromato	74800000	40.002.427.00 L C	194.–	210.–
19			Ⓢ Edelstahl-Finish Acciaio inox-finish	74800800	40.002.428.00 L C	254.–	275.–
20	Zesis M33-150	Schwenkauslauf Braccio girevole	Chrom Cromato	74802000	40.002.429.00 L C	139.–	150.–
21			Edelstahl-Finish Acciaio inox-finish	74802800	40.002.430.00 L C	182.–	197.–

hansgrohe

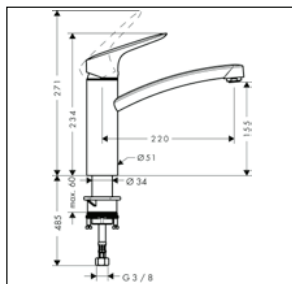
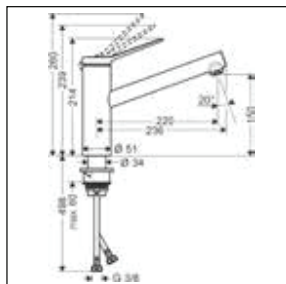

Kartusche keramisch
Cartuccia a dischi ceramic

Auslauf mit Metallschlauch
Doccia con flessibile in metallo

Schwenkbereich
Raggio d'azione

Flexible Anschlusschläuche
Raccordi flessibili

Durchfluss l/min. (3 bar)
Scarico l/min. (3 bar)

Mit Laminarstrahl
Con getto laminare

Auslauf mit Nylonschlauch
Doccia con flessibile in nylon

Preis CHF/Prezzo in CHF

Name Nome	Modell Modello	Version/Oberfläche Versione/Superficie	Hansgrohe-Nr. N. di Hansgrohe	Artikel-Nr. N. di articolo	Exkl. MWST IVA esclusa	Inkl. MWST IVA inclusa
22 Zesis M33-150	Schwenkauslauf Braccio girevole	Chrom Cromato	74813000	40.002.757.00	C 139.–	150.–
23 CoolStart		Edelstahl-Finish Acciaio inox-finish	74813800	40.002.758.00	C 182.–	197.–
24 Logis	Schwenkauslauf Braccio girevole	Chrom Cromato	71832000	40.001.672.00	C 140.–	151.–

DORN
BRACHT

Exklusiv bei Suter / Un'esclusiva di Suter

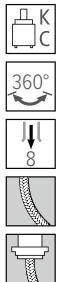
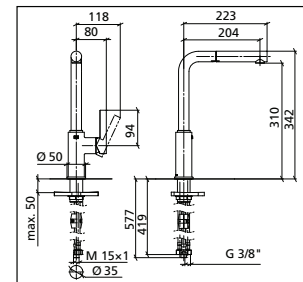
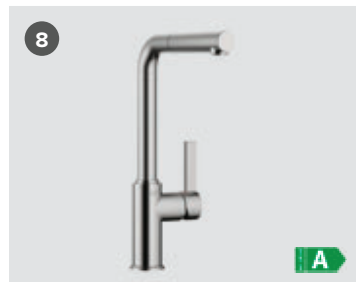
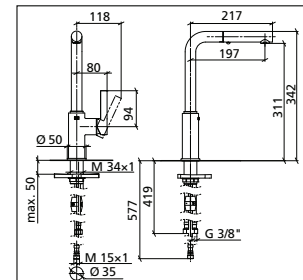
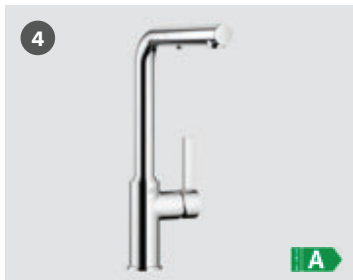
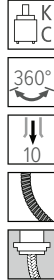
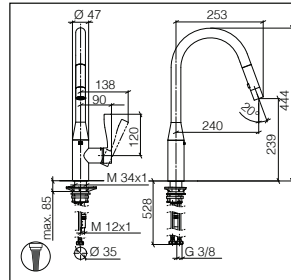
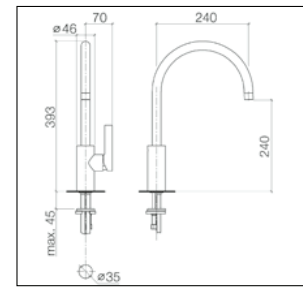
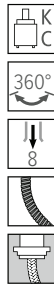
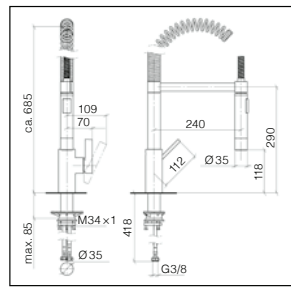
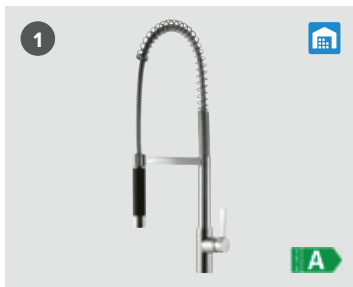

Preis CHF / Prezzo in CHF

	Name Nome	Modell Modello	Version / Oberfläche Versione / Superficie	Artikel-Nr. N. di articolo	Exkl. MWST IVA esclusa	Inkl. MWST IVA inclusa
1	Tara Ultra	Profibrausengarnitur Doccia professionale	* Ice	40.001.576.00	2133.–	2306.–
2	Tara Ultra*	Schwenkauslauf Braccio girevole	Ice	40.001.575.00	1028.–	1111.–
3	Sync	Auszugsbrause Doccia estraibile	Ⓜ * Ice	40.001.665.00	1345.–	1454.–
4	Koya	Auszugsbrause Doccia estraibile	Side lever L / Chrom Side lever L / Cromato	40.002.475.00	405.–	438.–
5			Side lever L / Edelstahl-Finish Side lever L / Acciaio inox-finish	40.002.476.00	508.–	549.–
6			Side lever L / Pulverbeschichtung schwarz, matt Side lever L / Rivestimento con polvere nero, opaco	40.002.477.00	508.–	549.–
7	Koya	Zugauslauf Boccaglio estraibile	Side lever L / Chrom Side lever L / Cromato	40.002.472.00	339.–	366.–
8			Side lever L / Edelstahl-Finish Side lever L / Acciaio inox-finish	40.002.473.00	443.–	479.–
9			Side lever L / Pulverbeschichtung schwarz, matt Side lever L / Rivestimento con polvere nero, opaco	40.002.474.00	443.–	479.–

* Mit Metallschlauch / Con flessibile in metallo ☆ Mit Nylonschlauch / Con flessibile in nylon *Modell ist mit Befestigungs-Set mit Befestigungsbügel (Hufeisen) ausgerüstet. Bei der Montage die mitgelieferte Verstärkungsplatte (Dreieck) verwenden.
 Ⓜ Mit Laminarstrahl / Con getto laminare *Il modello è dotato di set di fissaggio con staffa di fissaggio (a forma di ferro di cavallo). Utilizzare la piastra di rinforzo in dotazione (triangolo) per il montaggio.



Exklusiv bei Suter / Un'esclusiva di Suter

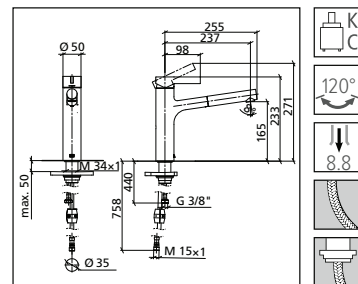
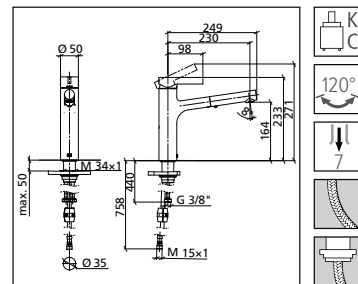
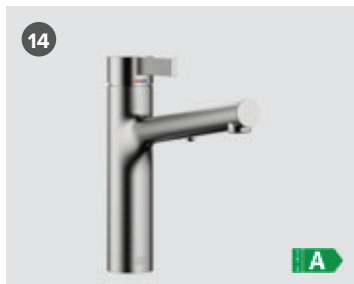
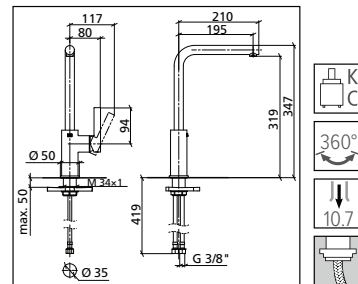
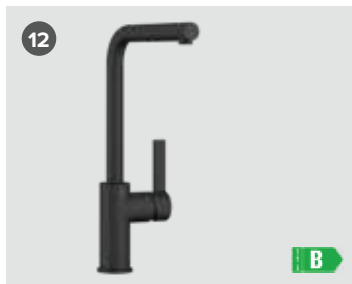
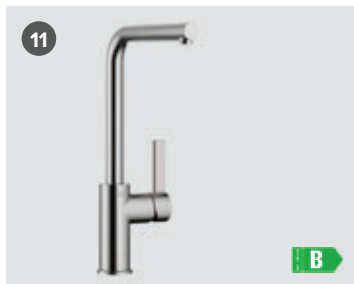

i Passende Dispenser und Zugknöpfe in allen Oberflächen auf den Seiten 353–360.
Dispenser e pomoli abbinabili a tutte le superfici alle pagine 353–360.

Kartusche keramisch
Cartuccia a dischi ceramic

Schwenkbereich
Raggio d'azione

Durchfluss l/min. (3 bar)
Scarico l/min. (3 bar)

Auslauf mit Nylonschlauch
Doccia con flessibile in nylon

Auslauf mit Metallschlauch
Doccia con flessibile in metallo

Flexible Anschlussschläuche
Raccordi flessibili

Mit Laminarstrahl
Con getto laminare

Preis CHF / Prezzo in CHF

Name Nome	Modell Modello	Version / Oberfläche Versione / Superficie	Artikel-Nr. N. di articolo	Exkl. MWST IVA esclusa	Inkl. MWST IVA inclusa
10	Koya Schwenkauslauf Braccio girevole	Side lever L / Chrom Side lever L / Cromato	40.002.469.00 L H	290.–	313.–
11		Side lever L / Edelstahl-Finish Side lever L / Acciaio inox-finish	40.002.470.00 L H	369.–	399.–
12		Side lever L / Pulverbeschichtung schwarz, matt Side lever L / Rivestimento con polvere nero, opaco	40.002.471.00 L H	369.–	399.–
13	Koya Auszugsbrause Doccia estraibile	Top lever / Chrom Top lever / Cromato	40.002.481.00 L H	452.–	489.–
14		Top lever / Edelstahl-Finish Top lever / Acciaio inox-finish	40.002.482.00 L H	534.–	577.–
15		Top lever / Pulverbeschichtung schwarz, matt Top lever / Rivestimento con polvere nero, opaco	40.002.483.00 L H	534.–	577.–
16	Koya Zugauslauf Boccaglio estraibile	Top lever / Chrom Top lever / Cromato	40.002.478.00 L H	369.–	399.–
17		Top lever / Edelstahl-Finish Top lever / Acciaio inox-finish	40.002.479.00 L H	470.–	508.–
18		Top lever / Pulverbeschichtung schwarz, matt Top lever / Rivestimento con polvere nero, opaco	40.002.480.00 L H	470.–	508.–

☆ Mit Nylonschlauch / Con flessibile in nylon

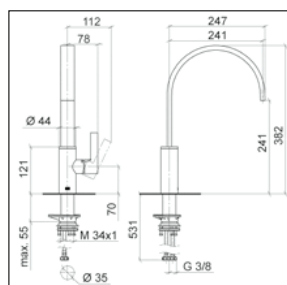
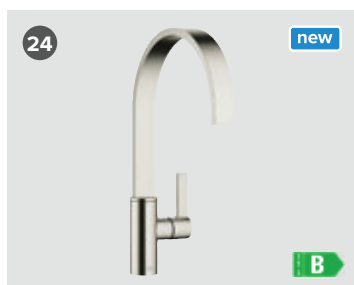
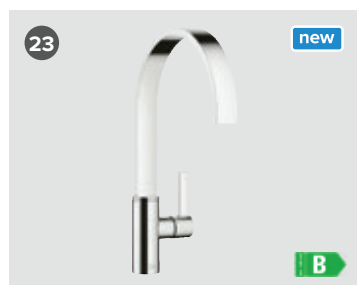
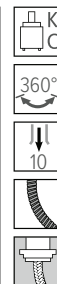
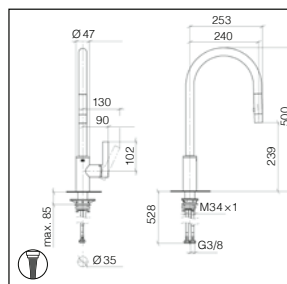
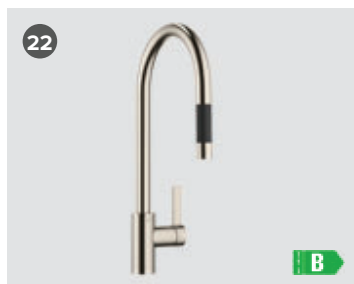
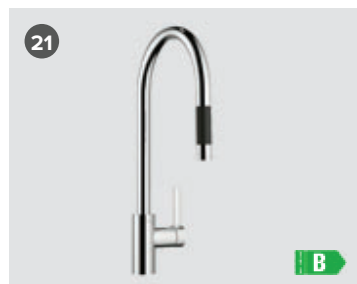
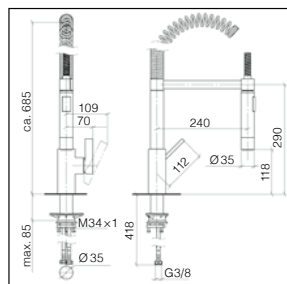
DORN
BRACHT

i Passende Dispenser und Zugknöpfe
in allen Oberflächen auf den
Seiten 353–360.
Dispenser e pomoli abbinabili a tutte le superfici
alle pagine 353–360.

Preis CHF/Prezzo in CHF

Name Nome	Modell Modello	Version / Oberfläche Versione / Superficie	Artikel-Nr. N. di articolo	Inkl. MWST IVA inclusa	Inkl. MWST Incl. TVA
19	Tara Ultra Profibrausengarnitur Doccia professionale	Chrom Cromato	33860875-00	40.001.416.00	L H 1333.– 1441.–
20		Platin, matt Platino, opaco	33860875-06	40.001.417.00	L H 2133.– 2306.–
21	Tara Ultra Auszugsbrause Doccia estraibile	Chrom Cromato	33870875-00	40.001.666.00	L H 760.– 822.–
22		Platin, matt Platino, opaco	33870875-06	40.001.667.00	L H 1217.– 1316.–
23	Mem Schwenkauslauf Braccio girevole	Chrom Cromato	33815682-00	40.002.733.00	L H 1119.– 1210.–
24		Platin, matt Platino, opaco	33815682-06	40.002.734.00	L H 1790.– 1935.–

* Mit Metallschlauch / Con flessibile in metallo

Ⓜ Mit Laminarstrahl / Con getto laminare

DORN
BRACHT

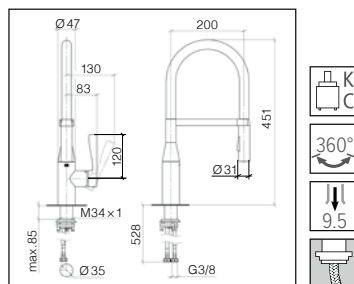
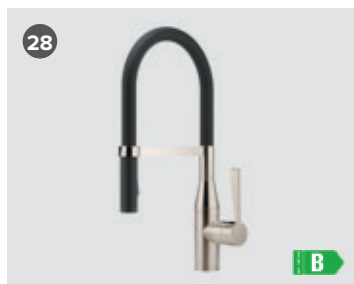
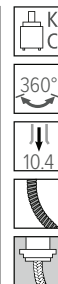
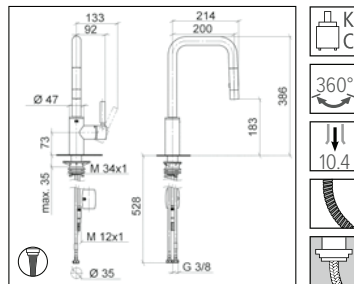
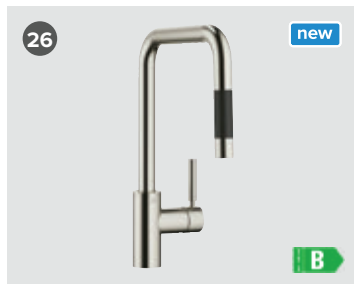

 Kartusche keramisch
Cartuccia a dischi ceramic

 Schwenkbereich
Raggio d'azione

 Durchfluss l/min. (3 bar)
Scarico l/min. (3 bar)





 Auslauf mit Nylonschlauch
Doccia con flessibile in nylon

 Auslauf mit Metallschlauch
Doccia con flessibile in metallo

 Flexible Anschlussschläuche
Raccordi flessibili

 Mit Laminarstrahl
Con getto laminare

Preis CHF/Prezzo in CHF

Name Nome	Modell Modello	Version / Oberfläche Versione / Superficie	Dornbracht-Nr. N. di Dornbracht	Artikel-Nr. N. di articolo	Exkl. MWST IVA esclusa	Inkl. MWST IVA inclusa
25 Meta Square	Auszugsbrause Doccia estraibile	Chrom Cromato	33870861-00	40.002.735.00  H	966.-	1044.-
		Platin, matt Platino, opaco	33870861-06	40.002.736.00  H	1545.-	1670.-
27 Sync	Profibrause Douchette professionale	Chrom Cromato	33865895-00	40.002.153.00  H	1092.-	1180.-
		Platin, matt Platino, mat	33865895-06	40.002.154.00  H	1747.-	1889.-

* Mit Metallschlauch / Con flessibile in metallo  Mit Laminarstrahl / Con getto laminare

GROHE

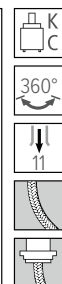
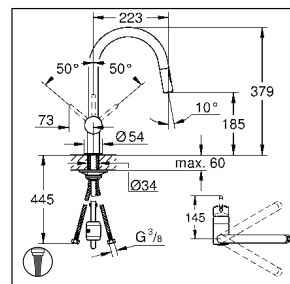
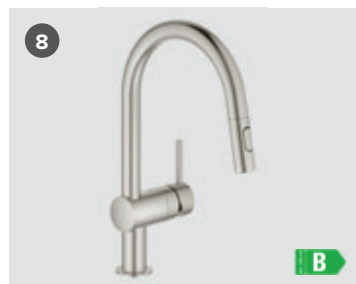
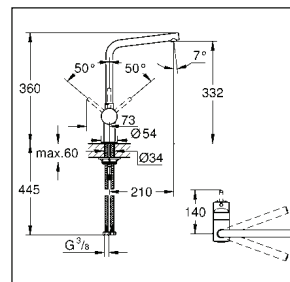
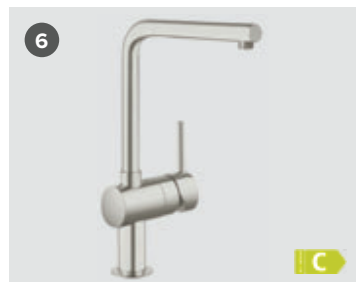
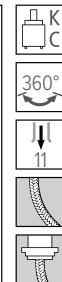
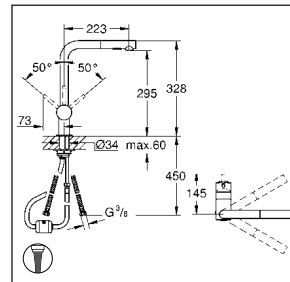
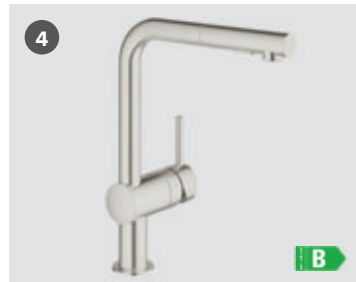
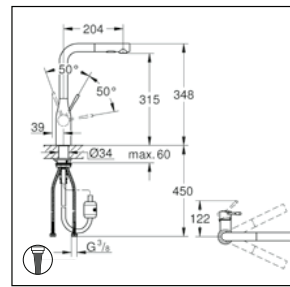
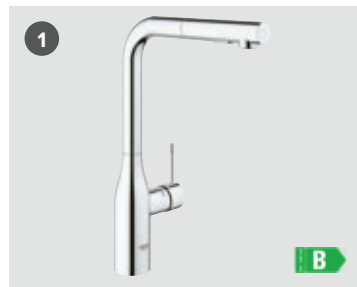

i Passende Dispenser und Zugknöpfe in allen Oberflächen auf den Seiten 353–360.
Dispenser e pomoli abbinabili a tutte le superfici alle pagine 353–360.

Preis CHF/Prezzo in CHF

Name Nome	Modell Modello	Version / Oberfläche Versione / Superficie	Grohe-Nr. N. di Grohe	Artikel-Nr. N. di articolo	Exkl. MWST IVA esclusa	Inkl. MWST IVA inclusa	
1 Essence	Auszugsbrause Doccia estraibile	Chrom Cromato	30 504 000	40.001.658.00	L G	421.–	455.–
		PVD-Beschichtung, Graphit Rivestimento a PVD, grafite	30 504 AL0	40.001.986.00	L G	631.–	682.–
3 Minta*	Auszugsbrause Doccia estraibile	Side lever L / Chrom Side lever L / Cromato	30 274 000	40.001.879.00	L G	335.–	362.–
		Side lever L / Edelstahl-Finish Side lever L / Acciaio inox-finish	30 274 DC0	40.001.880.00	L G	436.–	471.–
5 Minta*	Schwenkauslauf Braccio girevole	Side lever L / Chrom Side lever L / Cromato	31 375 000	40.001.877.00	L G	242.–	262.–
		Side lever L / Edelstahl-Finish Side lever L / Acciaio inox-finish	31 375 DC0	40.001.878.00	L G	315.–	341.–
7 Minta*	Auszugsbrause Doccia estraibile	Side lever C / Chrom Side lever C / Cromato	32 321 002	40.001.989.00	L G	281.–	304.–
		Side lever C / Edelstahl-Finish Side lever C / Acciaio inox-finish	32 321 DC2	40.001.990.00	L G	365.–	395.–

☆ Mit Nylonschlauch / Con flessibile in nylon

Ⓜ Mit Laminarstrahl / Con getto laminare

*Modell ist mit Befestigungs-Set mit Befestigungsbügel (Hufeisen) ausgerüstet. Bei der Montage die mitgelieferte Verstärkungsplatte (Dreieck) verwenden.

*Il modello è dotato di set di fissaggio con staffa di fissaggio (a forma di ferro di cavallo). Utilizzare la piastra di rinforzo in dotazione (triangolo) per il montaggio.

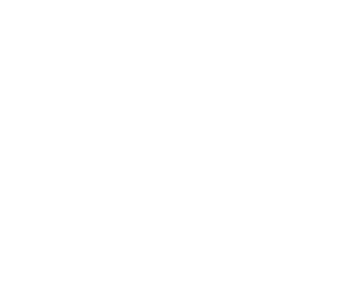
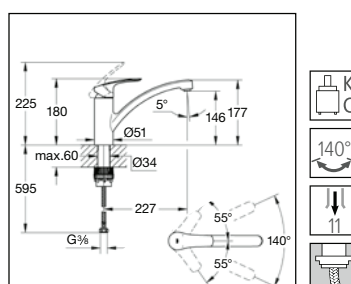
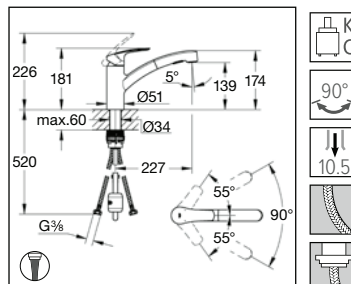
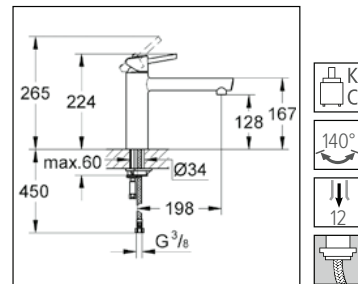
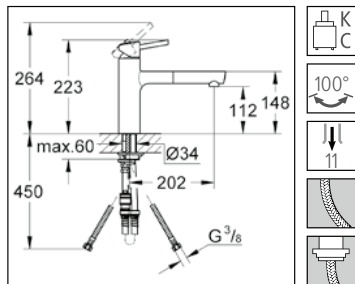

Kartusche keramisch
Cartuccia a dischi ceramic

Schwenkbereich
Raggio d'azione

Durchfluss l/min. (3 bar)
Scarico l/min. (3 bar)

Auslauf mit Nylonschlauch
Doccia con flessibile in nylon

Auslauf mit Metallschlauch
Doccia con flessibile in metallo

Flexible Anschlussschläuche
Raccordi flessibili

Mit Laminarstrahl
Con getto laminare

Preis CHF/Prezzo in CHF

Name Nome	Modell Modello	Version/Oberfläche Versione/Superficie	Grohe-Nr. N. di Grohe	Artikel-Nr. N. di articolo	Exkl. MWST IVA esclusa	Inkl. MWST IVA inclusa
9 Concetto*	Zugauslauf Boccaglio estraibile	☆ Chrom Cromato	31 129 001	40.001.174.00 L G	298.–	322.–
10 Concetto*	Schwenkauslauf Braccio girevole	Chrom Cromato	31 128 001	40.001.173.00 L G	245.–	265.–
11 Eurosmart	Auszugsbrause Doccia estraibile	☆ Chrom Cromato	30 305 001	40.002.216.00 L G	199.–	215.–
12 Eurosmart	Auszugsbrause Doccia estraibile	☆ Edelstahl-Finish Acciaio inox-finish	30 305 DC1	40.002.218.00 L G	259.–	280.–
13 Eurosmart	Schwenkauslauf Braccio girevole	Chrom Cromato	33 281 003	40.002.217.00 L G	139.–	150.–
14 Eurosmart	Schwenkauslauf Braccio girevole	☆ Edelstahl-Finish Acciaio inox-finish	33 281 DC3	40.002.219.00 L G	178.–	192.–

☆ Mit Nylonschlauch / Con flessibile in nylon

Ⓜ Mit Laminarstrahl / Con getto laminare

*Modell ist mit Befestigungs-Set mit Befestigungsbügel (Hufeisen) ausgerüstet. Bei der Montage die mitgelieferte Verstärkungsplatte (Dreieck) verwenden.

*Il modello è dotato di set di fissaggio con staffa di fissaggio (a forma di ferro di cavallo). Utilizzare la piastra di rinforzo in dotazione (triangolo) per il montaggio.



Oberflächen
Superfici



Chrom
Cromato



Ice
Ice



Edelstahl
Acciaio inox



Platin, matt
Platin, opaco

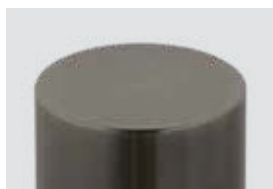

PVD-Beschichtung, Graphit
Rivestimento a PVD, grafite

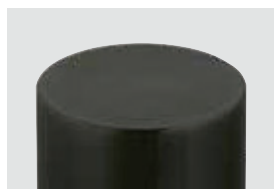

PVD-Beschichtung, Inox Black
Rivestimento a PVD, Inox Black



Pulverbeschichtung schwarz, matt
Rivestimento con polvere nero, opaco



Nasslackierung schwarz, seidenglanz
Verniciatura all'acqua, satinato lucido

Dispenser / Distributori

Ono	354
Style	354
Epoc	354
Ava	355
Little Joe	355
Artis	355
Pinocchio	355
Tarzan	356
Nano	356
Merano	357
Dornbracht	357

Zug-, Dreh- und Druckknöpfe
Pomoli / Pomoli girevoli / Pulsanti

Pinocchio	358
Advant	359
Prime	359
Dornbracht	359
Pico	360
Zugkabel	
Cable de tirette	360



Alle unsere Dispenser-Modelle können durch einfaches Abheben des Oberteils bequem nachgefüllt werden.
Tutti i nostri modelli di distributori di sapone si riempiono con facilità semplicemente sollevando la loro parte superiore.

Dispenser / Distributori

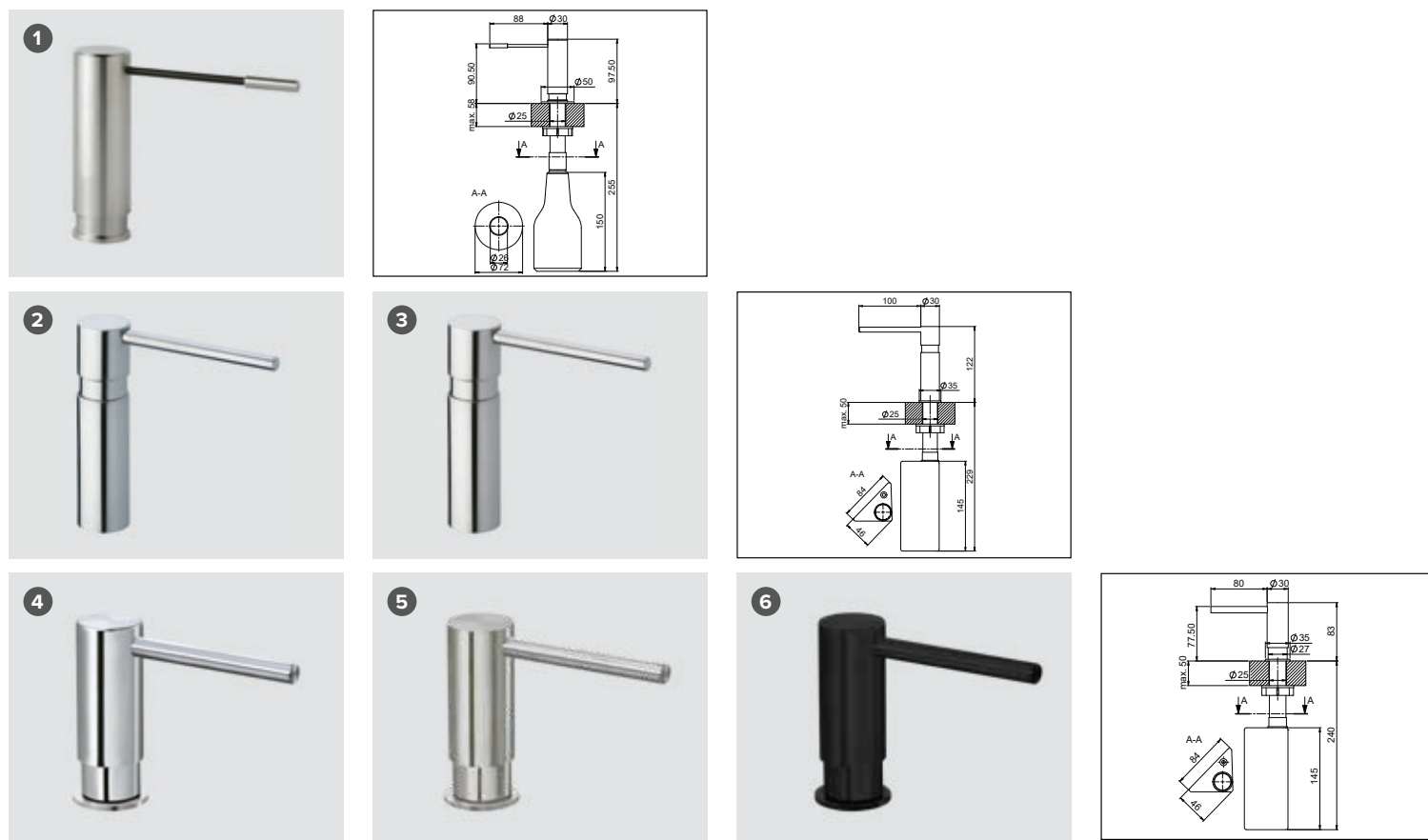

Preis CHF / Prezzo in CHF

Name Nome	Beschreibung Descrizione	Material/Oberfläche Materiale / Superficie	Artikel-Nr. N. di articolo	Exkl. MWST IVA esclusa	Inkl. MWST IVA inclusa
1 Ono*	Auslauf 88 mm, Sockel D = \varnothing 30 mm, mit Rosette D = \varnothing 50 mm Bocca 88 mm, zoccolo D = \varnothing 30 mm, con rosetta D = \varnothing 50 mm	Edelstahl Acciaio inox	40.001.044.00	C 452.–	489.–
2 Style*	Auslauf 100 mm, Sockel D = \varnothing 30 mm, mit Rosette D = \varnothing 35 mm	Messing, verchromt Ottone, cromato	40.000.927.00	G 206.–	223.–
3 Style*	Bocca 100 mm, zoccolo D = \varnothing 30 mm, con rosetta D = \varnothing 35 mm	Edelstahl Acciaio inox	40.000.929.00	G 326.–	352.–
4 Epoc	Auslauf 80 mm, Sockel D = \varnothing 27 mm, mit Rosette D = \varnothing 35 mm	Messing, verchromt Ottone, cromato	40.001.642.00	G 198.–	214.–
5 Epoc	Bocca 80 mm, zoccolo D = \varnothing 27 mm, con rosetta D = \varnothing 35 mm	Edelstahl Acciaio inox	40.001.643.00	G 313.–	338.–
6 Epoc		PVD-Beschichtung, Inox Black Rivestimento a PVD, Inox Black	40.002.526.00	G 432.–	467.–
Dispenser-Bohrung, D = \varnothing 25 mm, für alle Modelle Distributori: foro D = \varnothing 25 mm per tutti i modelli			40.000.188.00	D 87.–	94.–

* Kann mit oder ohne Rosette montiert werden / * Può essere montato con o senza rosetta Alle Preise verstehen sich exkl. Einbau des Dispensers! / Tutti i prezzi devono intendersi montaggio escluso.

Dispenser / Distributori

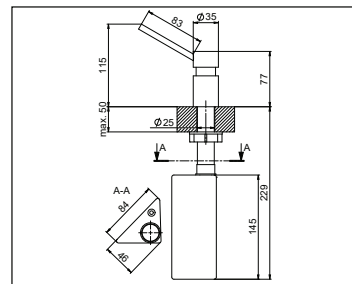
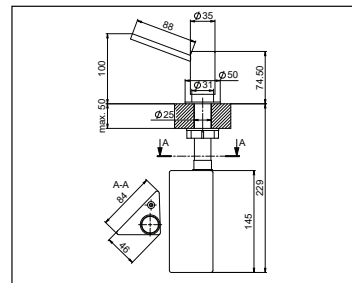
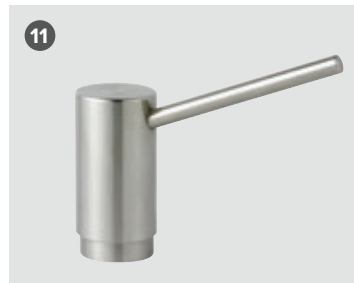
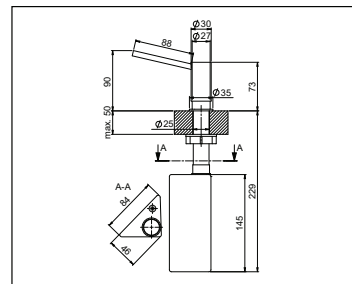
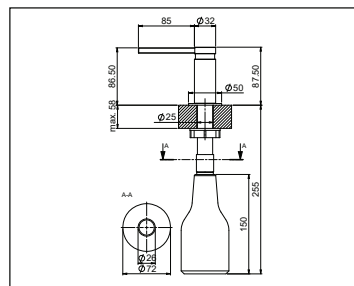

i Dispenser-Bohrung, D = \varnothing 25 mm, für alle Modelle
Distributori: foro D = \varnothing 25 mm per tutti i modelli

Preis CHF / Prezzo in CHF





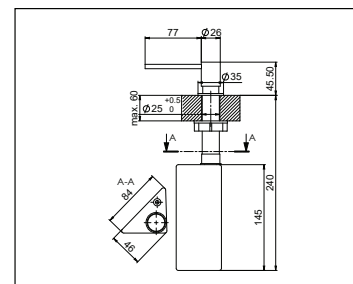
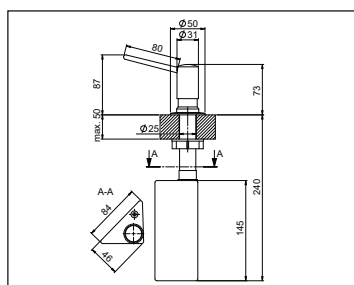
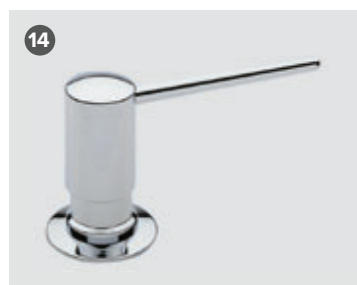

Name Nome	Beschreibung Descrizione	Material / Oberfläche Materiale / Superficie	Artikel-Nr. N. di articolo	Exkl. MWST IVA esclusa	Inkl. MWST IVA inclusa
7 Ava*	Auslauf 85 mm, Sockel D = \varnothing 32 mm, mit Rosette D = \varnothing 50 mm Bocca 85 mm, zoccolo D = \varnothing 32 mm, con rosetta D = \varnothing 50 mm	Messing, verchromt Ottone, cromato	40.001.130.00 L C	256.–	277.–
8 Little Joe	Auslauf 88 mm, Sockel D = \varnothing 27 mm, mit Rosette D = \varnothing 35 mm Bocca 88 mm, zoccolo D = \varnothing 27 mm, con rosetta D = \varnothing 35 mm	Messing, verchromt Ottone, cromato	40.001.131.00 L G	186.–	201.–
9		Edelstahl Acciaio inox	40.001.132.00 L G	302.–	326.–
10 Artis*	Auslauf 88 mm, Sockel D = \varnothing 31 mm, mit Rosette D = \varnothing 50 mm Bocca 88 mm, zoccolo D = \varnothing 31 mm, con rosetta D = \varnothing 50 mm	Messing, verchromt Ottone, cromato	40.001.125.00 L G	269.–	291.–
11		Edelstahl Acciaio inox	40.001.128.00 L G	402.–	435.–
12 Pinocchio	Auslauf 83 mm, Sockel D = \varnothing 35 mm, ohne Rosette Bocca 83 mm, zoccolo D = \varnothing 35 mm, senza rosetta	Messing, verchromt Ottone, cromato	40.000.923.00 L G	225.–	243.–
13		Edelstahl Acciaio inox	40.000.925.00 L G	374.–	404.–
Dispenser-Bohrung, D = \varnothing 25 mm, für alle Modelle Distributori: foro D = \varnothing 25 mm per tutti i modelli			40.000.188.00 D	87.–	94.–

* Kann mit oder ohne Rosette montiert werden / * Può essere montato con o senza rosetta Alle Preise verstehen sich exkl. Einbau des Dispensers! / Tutti i prezzi devono intendersi montaggio escluso.

Dispenser/Distributori



Preis CHF/Prezzo in CHF

Name Nome	Beschreibung Descrizione	Material/Oberfläche Materiale/Superficie	Artikel-Nr. N. di articolo	Exkl. MWST IVA esclusa	Inkl. MWST IVA inclusa
14 Tarzan	Auslauf 80 mm, Sockel D = \varnothing 31 mm, mit Rosette D = \varnothing 50 mm Bocca 80 mm, zoccolo D = \varnothing 31 mm, con rosetta D = \varnothing 50 mm	Messing, verchromt Ottone, cromato	40.000.176.00  G	152.–	164.–
15		Messing, verchromt Ottone, cromato	40.001.314.00  G	150.–	162.–
16		Edelstahl Acciaio inox	40.001.313.00  G	282.–	305.–
17		PVD-Beschichtung, Graphit Acciaio inox, con rivestimento a PVD, grafite	40.001.543.00  G	372.–	402.–
18 Nano	Auslauf 77 mm, Sockel D = \varnothing 35 mm Bocca 77 mm, zoccolo D = \varnothing 35 mm	PVD-Beschichtung, Inox Black Rivestimento a PVD, Inox Black	40.002.527.00  G	372.–	402.–
19		Pulverbeschichtung schwarz, matt Rivestimento con polvere nero, opaco	40.002.155.00  G	350.–	378.–
20		Nasslackierung schwarz, seiden glanz Verniciatura all'acqua, color nero satinato lucido	40.002.355.00  G	350.–	378.–
Dispenser-Bohrung, D = \varnothing 25 mm, für alle Modelle Distributori: foro D = \varnothing 25 mm per tutti i modelli			40.000.188.00	D 87.–	94.–

Alle Preise verstehen sich exkl. Einbau des Dispensers! / Tutti i prezzi devono intendersi montaggio escluso.

Dispenser / Distributori

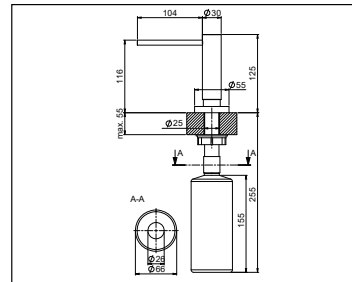
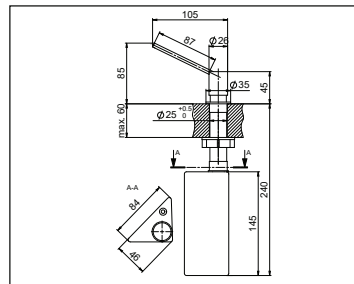
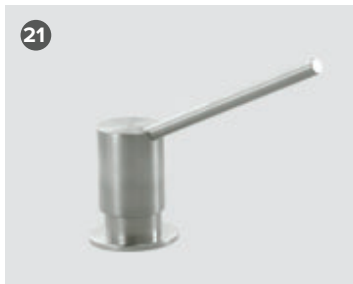

i **Dispenser-Bohrung, D = ø 25 mm, für alle Modelle (Toleranz für Nano, Merano siehe Zeichnungen)**
 Distributori: foro D = ø 25 mm per tutti i modelli (tolleranze per Nano, Merano come da disegni)

Preis CHF / Prezzo in CHF

Name Nome	Beschreibung Descrizione	Material / Oberfläche Materiale / Superficie	Artikel-Nr. N. di articolo	Exkl. MWST IVA esclusa	Inkl. MWST IVA inclusa
21 Merano	Auslauf 87 mm, Sockel D = ø 35 mm Bocca 87 mm, zoccolo D = ø 35 mm	Edelstahl Acciaio inox	40.001.434.00	G 321.–	347.–
22 Dornbracht	Auslauf 104 mm, Sockel D = ø 30 mm, mit Rosette D = ø 55 mm Bocca 104 mm, zoccolo D = ø 30 mm, con rosetta D = ø 55 mm	Messing, verchromt Ottone, cromato	40.001.424.00	H 252.–	272.–
23 Dornbracht	Auslauf 104 mm, Sockel D = ø 30 mm, mit Rosette D = ø 55 mm Bocca 104 mm, zoccolo D = ø 30 mm, con rosetta D = ø 55 mm	Platin, matt Platino, opaco	40.001.425.00	H 403.–	436.–
Dispenser-Bohrung, D = ø 25 mm, für alle Modelle Distributori: foro D = ø 25 mm per tutti i modelli			40.000.188.00	D 87.–	94.–

Alle Preise verstehen sich exkl. Einbau des Dispensers! / Tutti i prezzi devono intendersi montaggio escluso.

Zug-, Dreh- und Druckknöpfe

Pomoli/Pomoli girevoli/Pulsanti

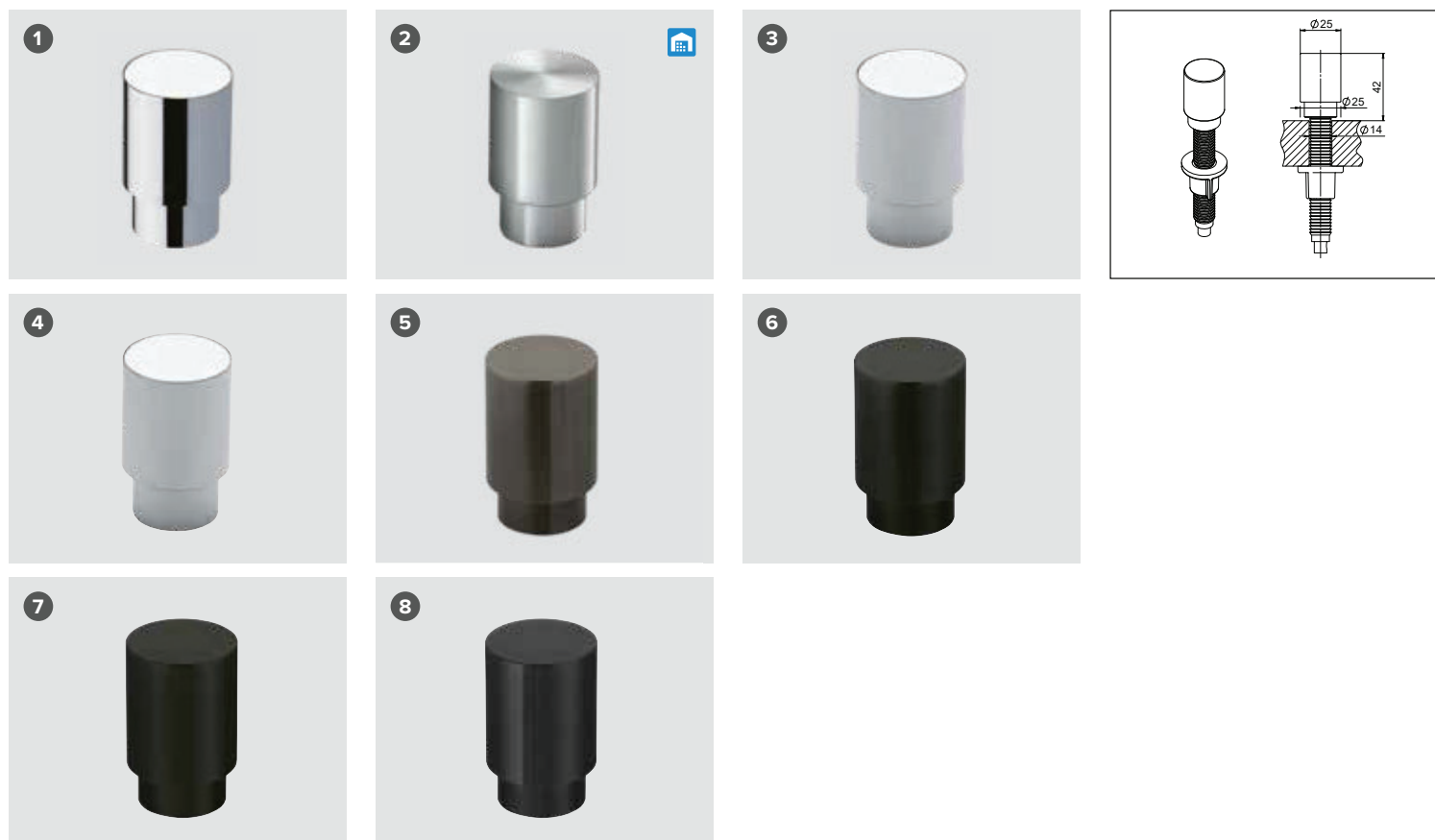

Preis CHF/Prezzo in CHF

Name Nome	Beschreibung Descrizione	Material / Oberfläche Materiale / Superficie	Artikel-Nr. N. di articolo	Exkl. MWST IVA esclusa	Inkl. MWST IVA inclusa	
1 2 3 4 5 6 7 8 Pinocchio*	Zugknopf, komplett, massiv Metall, mit Rosette D = ø 25 mm Pomolo, completo, metallo massiccio, con rosetta D = ø 25 mm	Messing, verchromt Ottone, cromato	40.000.931.00	F	54.–	58.–
		Austausch Zugknopf** Pomolo di ricambio**	40.000.931.01	F	30.–	32.–
		Ice	40.001.580.00	F	132.–	143.–
		Austausch Zugknopf** Pomolo di ricambio**	40.001.580.01	F	108.–	117.–
		Edelstahl Acciaio inox	40.000.933.00	F	107.–	116.–
		Austausch Zugknopf** Pomolo di ricambio**	40.000.933.01	F	83.–	90.–
		Platin, matt Platino, opaco	40.001.454.00	F	132.–	143.–
		Austausch Zugknopf** Pomolo di ricambio**	40.001.454.01	F	108.–	117.–
		PVD-Beschichtung, Graphit Rivestimento a PVD, grafite	40.001.283.00	F	132.–	143.–
		Austausch Zugknopf** Pomolo di ricambio**	40.001.283.01	F	108.–	117.–
		PVD-Beschichtung, Inox Black Rivestimento a PVD, Inox Black	40.002.528.00	F	132.–	143.–
		Austausch Zugknopf** Pomolo di ricambio**	40.002.528.01	F	108.–	117.–
		Pulverbeschichtung schwarz, matt / Rivestimento con polvere nero, opaco	40.002.156.00	F	125.–	135.–
		Austausch Zugknopf** Pomolo di ricambio**	40.002.156.01	F	101.–	109.–
		Nasslackierung schwarz, seidenglanz / Verniciatura all'acqua, color nero satinato lucido	40.002.356.00	F	125.–	135.–
		Austausch Zugknopf** Pomolo di ricambio**	40.002.356.01	F	101.–	109.–

* Kann mit oder ohne Rosette montiert werden / Può essere montato con o senza rosetta

** Nur in Verbindung mit ausgewählten Spülen und Becken erhältlich / Solo in abbinamento a lavelli e lavabi selezionati

Zug-, Dreh- und Druckknöpfe

Pomoli/Pomoli girevoli/Pulsanti

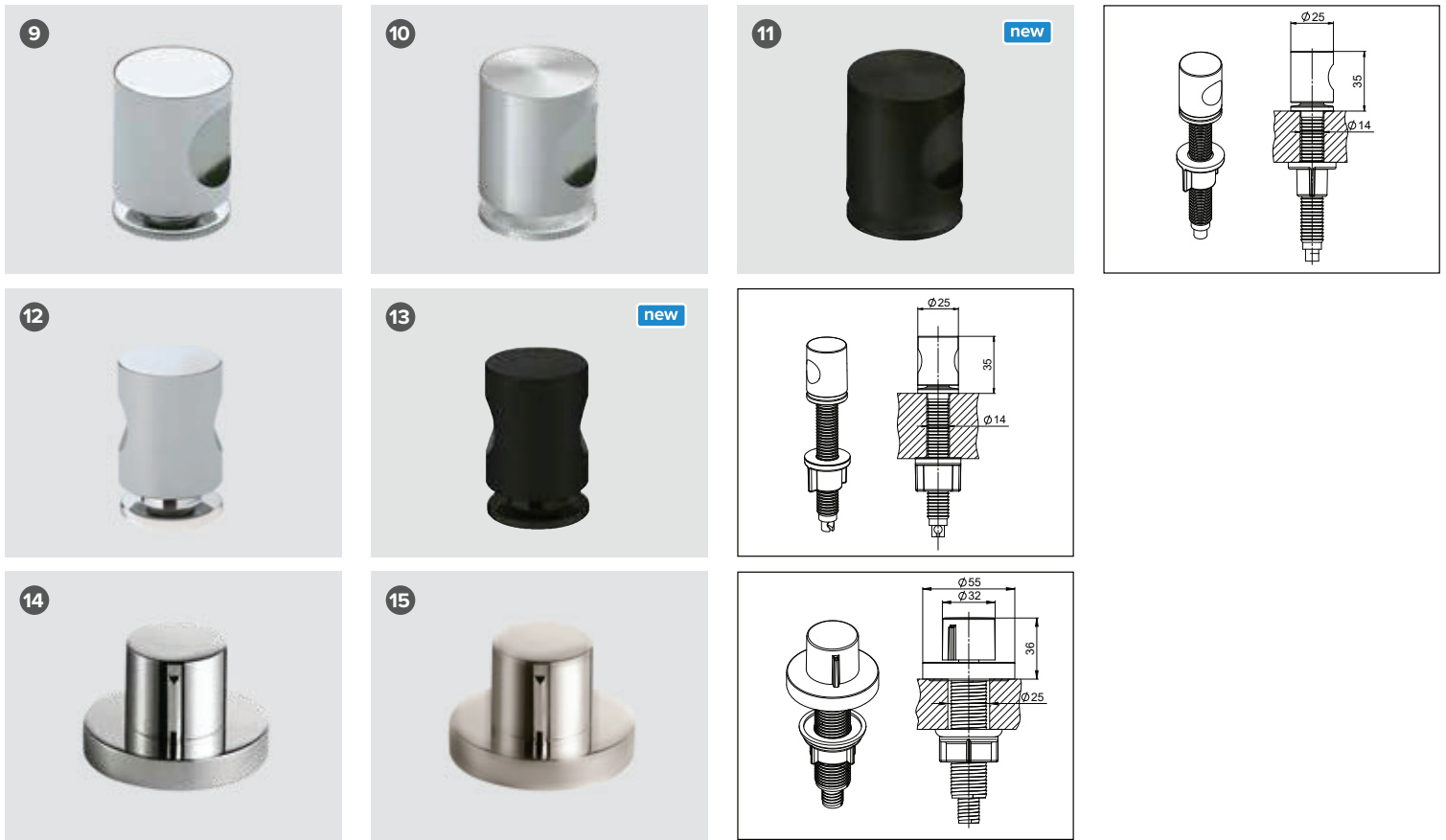

i Zugknopf-Bohrung für Pinocchio, Advant, Prime, Pico D = ø 14 mm
 Pomolo: foro per Pinocchio, Advant, Prime, Pico D = ø 14 mm

Drehknopf-Bohrung für Dornbracht, D = ø 25 mm
 Pomolo girevole: foro per Dornbracht, D = ø 25 mm

Preis CHF/Prezzo in CHF

Name Nome	Beschreibung Descrizione	Material/Oberfläche Materiale/Superficie	Artikel-Nr. N. di articolo	Exkl. MWST IVA esclusa	Inkl. MWST IVA inclusa	
9 10 11 Advant	Zugknopf, komplett, massiv Metall, mit Sockel D = ø 25 mm Pomolo, completo, metallo massiccio, con zoccolo D = ø 25 mm	Messing, verchromt Ottone, cromato	40.000.935.00	F	27.–	29.–
		Austausch Zugknopf** Pomolo di ricambio**	40.000.935.01	F	3.–	4.–
		Edelstahl Acciaio inox	40.002.546.00	F	56.–	61.–
12 13 Prime	Zugknopf, komplett, Kunststoff, mit Sockel D = ø 25 mm Pomolo, completo, plastica, con zoccolo D = ø 25 mm	Austausch Zugknopf** Pomolo di ricambio**	40.002.546.01	F	32.–	35.–
		Pulverbeschichtung schwarz, matt/Rivestimento con polvere nero, opaco	40.002.766.00	F	74.–	80.–
		Austausch Zugknopf** Pomolo di ricambio**	40.002.766.01	F	50.–	54.–
14 15 Dorn- bracht*	Drehknopf-Garnitur, komplett, mit Rosette D = ø 55 mm Pomolo girevole, completo, con rosetta D = ø 55 mm	ABS-Kunststoff, verchromt ABS, cromato	40.001.006.00	F	22.–	24.–
		Edelstahl Acciaio inox	40.002.546.00	F	56.–	61.–
		Austausch Zugknopf** Pomolo di ricambio**	40.002.765.01	F	0.–	0.–
		Pulverbeschichtung schwarz, matt/Rivestimento con polvere nero, opaco	40.002.765.00	F	24.–	26.–
14 15 Dorn- bracht*	Drehknopf-Garnitur, komplett, mit Rosette D = ø 55 mm Pomolo girevole, completo, con rosetta D = ø 55 mm	Messing, verchromt Ottone, cromato	40.001.422.00	H	163.–	176.–
		Austausch Drehknopf** Pomolo girevole di ricambio**	40.001.422.01	H	139.–	150.–
		Platin, matt Platino, opaco	40.001.423.00	H	260.–	281.–
15		Austausch Drehknopf** Pomolo girevole di ricambio**	40.001.423.01	H	236.–	255.–

* Nicht kompatibel mit Raumspar Desino / Non compatibile con salvaspazio Desino

** Nur in Verbindung mit ausgewählten Spülen und Becken erhältlich / Solo in abbinamento a lavelli e lavabi selezionati

Zug-, Dreh- und Druckknöpfe

Pomoli/Pomoli girevoli/Pulsanti

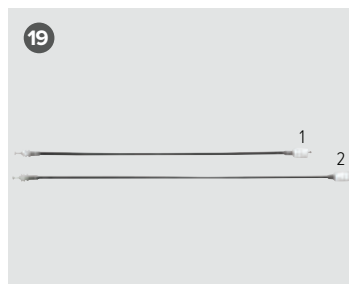
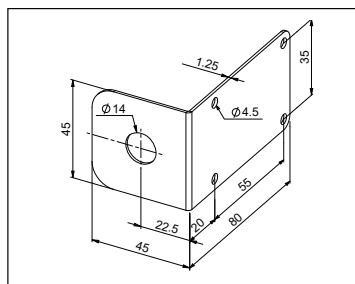
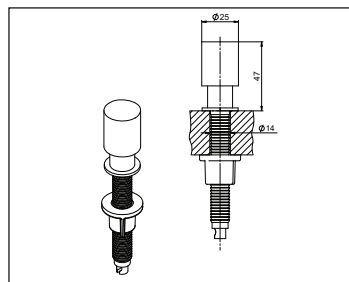

i Zugknopf-Bohrung für Pinocchio, Advant, Prime, Pico D = \varnothing 14 mm
 Pomolo: foro per Pinocchio, Advant, Prime, Pico D = \varnothing 14 mm

Drehknopf-Bohrung für Dornbracht, D = \varnothing 25 mm
 Pomolo girevole: foro per Dornbracht, D = \varnothing 25 mm

Preis CHF/Prezzo in CHF

Name Nome	Beschreibung Descrizione	Material/Oberfläche Materiale/Superficie	Artikel-Nr. N. di articolo	Exkl. MWST IVA esclusa	Inkl. MWST IVA inclusa	
16	Druckknopf, komplett, massiv Metall, mit Rosette D = \varnothing 25 mm Pulsante, completo, metallo massiccio, con rosetta D = \varnothing 25 mm	Messing, verchromt Ottone, cromato	40.001.259.00	F	71.–	77.–
		Austausch Druckknopf **** Pulsante di ricambio ****	40.001.259.01	F	47.–	51.–
17		Edelstahl Acciaio inox	40.001.260.00	F	142.–	154.–
		Austausch Druckknopf **** Pulsante di ricambio ****	40.001.260.01	F	118.–	128.–
18	Unterschrank-Montagewinkel für Zug- oder Druckknopf Staffa angolare di montaggio per base del pomolo o del pulsante	Edelstahl Acciaio inox	40.001.469.00	F	32.–	35.–
19	1 Zugkabel, Länge 635 mm, komplett Tirante, lungh. 635 mm, completo	PE-POM-18/10, schwarz	40.000.152.00	F	34.–	37.–
	2 Zugkabel, Länge 1000 mm, komplett Tirante, lungh. 1000 mm, completo	PE-POM-18/10, nero	40.000.383.00	F	45.–	49.–

* Kann mit oder ohne Rosette montiert werden / Può essere montato con o senza rosetta

*** Nicht kompatibel mit Raumspar Desino / Non compatibile con salvaspazio Desino

** Einbau nicht kompatibel mit Brooklyn Becken / Montaggio incompatibile con il lavello Brooklyn

**** Nur in Verbindung mit ausgewählten Spülen und Becken erhältlich / Solo in abbinamento a lavelli e lavabi selezionati

Abfall-Systeme**Sistemi di raccolta rifiuti**

Müllex D-Line	362
Müllex X-Line: Set-Angebote	
Müllex X-Line: Offerta di set	364
Müllex X-Line: Einzelkomponenten	
Müllex X-Line: Componenti singoli	368
Müllex BOXX 40-R	371
Müllex Euro BOXX 40-R	371
Müllex BOXX 55/60-R BIO	371
Müllex Euro BOXX 55/60-R	371
Müllex Comfort 35/5	371
Müllex Heavy Bag	372

Masszeichnungen

Disegni tecnici	373
------------------------	------------

Müllex D-Line / Müllex D-Line

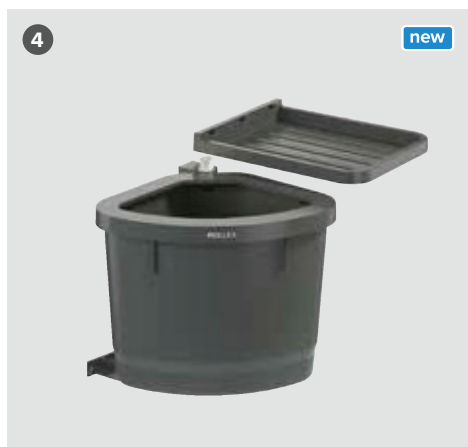
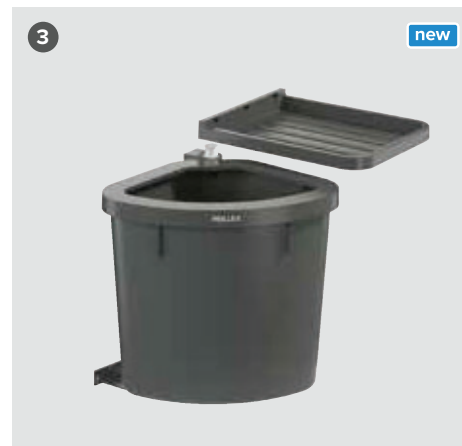
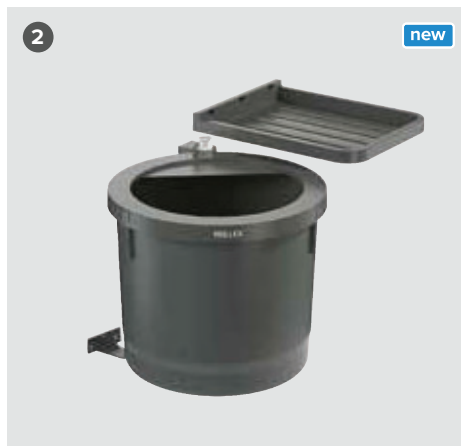
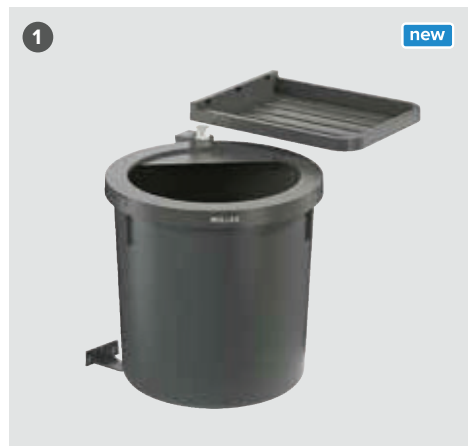



Preis CHF / Prezzo in CHF

Modell Modello	Beschreibung Descrizione	Müllex-Nr. N. di Müllex	Artikel-Nr. N. di articolo	Exkl. MWST IVA esclusa	Inkl. MWST IVA inclusa
1 D50 L1, Einbauhöhe L, 440 mm Altezza d'ingombro L, 440 mm	System für Drehtüren / ab 500 mm Korpusbreite / 35 oder 17 Liter Abfallsäcke / praktischer Ablagedeckel / Volumen 35 Liter Sistema per porte a battente / corpo a partire da 500 mm / per sacchi da 35 o 17 litri / pratico coperchio di contenimento / volume 35 litri	80.71.101	40.002.646.00 L G	106.–	115.–
2 D50 M1, Einbauhöhe M, 390 mm Altezza d'ingombro M, 390 mm	Niedriges System für Drehtüren / ab 500 mm Korpusbreite / 35 oder 17 Liter Abfallsäcke / praktischer Ablagedeckel / Volumen 30 Liter Sistema basso per porte a battente / corpo a partire da 500 mm / per sacchi da 35 o 17 litri / pratico coperchio di contenimento / volume 30 litri	80.71.102	40.002.647.00 L G	106.–	115.–
3 D40 L3, Einbauhöhe L, 440 mm Altezza d'ingombro L, 440 mm	System für Drehtüren / ab 400 mm Korpusbreite / 35 oder 17 Liter Abfallsäcke / praktischer Ablagedeckel / Volumen 25 Liter Sistema per porte a battente / corpo a partire da 400 mm / per sacchi da 35 o 17 litri / pratico coperchio di contenimento / volume 25 litri	80.71.001	40.002.648.00 L G	96.–	104.–
4 D40 M3, Einbauhöhe M, 390 mm Altezza d'ingombro M, 390 mm	Niedriges System für Drehtüren / ab 400 mm Korpusbreite / 35 oder 17 Liter Abfallsäcke / praktischer Ablagedeckel / Volumen 21 Liter Sistema basso per porte a battente / corpo a partire da 400 mm / per sacchi da 35 o 17 litri / pratico coperchio di contenimento / volume 21 litri	80.71.002	40.002.649.00 L G	96.–	104.–

Müllex D-Line / Müllex D-Line



Preis CHF / Prezzo in CHF

Modell Modello	Beschreibung Descrizione	Müllex-Nr. N. di Müllex	Artikel-Nr. N. di articolo	Exkl. MWST IVA esclusa	Inkl. MWST IVA inclusa
5 Trennsteg D1 Separatore D1	Der Trennsteg D1 ist speziell für D50 Drehtürsysteme ausgelegt / unterteilt den Hauptbehälter so, dass zwei 17 Liter Abfallsäcke eingespannt werden können Il divisorio D1 è stato progettato appositamente per i sistemi a porte girevoli D50 / divide il contenitore principale in modo da poter bloccare due sacchi di rifiuti da 17 litri	12970	40.002.650.00  G	19.–	21.–
6 Trennsteg D3 Separatore D3	Der Trennsteg D3 ist speziell für D40 Drehtürsysteme ausgelegt / unterteilt den Hauptbehälter so, dass zwei 17 Liter Abfallsäcke eingespannt werden können Il separatore D3 è stato progettato appositamente per i sistemi a porte girevoli D40 / divide il contenitore principale in modo da poter bloccare due sacchi di rifiuti da 17 litri	12977	40.002.651.00  G	19.–	21.–

Müllex X-Line: Set-Angebote / Müllex X-Line: Offerta di set



Preis CHF / Prezzo in CHF

Modell Modello	Set bestehend aus Set costituito da	Müllex-Nr. N. di Müllex	Artikel-Nr. N. di articolo	Exkl. MWST IVA esclusa	Inkl. MWST IVA inclusa
1 X45 L35 Basic, Einbauhöhe L, 414 mm Altezza d'ingombro L, 414 mm	Schublade Basic 450 mm 80.41.101+ Abfalltrennbehälter X45 L35 80.51.101 System für bestehende Schubladenauszüge, Korpusbreite 450 mm Cassetto Basic 450 mm 80.41.101+ Contentitore per separazione rifiuti X45 L35 80.51.101 Sistema per guide cassetti esistenti, larghezza modulo 450 mm	80.50.101	40.002.270.00 L G	179.–	193.–
2 X45 M35 Basic, Einbauhöhe M, 367 mm Altezza d'ingombro M, 367 mm	Schublade Basic 450 mm 80.41.101+ Abfalltrennbehälter X45 M35 80.51.102 System für bestehende Schubladenauszüge, Korpusbreite 450 mm Cassetto Basic 450 mm 80.41.101+ Contentitore per separazione rifiuti X45 M35 80.51.102 Sistema per guide cassetti esistenti, larghezza modulo 450 mm	80.50.103	40.002.271.00 L G	179.–	193.–
2 X50 L35 Basic, Einbauhöhe L, 414 mm Altezza d'ingombro L, 414 mm	Schublade Basic 500 mm 80.41.201+ Abfalltrennbehälter X45 L35, 80.51.101 System für bestehende Schubladenauszüge, Korpusbreite 500 mm Cassetto Basic 500 mm 80.41.201+ Contentitore per separazione rifiuti X45 L35, 80.51.101 Sistema per guide cassetti esistenti, larghezza modulo 500 mm	80.50.201	40.002.272.00 L G	179.–	193.–
2 X50 M35 Basic, Einbauhöhe M, 367 mm Altezza d'ingombro M, 367 mm	Schublade Basic 500 mm 80.41.201+ Abfalltrennbehälter X45 M35 80.51.102 System für bestehende Schubladenauszüge, Korpusbreite 500 mm Cassetto Basic 500 mm 80.41.201+ Contentitore per separazione rifiuti X45 M35 80.51.102 Sistema per guide cassetti esistenti, larghezza modulo 500 mm	80.50.203	40.002.273.00 L G	179.–	193.–
3 X55 L7 Basic, Einbauhöhe L, 414 mm Altezza d'ingombro L, 414 mm	Schublade Basic 550 mm 80.41.301+ Abfalltrennbehälter X55 L7 80.51.303 System für bestehende Schubladenauszüge, Korpusbreite 550 mm Cassetto Basic 550 mm 80.41.301+ Contentitore per separazione rifiuti X55 L7 80.51.303 Sistema per guide cassetti esistenti, larghezza modulo 550 mm	80.50.305	40.002.446.00 L G	203.–	219.–
3 X55 M7 Basic, Einbauhöhe M, 367 mm Altezza d'ingombro M, 367 mm	Schublade Basic 550 mm 80.41.301+ Abfalltrennbehälter X55 M7 80.51.304 System für bestehende Schubladenauszüge, Korpusbreite 550 mm Cassetto Basic 550 mm 80.41.301+ Contentitore per separazione rifiuti X55 M7 80.51.304 Sistema per guide cassetti esistenti, larghezza modulo 550 mm	80.50.307	40.002.447.00 L G	203.–	219.–

Müllex X-Line: Set-Angebote / Müllex X-Line: Offerta di set



Preis CHF / Prezzo in CHF

Modell Modello	Set bestehend aus Set costituito da	Müllex-Nr. N. di Müllex	Artikel-Nr. N. di articolo	Exkl. MWST IVA esclusa	Inkl. MWST IVA inclusa
4 X55 L5 Basic, Einbauhöhe L, 414 mm Altezza d'ingombro L, 414 mm	Schublade Basic 550 mm 80.41.301+ Abfalltrennbehälter X55 L5 80.51.301 System für bestehende Schubladenauszüge, Korpusbreite 550 mm Cassetto Basic 550 mm 80.41.301+ Contentitore per separazione rifiuti X55 L5 80.51.301 Sistema per guide cassetti esistenti, larghezza modulo 550 mm	80.50.301	40.002.274.00 L G	232.–	251.–
5 X55 M5 Basic, Einbauhöhe M, 367 mm Altezza d'ingombro M, 367 mm	Schublade Basic 550 mm 80.41.301+ Abfalltrennbehälter X55 M5 80.51.302 System für bestehende Schubladenauszüge, Korpusbreite 550 mm Cassetto Basic 550 mm 80.41.301+ Contentitore per separazione rifiuti X55 M5 80.51.302 Sistema per guide cassetti esistenti, larghezza modulo 550 mm	80.50.303	40.002.275.00 L G	232.–	251.–
5 X60 L7 Basic, Einbauhöhe L, 414 mm Altezza d'ingombro L, 414 mm	Schublade Basic 600 mm 80.41.401+ Abfalltrennbehälter X60 L7 80.51.403 System für bestehende Schubladenauszüge, Korpusbreite 600 mm Cassetto Basic 600 mm 80.41.401+ Contentitore per separazione rifiuti X60 L7 80.51.403 Sistema per guide cassetti esistenti, larghezza modulo 600 mm	80.50.405	40.002.448.00 L G	203.–	219.–
5 X60 M7 Basic, Einbauhöhe M, 367 mm Altezza d'ingombro M, 367 mm	Schublade Basic 600 mm 80.41.401+ Abfalltrennbehälter X60 M7 80.51.404 System für bestehende Schubladenauszüge, Korpusbreite 600 mm Cassetto Basic 600 mm 80.41.401+ Contentitore per separazione rifiuti X60 M7 80.51.404 Sistema per guide cassetti esistenti, larghezza modulo 600 mm	80.50.407	40.002.449.00 L G	203.–	219.–
6 X60 L5 Basic, Einbauhöhe L, 414 mm Altezza d'ingombro L, 414 mm	Schublade Basic 600 mm 80.41.401+ Abfalltrennbehälter X60 L5 80.51.401 System für bestehende Schubladenauszüge, Korpusbreite 600 mm Cassetto Basic 600 mm 80.41.401+ Contentitore per separazione rifiuti X60 L5 80.51.401 Sistema per guide cassetti esistenti, larghezza modulo 600 mm	80.50.401	40.002.278.00 L G	232.–	251.–
6 X60 M5 Basic, Einbauhöhe M, 367 mm Altezza d'ingombro M, 367 mm	Schublade Basic 600 mm 80.41.401+ Abfalltrennbehälter X60 M5 80.51.402 System für bestehende Schubladenauszüge, Korpusbreite 600 mm Cassetto Basic 600 mm 80.41.401+ Contentitore per separazione rifiuti X60 M5 80.51.402 Sistema per guide cassetti esistenti, larghezza modulo 600 mm	80.50.403	40.002.279.00 L G	232.–	251.–

Müllex X-Line: Set-Angebote / Müllex X-Line: Offerta di set



Preis CHF / Prezzo in CHF

Modell Modello	Set bestehend aus Set costituito da	Müllex-Nr. N. di Müllex	Artikel-Nr. N. di articolo	Exkl. MWST IVA esclusa	Inkl. MWST IVA inclusa
7 X80 L6 Basic, Einbauhöhe L, 414 mm Altezza d'ingombro L, 414 mm	Deckel Basic 800 mm 80.41.501+ Abfalltrennbehälter X80 L6 80.51.501 System für bestehende Schubladenauszüge, Korpusbreite 800 mm Coperchio Basic 800 mm 80.41.501+ Contentitore per separazione rifiuti X80 L6 80.51.501 Sistema per guide cassetti esistenti, larghezza modulo 800 mm	80.50.501	40.002.282.00 L G	328.–	355.–
8 X90 L6 Basic, Einbauhöhe L, 414 mm Altezza d'ingombro L, 414 mm	Deckel Basic 900 mm 80.41.601+ Abfalltrennbehälter X80 L6 80.51.501 System für bestehende Schubladenauszüge, Korpusbreite 900 mm Coperchio Basic 900 mm 80.41.601+ Contentitore per separazione rifiuti X80 L6 80.51.501 Sistema per guide cassetti esistenti, larghezza modulo 900 mm	80.50.601	40.002.283.00 L G	328.–	355.–
9 X55 L7 Premium, Einbauhöhe L, 414 mm Altezza d'ingombro L, 414 mm	Schublade Premium 550 mm 80.42.301+ Abfalltrennbehälter X55 L7 80.51.303 System für bestehende Schubladenauszüge, Korpusbreite 550 mm Cassetto Premium 550 mm 80.42.301+ Contentitore per separazione rifiuti X55 L7 80.51.303 Sistema per guide cassetti esistenti, larghezza modulo 550 mm	80.50.306	40.002.450.00 L G	249.–	269.–
X55 M7 Premium, Einbauhöhe M, 367 mm Altezza d'ingombro M, 367 mm	Schublade Premium 550 mm 80.42.301+ Abfalltrennbehälter X55 M7 80.51.304 System für bestehende Schubladenauszüge, Korpusbreite 550 mm Cassetto Premium 550 mm 80.42.301+ Contentitore per separazione rifiuti X55 M7 80.51.304 Sistema per guide cassetti esistenti, larghezza modulo 550 mm	80.50.308	40.002.451.00 L G	249.–	269.–

Müllex X-Line: Set-Angebote / Müllex X-Line: Offerta di set



Preis CHF / Prezzo in CHF

Modell Modello	Set bestehend aus Set costituito da	Müllex-Nr. N. di Müllex	Artikel-Nr. N. di articolo	Exkl. MWST IVA esclusa	Inkl. MWST IVA inclusa
10 X55 L5 Premium, Einbauhöhe L, 414 mm Altezza d'ingombro L, 414 mm	Schublade Premium 550 mm 80.42.301+ Abfalltrennbehälter X55 L5 80.51.301 System für bestehende Schubladenauszüge, Korpusbreite 550 mm Cassetto Premium 550 mm 80.42.301+ Contentitore per separazione rifiuti X55 L5 80.51.301 Sistema per guide cassetti esistenti, larghezza modulo 550 mm	80.50.302	40.002.276.00 L G	278.–	301.–
11 X55 M5 Premium, Einbauhöhe M, 367 mm Altezza d'ingombro M, 367 mm	Schublade Premium 550 mm 80.42.301+ Abfalltrennbehälter X55 M5 80.51.302 System für bestehende Schubladenauszüge Korpusbreite 550 mm Cassetto Premium 550 mm 80.42.301+ Contentitore per separazione rifiuti X55 M5 80.51.302 Sistema per guide cassetti esistenti, larghezza modulo 550 mm	80.50.304	40.002.277.00 L G	278.–	301.–
11 X60 L7 Premium, Einbauhöhe L, 414 mm Altezza d'ingombro L, 414 mm	Schublade Premium 600 mm 80.42.401+ Abfalltrennbehälter X60 L7 80.51.403 System für bestehende Schubladenauszüge, Korpusbreite 600 mm Cassetto Premium 600 mm 80.42.401+ Contentitore per separazione rifiuti X60 L7 80.51.403 Sistema per guide cassetti esistenti, larghezza modulo 600 mm	80.50.406	40.002.452.00 L G	249.–	269.–
11 X60 M7 Premium, Einbauhöhe M, 367 mm Altezza d'ingombro M, 367 mm	Schublade Premium 600 mm 80.42.401+ Abfalltrennbehälter X60 M7 80.51.404 System für bestehende Schubladenauszüge, Korpusbreite 600 mm Cassetto Premium 600 mm 80.42.401+ Contentitore per separazione rifiuti X60 M7 80.51.404 Sistema per guide cassetti esistenti, larghezza modulo 600 mm	80.50.408	40.002.453.00 L G	249.–	269.–
12 X60 L5 Premium, Einbauhöhe L, 414 mm Altezza d'ingombro L, 414 mm	Schublade Premium 600 mm 80.42.401+ Abfalltrennbehälter X60 L5 80.51.401 System für bestehende Schubladenauszüge, Korpusbreite 600 mm Cassetto Premium 600 mm 80.42.401+ Contentitore per separazione rifiuti X60 L5 80.51.401 Sistema per guide cassetti esistenti, larghezza modulo 600 mm	80.50.402	40.002.280.00 L G	278.–	301.–
12 X60 M5 Premium, Einbauhöhe M, 367 mm Altezza d'ingombro M, 367 mm	Schublade Premium 600 mm 80.42.401+ Abfalltrennbehälter X60 M5 80.51.402 System für bestehende Schubladenauszüge, Korpusbreite 600 mm Cassetto Premium 600 mm 80.42.401+ Contentitore per separazione rifiuti X60 M5 80.51.402 Sistema per guide cassetti esistenti, larghezza modulo 600 mm	80.50.404	40.002.281.00 L G	278.–	301.–

Müllex X-Line: Einzelkomponenten / Müllex X-Line: Componenti singoli

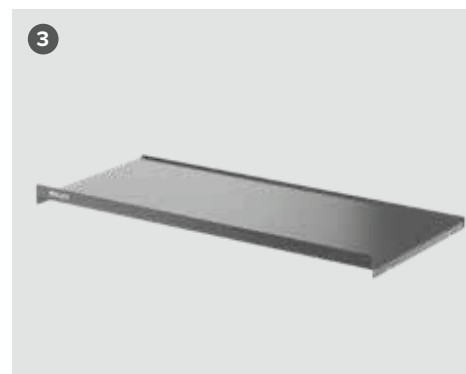

Preis CHF / Prezzo in CHF

Modell Modello	Beschreibung Descrizione	Müllex-Nr. N. di Müllex	Artikel-Nr. N. di articolo	Exkl. MWST IVA esclusa	Inkl. MWST IVA inclusa	
1	Schublade Basic Cassetto Basic 450 mm	Basic-Schublade für Abfall-System mit Korpusbreite 450 mm. B 404 × T 358 × H 50 mm, anthrazit, Kunststoff Cassetto Basic per sistema di raccolta rifiuti con larghezza modulo 450 mm. L 404 × P 358 × A 50 mm, antracite, plastica	80.41.101	40.002.254.00	35.–	38.–
	Schublade Basic Cassetto Basic 500 mm	Basic-Schublade für Abfall-System mit Korpusbreite 500 mm. B 454 × T 358 × H 50 mm, anthrazit, Kunststoff Cassetto Basic per sistema di raccolta rifiuti con larghezza modulo 500 mm. L 454 × P 358 × A 50 mm, antracite, plastica	80.41.201	40.002.255.00	35.–	38.–
	Schublade Basic Cassetto Basic 550 mm	Basic-Schublade für Abfall-System mit Korpusbreite 550 mm. B 504 × T 358 × H 50 mm, anthrazit, Kunststoff Cassetto Basic per sistema di raccolta rifiuti con larghezza modulo 550 mm. L 504 × P 358 × A 50 mm, antracite, plastica	80.41.301	40.002.256.00	35.–	38.–
	Schublade Basic Cassetto Basic 600 mm	Basic-Schublade für Abfall-System mit Korpusbreite 600 mm. B 554 × T 358 × H 50 mm, anthrazit, Kunststoff Cassetto Basic per sistema di raccolta rifiuti con larghezza modulo 600 mm. L 554 × P 358 × A 50 mm, antracite, plastica	80.41.401	40.002.257.00	35.–	38.–
2	Schublade Premium Cassetto Premium 550 mm	Premium-Schublade für Abfall-System mit Korpusbreite 550 mm. B 500 × T 357 × H 68 mm, anthrazit, Kunststoff inkl. 2 Einlegeschalen, Volumen 0,9+1,3 Liter Cassetto Premium per sistema di raccolta rifiuti con larghezza modulo 550 mm. L 500 × P 357 × A 68 mm, antracite, plastica incl. 2 piastre inseribili, volume 0,9+1,3 litri	80.42.301	40.002.258.00	81.–	88.–
	Schublade Premium Cassetto Premium 600 mm	Premium-Schublade für Abfall-System mit Korpusbreite 600 mm. B 550 × T 357 × H 68 mm, anthrazit, Kunststoff inkl. 2 Einlegeschalen, Volumen 0,9+1,3 Liter Cassetto Premium per sistema di raccolta rifiuti con larghezza modulo 600 mm. L 550 × P 357 × A 68 mm, antracite, plastica incl. 2 piastre inseribili, volume 0,9+1,3 litri	80.42.401	40.002.259.00	81.–	88.–
3	Deckel Basic Coperchio Basic 800 mm	Metaldeckel für Abfall-System mit Korpusbreite 800 mm. B 754 × T 362 × H 43 mm, anthrazit, Metall Coperchio in metallo per sistema di raccolta rifiuti con larghezza modulo 800 mm. L 754 × P 362 × A 43 mm, antracite, metallo	80.41.501	40.002.260.00	72.–	78.–
	Deckel Basic Coperchio Basic 900 mm	Metaldeckel für Abfall-System mit Korpusbreite 900 mm. B 854 × T 362 × H 43 mm, anthrazit, Metall Coperchio in metallo per sistema di raccolta rifiuti con larghezza modulo 900 mm. L 854 × P 362 × A 43 mm, antracite, metallo	80.41.601	40.002.261.00	72.–	78.–
4	Trennsteg X Separatore X	Der Trennsteg unterteilt einen 35 oder 40 Liter Hauptbehälter, so dass zwei 17 Liter Abfallsäcke eingespannt werden können. Il separatore divide il contenitore principale da 35 o 40 litri in modo da poter bloccare due sacchi di rifiuti da 17 litri.	12927	40.002.529.00	19.–	21.–

Müllex X-Line: Einzelkomponenten / Müllex X-Line: Componenti singoli



Preis CHF/Prezzo in CHF

Modell Modello	Beschreibung Descrizione	Müllex-Nr. N. di Müllex	Artikel-Nr. N. di articolo	Exkl. MWST IVA esclusa	Inkl. MWST IVA inclusa
5 Abfalltrennbehälter Contentore per separazione rifiuti X45 L35	Behälter für Abfall-System mit Korpusbreite 450 mm. Einbauhöhe L, 414 mm, Volumen 40 Liter, anthrazit, Kunststoff Contentore per sistema di raccolta rifiuti con larghezza modulo 450 mm. Altezza d'ingombro L, 414 mm, volume 40 litri, antracite, plastica	80.51.101	40.002.262.00 L G	144.–	156.–
5 Abfalltrennbehälter Contentore per separazione rifiuti X45 M35	Behälter für Abfall-System mit Korpusbreite 450 mm. Einbauhöhe M, 367 mm, Volumen 35 Liter, anthrazit, Kunststoff Contentore per sistema di raccolta rifiuti con larghezza modulo 450 mm. Altezza d'ingombro M, 367 mm, volume 35 litri, antracite, plastica	80.51.102	40.002.263.00 L G	144.–	156.–
6 Abfalltrennbehälter Contentore per separazione rifiuti X55 L7	Behälterkombination für Abfall-System mit Korpusbreite 550 mm. Einbauhöhe L, 414 mm, Volumen 40 + 12,5 Liter, anthrazit/ elfenbeinweiss, Kunststoff Combinazione di contenitori per sistema di raccolta rifiuti con larghezza modulo 550 mm. Altezza d'ingombro L, 414 mm, volume 40 + 12,5 litri, antracite/ bianco avorio, plastica	80.51.303	40.002.442.00 L G	168.–	182.–
6 Abfalltrennbehälter Contentore per separazione rifiuti X55 M7	Behälterkombination für Abfall-System mit Korpusbreite 550 mm. Einbauhöhe M, 367 mm, Volumen 35 + 11,5 Liter, anthrazit/ elfenbeinweiss, Kunststoff Combinazione di contenitori per sistema di raccolta rifiuti con larghezza modulo 550 mm. Altezza d'ingombro M, 367 mm, volume 35 + 11,5 litri, antracite/ bianco avorio, plastica	80.51.304	40.002.443.00 L G	168.–	182.–
7 Abfalltrennbehälter Contentore per separazione rifiuti X55 L5	Behälterkombination für Abfall-System mit Korpusbreite 550 mm. Einbauhöhe L, 414 mm, Volumen 40 + 4 + 4 + (1,4 + 1,4) Liter, anthrazit/ elfenbeinweiss, Kunststoff Combinazione di contenitori per sistema di raccolta rifiuti con larghezza modulo 550 mm. Altezza d'ingombro L, 414 mm, volume 40 + 4 + 4 + (1,4 + 1,4) litri, antracite/ bianco avorio, plastica	80.51.301	40.002.265.00 L G	197.–	213.–
7 Abfalltrennbehälter Contentore per separazione rifiuti X55 M5	Behälterkombination für Abfall-System mit Korpusbreite 550 mm. Einbauhöhe M, 367 mm, Volumen 35 + 4 + 4 + (0,9 + 0,9) Liter, anthrazit/ elfenbeinweiss, Kunststoff Combinazione di contenitori per sistema di raccolta rifiuti con larghezza modulo 550 mm. Altezza d'ingombro M, 367 mm, volume 35 + 4 + 4 + (0,9 + 0,9) litri, antracite/ bianco avorio, plastica	80.51.302	40.002.266.00 L G	197.–	213.–

Müllex X-Line: Einzelkomponenten / Müllex X-Line: Componenti singoli



Preis CHF / Prezzo in CHF

Modell Modello	Beschreibung Descrizione	Müllex-Nr. N. di Müllex	Artikel-Nr. N. di articolo	Exkl. MWST IVA esclusa	Inkl. MWST IVA inclusa
8 Abfalltrennbehälter Contenitore per separazione rifiuti X60 L7	Behälterkombination für Abfall-System mit Korpusbreite 600 mm. Einbauhöhe L, 414 mm, Volumen 40+18 Liter, anthrazit / elfenbeinweiss, Kunststoff Combinazione di contenitori per sistema di raccolta rifiuti con larghezza modulo 600 mm. Altezza d'ingombro L, 414 mm, volume 40+18 litri, antracite / bianco avorio, plastica	80.51.403	40.002.444.00 L G	168.–	182.–
Abfalltrennbehälter Contenitore per separazione rifiuti X60 M7	Behälterkombination für Abfall-System mit Korpusbreite 600 mm. Einbauhöhe M, 367 mm, Volumen 35+15 Liter, anthrazit / elfenbeinweiss, Kunststoff Combinazione di contenitori per sistema di raccolta rifiuti con larghezza modulo 600 mm. Altezza d'ingombro M, 367 mm, volume 35+15 litri, antracite / bianco avorio, plastica	80.51.404	40.002.445.00 L G	168.–	182.–
9 Abfalltrennbehälter Contenitore per separazione rifiuti X60 L5	Behälterkombination für Abfall-System mit Korpusbreite 600 mm. Einbauhöhe L, 414 mm, Volumen 40+8+5+(1,6+1,5) Liter, anthrazit / elfenbeinweiss, Kunststoff Combinazione di contenitori per sistema di raccolta rifiuti con larghezza modulo 600 mm. Altezza d'ingombro L, 414 mm, volume 40+8+5+(1,6+1,5) litri, antracite / bianco avorio, plastica	80.51.401	40.002.267.00 L G	197.–	213.–
Abfalltrennbehälter Contenitore per separazione rifiuti X60 M5	Behälterkombination für Abfall-System mit Korpusbreite 600 mm. Einbauhöhe M, 367 mm, Volumen 35+8+5+(1,0+0,5) Liter, anthrazit / elfenbeinweiss, Kunststoff Combinazione di contenitori per sistema di raccolta rifiuti con larghezza modulo 600 mm. Altezza d'ingombro M, 367 mm, volume 35+8+5+(1,0+0,5) litri, antracite / bianco avorio, plastica	80.51.402	40.002.268.00 L G	197.–	213.–
10 Abfalltrennbehälter Contenitore per separazione rifiuti X80 L6	Behälterkombination für Abfall-System mit Korpusbreite 800 mm. Einbauhöhe L, 414 mm, Volumen 40+18+8+5+(1,6+1,5) Liter, anthrazit / elfenbeinweiss, Kunststoff Combinazione di contenitori per sistema di raccolta rifiuti con larghezza modulo 800 mm. Altezza d'ingombro L, 414 mm, volume 40+18+8+5+(1,6+1,5) litri, antracite / bianco avorio, plastica	80.51.501	40.002.269.00 L G	256.–	277.–

Müllex BOXX / Comfort

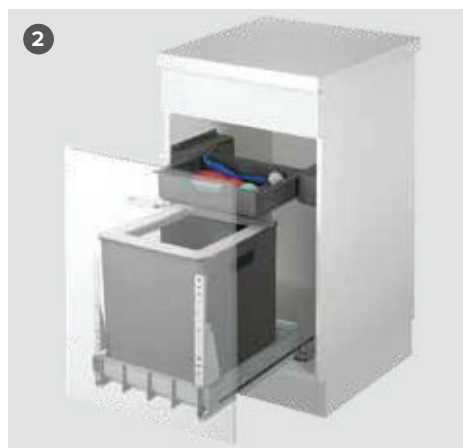

Preis CHF / Prezzo in CHF

Modell Modello	Beschreibung Descrizione	Müllex-Nr. N. di Müllex	Artikel-Nr. N. di articolo	Exkl. MWST IVA esclusa	Inkl. MWST IVA inclusa
1 Müllex BOXX 40-R	40-er und 50-er Korpus / inkl. Montageset / Netto Inhalt: 1×41l / Passend für: 35- und 17-Liter-Säcke Corpo da 40 e 50 cm / kit di montaggio incluso / contenuto netto: 1×41l / adatto per sacchi da 35 e 17 litri	5059.01	40.001.023.00	329.–	356.–
2 Müllex Euro BOXX 40-R	Speziell für EURO-Norm Küchen. Gleiche Ausführung wie oben. Specifico per cucine Euronorma. Modello come sopra.	5350.00	40.001.050.00	329.–	356.–
	Ablage-Adapter mittel, Paar 45 mm, für 45-er Korpus Coppia di adattatori da 45 mm per ripiano medio, per telaio da 45	11783	40.001.684.00	9.–	10.–
3 Müllex BOXX 55/60-R BIO	55-er und 60-er Korpus / inkl. Montageset / Netto Inhalt: 1×41l, 1×51l / Passend für: 35- und 17-Liter-Säcke Corpo da 55 e 60 cm / kit di montaggio incluso / contenuto netto: 1×41l, 1×51l / adatto per sacchi da 35 e 17 litri	5069.01	40.001.024.00	405.–	438.–
4 Müllex Euro BOXX 55/60-R	Speziell für EURO-Norm Küchen. Gleiche Ausführung wie oben. Mit 16-Liter Beistellbehälter anstelle Grünkübel und Zusatzbehälter. Specifico per cucine Euronorma. Modello come sopra. Con contenitore da 16 litri invece del secchio verde e del contenitore supplementare.	5360.00	40.001.051.00	376.–	406.–
5 Müllex Comfort 35/5	Ab 55-er Korpus / inkl. Montageset / Netto Inhalt: 1×35l, 1×5l, 2×4l / Passend für: 35-Liter-Säcke Corpo da 55 cm / kit di montaggio incluso / contenuto netto: 1×35l, 1×5l, 2×4l / adatto per sacchi da 35 litri	4950.40.992	40.000.271.00	349.–	377.–
Zubehör Accessori	Kick Matic zu Auszugssystem für Müllex BOXX / Comfort Kick Matic per sistema di estrazione per Müllex BOXX / Comfort	5019.70	40.000.757.00	80.–	86.–
	Stop Matic zu Auszugssystem für Müllex Comfort Stop Matic per sistema di estrazione per Müllex Comfort	4619.90	40.000.758.00	32.–	35.–

Müllex Heavy Bag





Die selbststehenden Heavy Bag Wertstoffsammeltaschen können in Küche, Vorratsraum, Waschküche, Garage oder Gartensitzplatz eingesetzt werden. Unentbehrlich für Haushalt und Alltag, wenn es um die sinnvolle Sammlung von Wertstoffen geht: Glas, Karton, Papier, Blechdosen, PET und vieles mehr.

Le borse autoportanti Heavy Bag per la raccolta differenziata dei rifiuti sono utilizzabili in qualsiasi ambiente: cucina, dispensa, lavanderia, garage o angolo relax nel giardino. Indispensabili nell'uso quotidiano e nel governo della casa per una raccolta razionale di materiali riciclabili come vetro, cartone, carta, lattine, PET e molto altro.

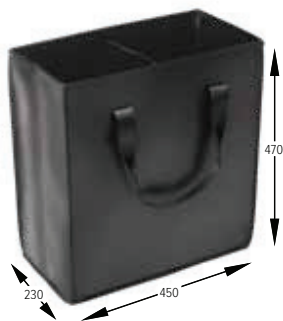
- selbststehend
- vielseitig einsetzbar
- hochwertige LKW-Blache
- 40 kg belastbar
- leicht zu reinigen
- autoportanti
- per un uso polivalente
- in tela da camion di alta qualità
- capacità di carico di 40 kg
- di facile pulizia



Preis CHF / Prezzo in CHF

Modell Modello	Beschreibung Descrizione	Dimensionen* Dimensioni*	Artikel-Nr. N. di articolo	Exkl. MWST IVA esclusa	Inkl. MWST IVA inclusa
1 Müllex Heavy Bag	Wertstoffsammeltasche ohne Trennfach, schwarz, matt Borsa per la raccolta differenziata senza divisorio, nero opaco	450 × 230 × 470	40.001.881.00  G	39.90	43.–
2 Müllex Heavy Bag	Wertstoffsammeltasche mit Trennfach, schwarz, matt Borsa per la raccolta differenziata con divisorio, nero opaco	450 × 230 × 470	40.001.882.00  G	39.90	43.–

* Dimensionen in mm / Dimensioni in mm

Masszeichnungen / Disegni tecnici

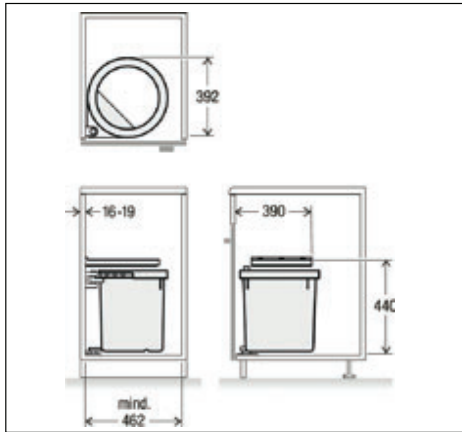

1 D-Line D50 L1

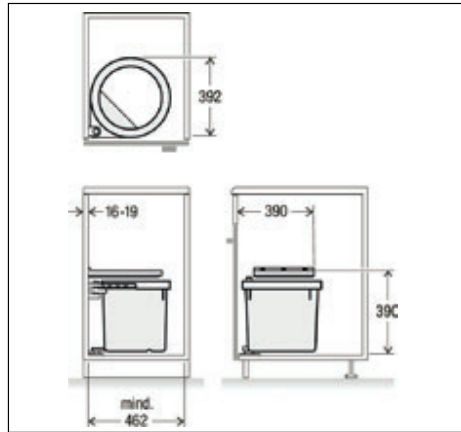

2 D-Line D50 M1

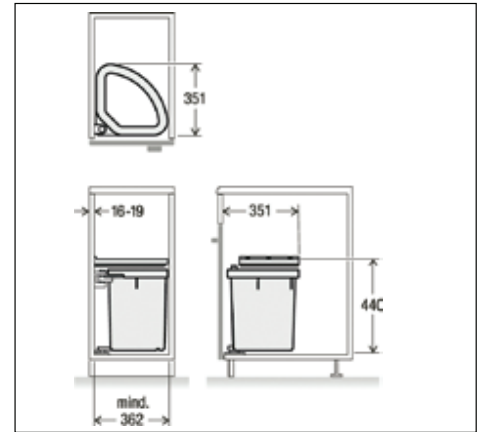

3 D-Line D40 L3

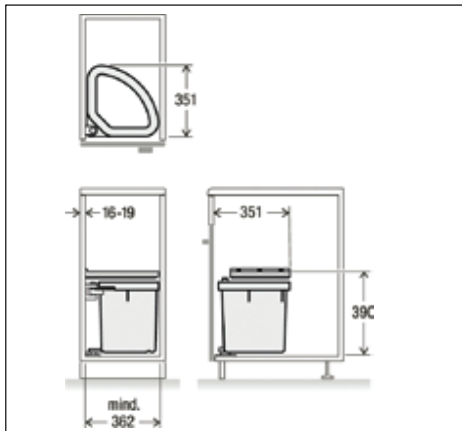

4 D-Line D40 M3

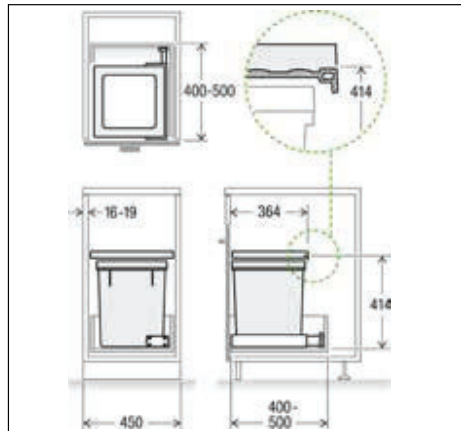

1 X-Line X45 L35 Basic

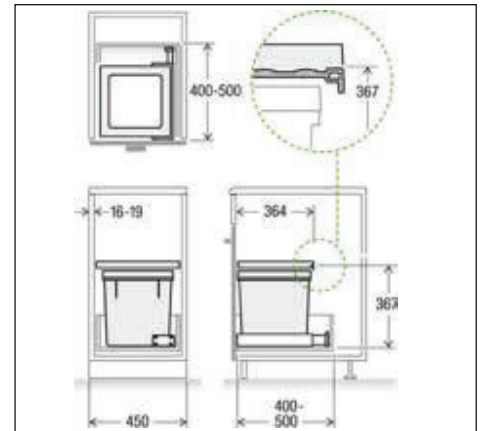

1 X-Line X45 M35 Basic

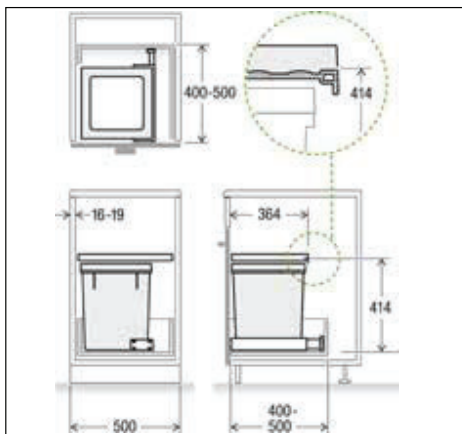

2 X-Line X50 L35 Basic

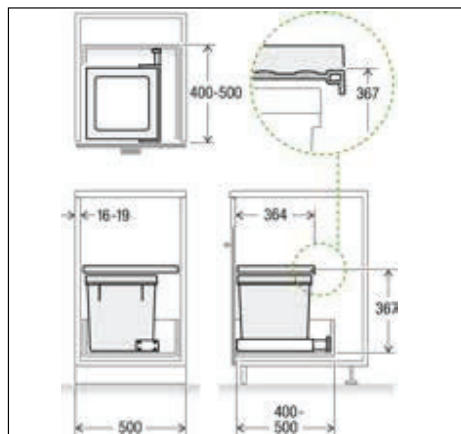

2 X-Line X50 M35 Basic

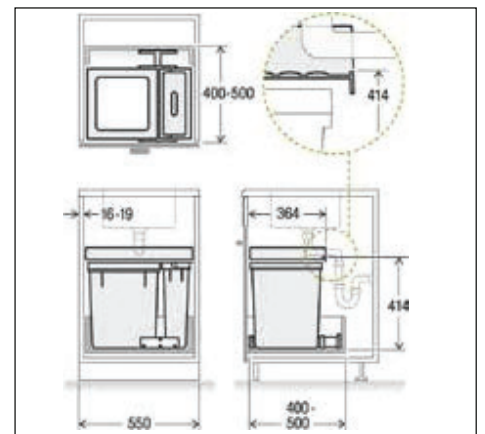

3 X-Line X55 L7 Basic

9 X-Line X55 L7 Premium

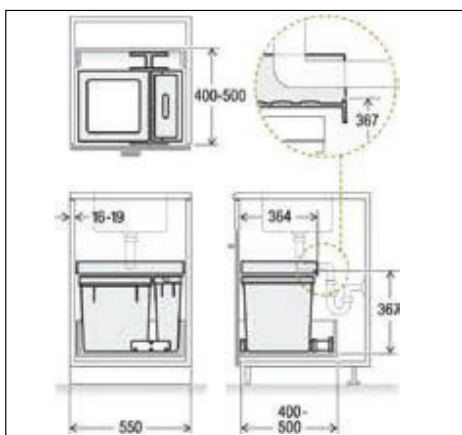

3 X-Line X55 M7 Basic

9 X-Line X55 M7 Premium

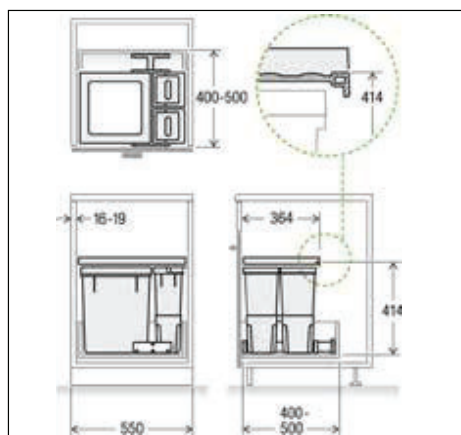

4 X-Line X55 L5 Basic

10 X-Line X55 L5 Premium

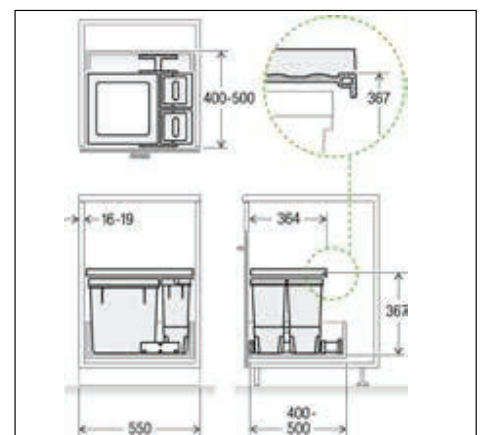

4 X-Line X55 M5 Basic

10 X-Line X55 M5 Premium

Masszeichnungen / Disegni tecnici

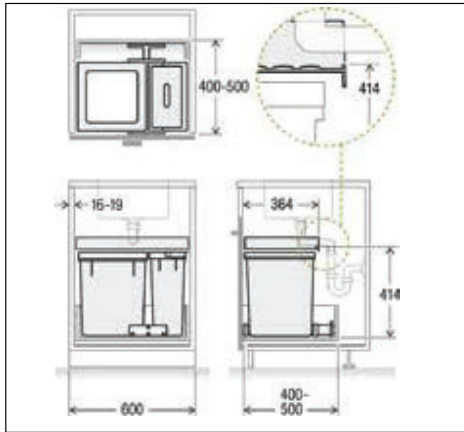

5 X-Line X60 L7 Basic 11 X-Line X60 L7 Premium

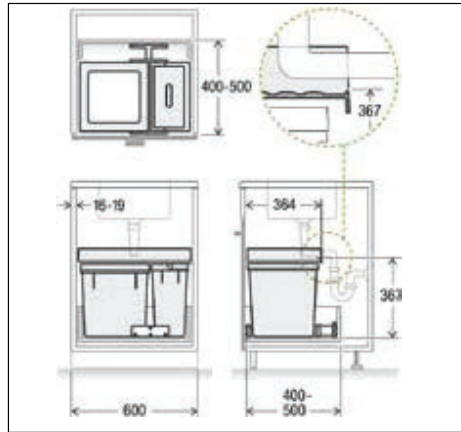

5 X-Line X60 M7 Basic 11 X-Line X60 M7 Premium

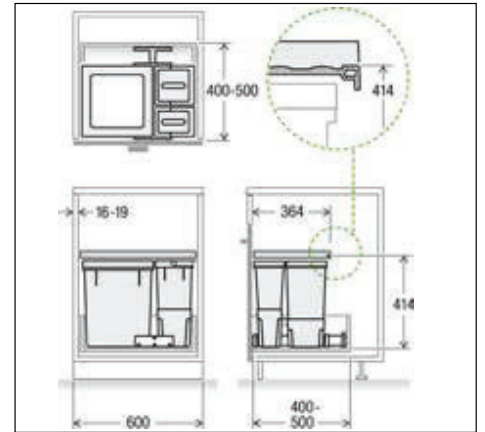

6 X-Line X60 L5 Basic 12 X-Line X60 L5 Premium

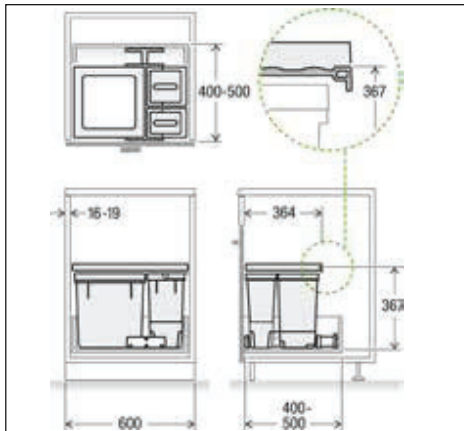

6 X-Line X60 M5 Basic 12 X-Line X60 M5 Premium

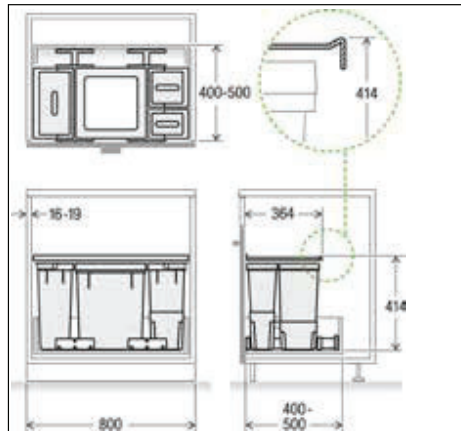

7 X-Line X80 L6 Basic

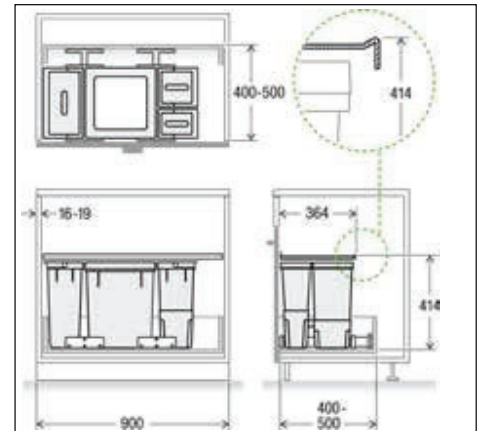

8 X-Line X90 L6 Basic

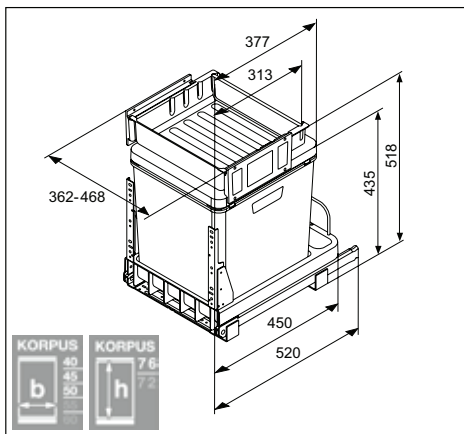

1 Müllex BOXX 40-R

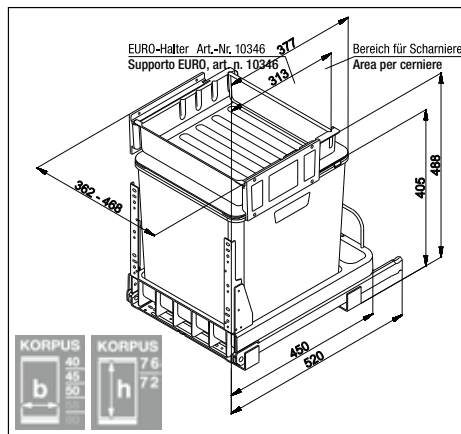

2 Müllex Euro BOXX 40-R

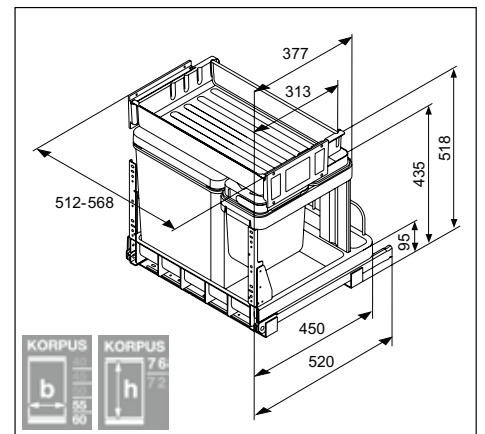

3 Müllex BOXX 55/60-R Bio

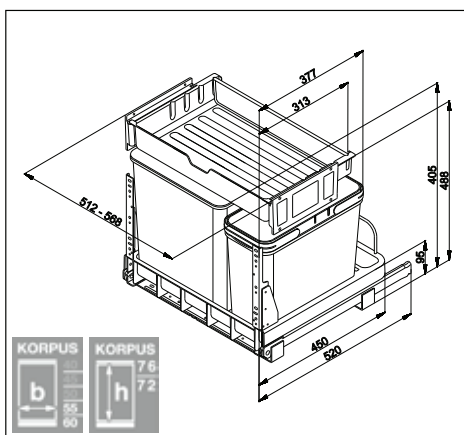

4 Müllex Euro BOXX 55/60-R

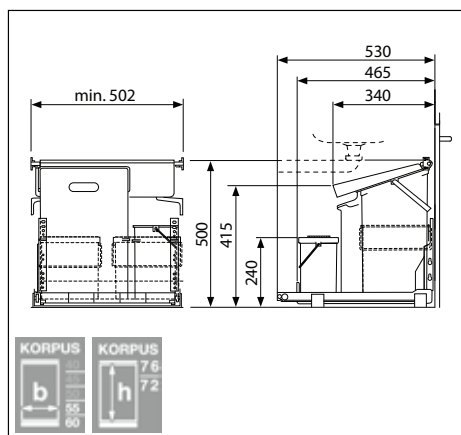

5 Müllex Comfort 35/5

Varianteencode – Sie haben die Wahl

Codice variante: a voi la scelta

Mit dem Varianteencode bieten wir Ihnen mehr Kombinationsmöglichkeiten bei der Wahl der Ventile: Andere Zugknöpfe, andere Farben oder gleich beides? So funktioniert's:

Grazie al codice variante, vi offriamo più opzioni di combinazione nella scelta delle pilette: altri pomoli, altri colori o entrambi? Ecco come funziona:

Sie erkennen den **Standardlieferungsumfang** der Suter Spülen und Becken am erweiterten Artikelcode xx.xxx.xxx.**00**. Die Ventilteile werden in Edelstahl geliefert, mit Zugknopf Advant, Prime oder Drehknopf.

Il codice articolo esteso xx.xxx.xxx.**00** è un codice per riconoscere il **corredo di fornitura standard** dei lavelli Suter. Le pilette sono fornite in acciaio inox, con pomolo Advant, Prime o pomolo girevole.

Variante **.01**



Austausch Zugknopf Sostituzione del pomolo

Bestellen Sie die Spülen oder Becken mit der Variantenerweiterung xx.xxx.xxx.**01**.

- Die Ventilbestandteile liefern wir in der Oberfläche Edelstahl.
- Austausch des Standard Zugknopfes mit dem Modell Ihrer Wahl (wählen Sie hier ein Modell mit der Erweiterung der Artikelnummer xx.xxx.xxx.**01**).
- Der Preis des Austausch-Zugknopfs reduziert sich um CHF 24.–.

Ordinate i lavelli con la variante estesa xx.xxx.xxx.**01**.

- Forniamo i componenti piletta con superficie in acciaio inox.
- Sostituzione del pomolo standard con un modello di vostra scelta (selezionate un modello con l'estensione del numero di articolo xx.xxx.xxx.**01**).
- Il prezzo del pomolo di ricambio si riduce di CHF 24.–.

Variante **.02**



Austausch Ventilbestandteile Sostituzione dei componenti piletta (Farbwechsel / cambio di colore)

Bestellen Sie die Spülen oder Becken mit der Variantenerweiterung xx.xxx.xxx.**02**.

- Die Ventilbestandteile mit der Oberfläche Edelstahl werden nach Ihrer Wahl ausgetauscht.
- Ersatz beschichtete Ventilbestandteile finden Sie auf Seite 192 und 198 (wählen Sie hier die Modelle mit der Artikelnummer xx.xxx.xxx.**00**).
- Die Preise beinhalten den Mehrpreis für die beschichteten Ventilbestandteile gegenüber des Standards mit Oberfläche Edelstahl.

Ordinate i lavelli con la variante estesa xx.xxx.xxx.**02**.

- I componenti piletta con superficie in acciaio inox vengono sostituiti in base alla vostra scelta.
- Trovate i componenti piletta sostitutivi con rivestimento a pagina 192 e 198 (selezionate qui i modelli con il numero di articolo xx.xxx.xxx.**00**).
- I prezzi includono il sovrapprezzo per i componenti piletta con rivestimento rispetto alla superficie standard in acciaio inox.

Variante **.03**

Austausch Zugknopf und Ventilbestandteile Sostituzione del pomolo e dei componenti piletta

Bestellen Sie das Becken mit der Variantenerweiterung xx.xxx.xxx.**03** und Ihre gewünschten Bestandteile wie beschrieben bei den Varianten **.01** und **.02**.









Ordinate il lavello con la variante estesa xx.xxx.xxx.**03** e i componenti desiderati come descritto per le varianti **.01** und **.02**.



Zeichenlegende Legenda







Allgemein

In generale

-  Neuheit 2024
Novità 2024
-  Hinweis
Nota
-  Zusätzliche Information
Informazioni supplementari
-  Artikel wird ab Lager geliefert
Articolo consegnabile da magazzino
-  Solange Vorrat
Fino ad esaurimento scorte
-  Unterschrankmasse in cm
Dimensioni base in cm
-  Barrierefrei
Senza barriere
-  Erdungskabel an der gekennzeichneten Position montieren
Montare il cavo di terra nella posizione contrassegnata







Ablauf- und Überlauf

Troppopieno e scarico

-  Desino: Verdeckter Ablauf mit untenliegendem Sieb
Desino: Scarico coperto con griglietta inferiore
-  Obenliegendes Sieb
Griglietta superiore
-  TouchFlow-Ventil
Piletta TouchFlow
-  eFlow mit eControl
eFlow con eControl
-  Schwenkbare Überlaufkappe
Placchetta di troppopieno a ribalta
-  Verdeckter Überlauf
Troppopieno coperto











Dispenser und Zugknöpfe

Distributori e Pomoli

-  Dispenser: alle Modelle
Distributori: tutti i modelli
-  Dispenser: kein Einbau möglich
Distributori: Nessun montaggio possibile
-  Dispenser: frei positionierbar
Distributori: posizione a scelta
-  Advant: Im Standard-Lieferumfang enthalten
Advant: Compreso nella fornitura standard
-  Prime: Im Standard-Lieferumfang enthalten
Prime: Compreso nella fornitura standard
-  Drehknopf
Pomolo girevole





Einbauarten und Kanten

Montaggio e bordi

-  Von oben
Dall'alto
-  Flach aufliegend
Soprapiano
-  Flächenbündig
A filo top
-  Von unten
Dal basso
-  Flächenbündig eingeschweisst
A filo top termosaldato
-  Kante mit Fase 0,5/45°
Bordo con smusso 0,5/45°
-  Kante mit Fase 1,0/45°
Bordo con smusso 1,0/45°
-  Kante mit Fase 1,5/45°
Bordo con smusso 1,5/45°
-  Kante ohne Fase (Radius)
Bordo senza smusso (raggio)
-  Ohne Fase (gebrochen)
Senza smusso (spezzato)

Montage

Montaggio

-  Ventilmontage ab Werk
Montaggio della piletta in fabbrica
-  Ventilvormontage ab Werk
Premontaggio della piletta in fabbrica
-  Ohne Ventilmontage
Senza montaggio della piletta
-  Spülentyp ist mit Klick-Montage für «Holz» oder «Stein» erhältlich. Bitte Typ bei der Bestellung angeben.
Tipo di lavello disponibile con montaggio a scatto per «legno» o «pietra». In sede di ordine, si prega di indicare il modello.



Zeichenlegende umseitig

Legenda dei segni a tergo



SUTER

Die Welt des Edelstahls – online erkunden! Il mondo dell'acciaio inox – scopritelo online!

Ihre Lieblingsprodukte, Zubehör und Ersatzteile sind nur einen Klick entfernt.
I vostri prodotti preferiti, gli accessori e i ricambi sono a portata di clic.



Geniessen Sie die Bequemlichkeit, rund um die Uhr online einzukaufen.
Erleben Sie, wie einfach es ist, hochwertige Edelstahlprodukte zu finden.
Willkommen bei suter.ch – wo Innovation und Einfachheit aufeinandertreffen!

Godetevi la comodità di fare acquisti online 24 ore su 24.
Scoprite quanto sia facile trovare prodotti in acciaio inox di alta qualità.
Benvenuti su suter.ch, dove innovazione e semplicità s'incontrano!



Das Preisbuch im neuen Design Il catalogo prezzi con un nuovo design

Auf der letzten Innenseite finden Sie neu einen Ausklapper, der Ihnen bei der Navigation mit Piktogrammen und Varianten helfen soll. Ausklappen und komfortabel planen!

Nell'ultima pagina interna ora trovate un nuovo pieghevole che vi aiuta nella navigazione con pittogrammi e varianti. Apritelo e pianificate con facilità!

SUTER

Suter Inox AG

Schachenstrasse 20
CH-5116 Schinznach-Bad

T +41 58 263 64 00

suter@suter.ch
suter.ch

Hauptsitz und Ausstellung Schinznach-Bad**Sede e l'esposizione Schinznach-Bad**

Schachenstrasse 20
CH-5116 Schinznach-Bad

T +41 58 263 64 00

Filiale und Ausstellung Zürich**Filiale e esposizione di Zurigo**

Hardturmstrasse 125
CH-8005 Zürich

T +41 58 263 64 02

Filiale und Ausstellung Crissier**Filiale e esposizione di Crissier**

Chemin des Lentillières 15
CH-1023 Crissier

T +41 58 263 64 03

Bestellungen

T +41 58 263 64 20
bestellungen@suter.ch

Bestellungen Massanfertigung

T +41 58 263 64 40
bestellungen_ma@suter.ch

Offerten

T +41 58 263 64 60
offerten@suter.ch

Kundendienst

T +41 58 263 64 80
kundendienst@suter.ch

Ordinazioni

T +41 58 263 64 20
ordinazioni@suter.ch

Ordinazioni soluzioni a misura

T +41 58 263 64 40
ordinazioni_ma@suter.ch

Offerte

T +41 58 263 64 60
offerte@suter.ch

Servizio clienti

T +41 58 263 64 80
servizioclienti@suter.ch

